

# Product Catalog

Strength Through Innovation Since 1764

---



**GUNNEBO**  
Industries

# Innovation with Passion, Peace of mind & Performance

*Gunnebo Industries live and breathe quality. For over 250 years we have developed and manufactured premium products of outstanding quality to industries within manufacturing, construction, oil & gas, offshore, fishing, and aquaculture worldwide.*

The harsh environments of these industries result in high demands on the equipment used, and the safety and reliability of our products are essentially what have positioned us as a premium producer over the years. At Gunnebo Industries our products are developed, manufactured and tested beyond the highest standards, and we take a long-term responsibility for our products and services. We are passionate about developing products for our customers' needs that are safe and reliable, today and in the future.

We believe the key to innovation is to truly understand the customers' needs and to continuously improve our products, services and processes. Every employee at Gunnebo Industries strives to provide excellent support and service, and we take great pride in what we do.

Our expertise, knowledge, commitment and long experience is something extraordinary; we are there every step of the way to help our customers be successful in their business.

We deliver quality and innovation with passion, peace of mind and performance  
– to every part of the world.

## Our Vision

*"Gunnebo Industries is the preferred partner in lifting and related applications for customers throughout the world. We are known for our innovative, safe and reliable products and our excellent support and service."*

## Our Mission

*"We will always make our products readily available regardless of where in the world they are needed through a worldwide network of experienced expertise, including our sales offices, partners and distributors."*

## Our Core Values

Passion ● Peace of mind ● Performance

An offshore oil rig is shown at sea, with a large white vessel and a dark structure. A crane is lifting a large, dark, rectangular object from the rig. The scene is set against a backdrop of a blue sky and dark sea.

## Passion

Proactivity

●  
Extraordinary commitment

●  
Responsible and trustworthy

A construction site is shown with several tall cranes and a large building under construction. The scene is set against a backdrop of a blue sky and a city skyline.

## Peace of mind

Extensive technical expertise

●  
Outstanding quality

●  
Long term vision

An offshore aquaculture site is shown in a body of water, with several large, circular structures. The scene is set against a backdrop of a blue sky and a rocky coastline.

## Performance

Identify needs and provide solutions

●  
Operational excellence

●  
Continuous improvements



# Company Information & Services

Introduction • About our Products • Gunnebo Industries Training Program

1

# Sling Components

Grade 10 • Offshore • Grade 8 • Hot Dip Galvanized

2

# Lifting Points

Rotating • Ball-bearing • De-centered • Weldable • Screw-on

3

# Shackles & Rigging Screws

Dee and Bow Shackles • Arctic Shackles • Aquaculture • Stainless Steel Shackles

4

# Chain

Grade 10 • Grade 8 • Short Link • Mid-link • Long-link

5

# Johnson Products

Crane Blocks • Snatch Blocks • Oilfield Blocks • Swivels  
• Custom Engineered Products

6

# Johnson Sheaves

Forged Sheaves • Cast Sheaves • Machined Sheaves

7

# Lashing Components

Chain Tensioner • Other Lashing Products

8

## WARNING:

Failure to read, understand and comply with the instructions, working load limits and specifications in this publication may result in serious injury or damage to property.

Where there is growth and development in the world...

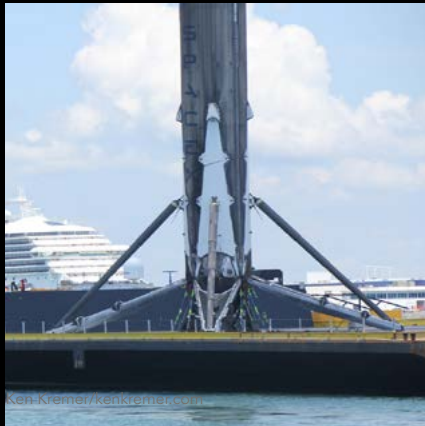

...Gunnebo Industries products can be found.



**GUNNEBO**  
Industries

## Company information and services









About our products	1:6 - 1:7
Global presence & contacts	1:8 -1:9
Gunnebo Industries training	1:10 - 1:11



# A legacy of innovation

In 1764 Hans Hultman founded Gunnebo Industries in the shape of a hammer-smithy in Småland, Sweden. Today we are an international corporation, well known in many industries all over the world.

Gunnebo Industries continuously drives innovation through product development to create the optimal solutions for each lifting situation. Since the early 1950's we have developed products that are today's standards on the market and copied by almost all manufacturers of lifting equipment. There is however only one original - Gunnebo Industries. With the original you get the perfect fit and clever details.

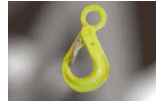
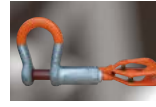
<b>1952</b> G-coupler 	<b>1970s</b> Unique sheave process 	<b>1990s</b> Johnson Quick Reeve Crane Blocks 	<b>2005</b> Midgrab chain shortener 	<b>2010</b> MFH and the Arctic master link 		
<b>1764</b>	<b>1965</b> BK-hook 	<b>1975</b> UKN-hook 	<b>2000</b> GrabIQ system - grade 10 	<b>2008</b> BKD 	<b>2015</b> The ROV retrieve Shackle 	<b>2019</b>

## Unique quality process for our chain & lifting components

### Traceability Code

The traceability code consists of letters and numbers that identifies exactly which plant the product was made in, the year and the batch. This gives us the ability to trace the product back through the manufacturing process, all the way back to the specific raw material.

### Approved by BG/DGUV

Our products have the H32-stamp which means that they are manufactured and approved in accordance to the rules of Die Berufsgenossenschaft Handel und Warenlogistik (BGHW). This is a proof of quality and ensures that the product contributes to the safest possible working environment for both personnel and load.

### Quality Assurance

All forged parts and every chain link are 100% proof loaded during our manufacturing process.

### Manufacturer Name

All our forged components are marked with "Gunnebo Sweden".

### Component Type, Size and Grade

The size and grade is clearly marked on each component, to avoid errors and ensures correct matching of chain and components.

### High Quality Steel

Our components and Chain are manufactured only from steel from European suppliers with 100% traceability and quality assurance.

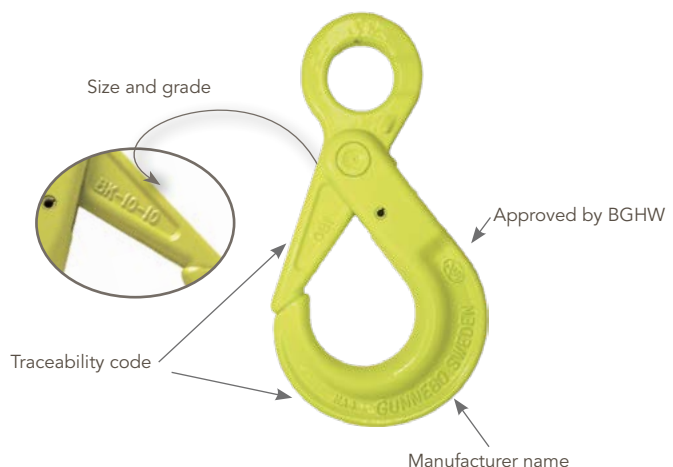



# Wide range of products and applications

1



## The GrabiQ System

By integrating shortening into our top fitting, our GrabiQ Grade 100 range weighs up to 40% less than traditional chain slings while delivering more flexibility. This provides a cost effective modular system that covers a broad range of lifting applications.

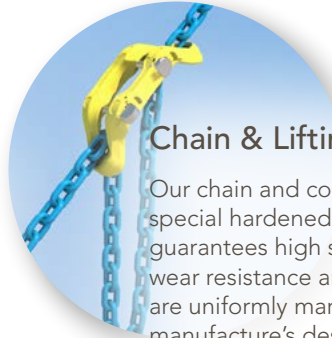

## Chain & Lifting Components

Our chain and components are made from special hardened and tempered alloy steel that guarantees high strength, low weight, high wear resistance and long life. All components are uniformly marked with chain size, grade, manufacture's designation and name. Every component is tested to the Manufacturing Proof Force before leaving our factories in Sweden.



## Lifting Points

Our wide range of lifting points allow us to provide complete solutions developed for each customer's needs, enabling improved operational efficiency for our customers. All of our Lifting Points are CE marked. Each lifting point has been proof loaded to 2.5 times the Working Load Limit and visually inspected by a licensed inspector before leaving the factory.



## Shackles & Rigging Screws

Our shackles are available in a broad range of steel including acid proof stainless steel and high grade alloy steel to comply with the most stringent specifications. Several of our shackles are also Type Approved to DNV 2.7-1. The production of shackles and rigging screws takes place in our factory located outside Bergen, Norway.



## Johnson Products

Johnson products – An extensive product line including crane blocks, overhaul balls, snatch blocks, swivels and wedge sockets. Stringent quality controls make our products the standard of choice in the industry. All Johnson products are manufactured in our own factory in Tulsa, Oklahoma USA.



## Johnson Sheaves

We develop and manufacture sheaves for all purposes. Our sheaves are made of high-strength materials and designed to optimize performance and quality. With production facilities in USA and Europe, we serve customers on a global scale, always close, for the best possible support.



## Aquaculture

Our maritime products are made for a life under water. For example, our Hot Dip Galvanized (HDG) lifting range is designed to meet the specific challenges from corrosive environments in which they will have a longer lifetime, which means that the HDG products are more cost effective in the long run.



## Arctic Offshore

Adverse weather and rough sea conditions, sometimes in combination with extremely low temperatures, must be included in the design of offshore lifting sets. Our offshore range is produced from steel that gives improved impact strength at low operating temperatures, as well as reduced risk for hydrogen embrittlement.

# Global presence

Sales offices in 9 countries • Distributors in more than 50 additional countries.

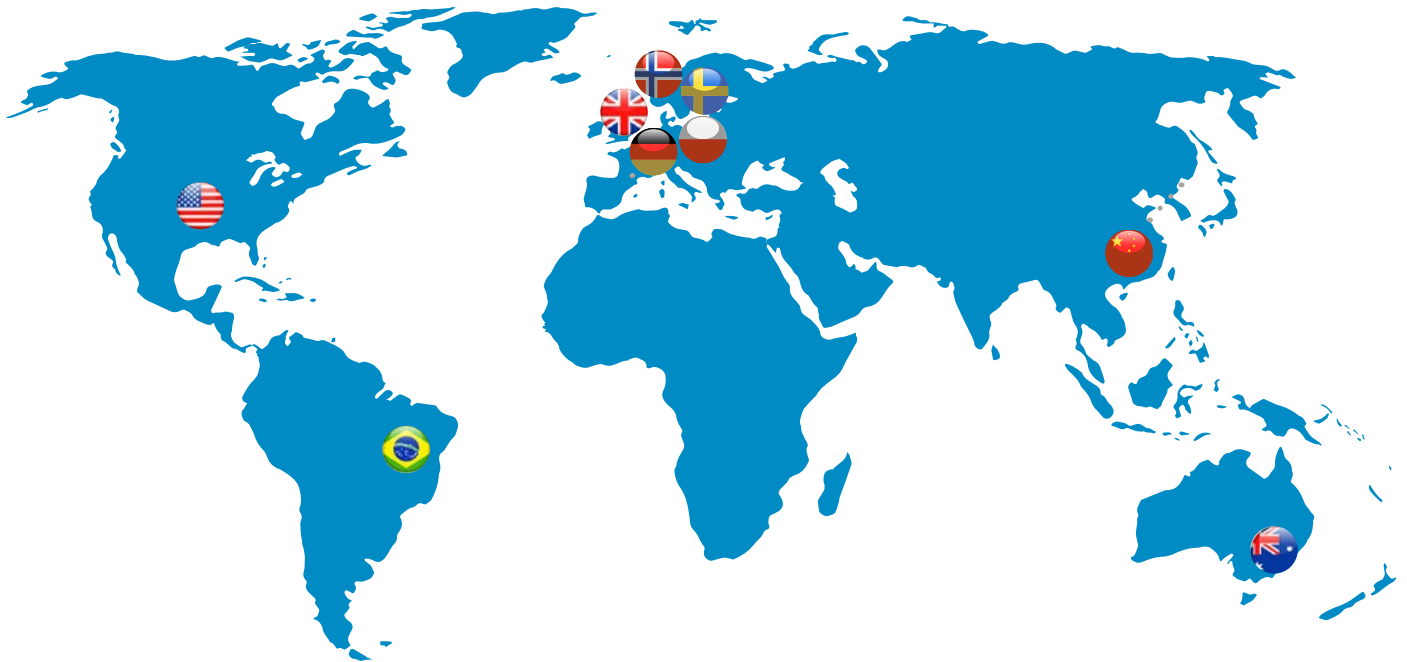

# Production plants

Four production facilities in Sweden, Norway and USA.



# Quality, technology & innovation

## Outstanding quality level

- All relevant certification standards including DNV, NS9415 as well as ISO 14001:2015 and 9001:2015.
- Unique practice consisting of 100% testing and full traceability.
- All products are proof loaded to 200-250% of the working load limit.
- Extensive testing and inspection process.

## World-class manufacturing process

- Automated state-of-the-art production sites.
- Fully integrated manufacturing process with all critical processes in-house.
- Full traceability from finished product to raw material.

## Technical expertise

- System design creating operational efficiency through time and weight savings, as well as increased flexibility.
- Design expertise and outstanding customer service.
- Our own R&D department.

## Heritage of innovation

- Many of the products that are today's industry standard have been developed by Gunnebo Industries, with innovation since 1764.



# Training



## Knowledge lifts loads off your mind

We strive to ensure that you are able to use and handle our products correctly and safely. In order to do so, we have developed a number of customer training programs. The courses are presented by our highly qualified staff, often on site together with customers.

We offer a range of training sessions that will increase both your knowledge of our products and how to handle them safely and correctly, as well as give you sales tips on selling in a very competitive market.

Our technical courses will not only help to create a safer working environment, but also increase the life span of our products.

After successful completion of the course, each participant will receive a Certificate, detailing the knowledge achieved.



## Target groups for Gunnebo Industries courses are:

- Gunnebo Industries distributors
- Purchasing personnel
- Safety personnel
- Rigging supervisors
- Users of Rigging

## Training courses

---

### Technical training

Level 1	<ul style="list-style-type: none"><li>• Company information</li><li>• Current relevant legislation</li><li>• Lifting equipment selection</li><li>• Sling configuration including the GrabiQ system</li><li>• Gunnebo Industries products</li><li>• Shackle program</li><li>• Blocks and sheaves Program</li></ul>
---------	---

Level 2	<ul style="list-style-type: none"><li>• More detailed Level 1 information</li><li>• Safe use of lifting equipment</li><li>• Gunnebo manufacturing process</li><li>• Practical handling and sling assembly</li><li>• Inspection and maintenance</li></ul>
---------	--

### Sales Training

	<ul style="list-style-type: none"><li>• Company information</li><li>• Sales training</li><li>• Sales promotion methods</li><li>• Practical tips on technical sales</li></ul>
--	--

## Training locations

- Gunnebo Industries global subsidiaries
- Gunnebo Industries main distributor centers
- On-site at suitable training centers

## Post course information service

All participants can also request of technical advice and information from instructor after completion of the course.

## Course dates and schedules

For more information and course dates, please contact us at [export@gunneboindustries.com](mailto:export@gunneboindustries.com) or contact any of our sales teams.

# Sling Components

Grade 10 • Offshore • Grade 8 • Hot Dip Galvanized



## GrabiQ

GrabiQ System	2:2
FlexiLeg	2:4
GrabiQ Solutions	2:5 - 2:6
Pre-Assembled Chain Sling	2:7
Chain Shortener, MIG	2:8
Master Links, GrabiQ	2:9 - 2:11
Coupling Link, G, GrabiQ	2:11
C-Grab, GrabiQ	2:12
C-Lok	2:12
Chain, GrabiQ	2:13
Grab Hooks	2:14
Safety Hooks, Clevis, GrabiQ	2:15
Safety Hooks, Eye GrabiQ	2:15 - 2:17
Safety Hook, Shank, GrabiQ	2:17
Safety Hooks, Swivel, GrabiQ	2:18
Sling Hooks, Clevis, GrabiQ	2:19
Sling Hook, Eye, GrabiQ	2:19
Foundry Hook, OKE, GrabiQ	2:20
Swivel Latch Hooks, GrabiQ	2:20
Round Sling Hook, RH	2:21
Container Hook, CH, GrabiQ	2:21

## Offshore

Master Links, Offshore	2:24 - 2:25
Safety Hooks, Offshore	2:26
Double Latch Hook, Offshore	2:26
WRIN STR Safety Handle	2:27

## Classic

SK-system, Classic	2:29
SK Products, Classic	2:30 - 2:31
Universal Weld-on Hook, Classic	2:32
Master Links, Classic	2:33
Coupling Links, Classic	2:33
Berglok Chain Coupler BL	2:34
Clevis Shackle GSA	2:34
Chain, Classic	2:34
Grab Hook, OG, Classic	2:35
Safety Hooks, Classic	2:35 - 2:36
Sling Hooks, Classic	2:35 - 2:36
Swivel Safety Hooks, Classic	2:36
Container Hook, Classic	2:37
Clevis Egglink, CEL, Classic	2:37
Foundry Hook, OKE, Classic	2:37
Coupling Link GF Stainproof	2:37

## Hot Dip Galvanized

Master Link MF HDG	2:39
Chain KLZ HDG	2:39
Safety Hook BK HDG	2:39
Swivel Safety Hook BKL HDG	2:39
Coupling Link G HDG	2:39

## Spare Parts

Spare Parts	2:40 - 2:44
-------------	-------------

## Technical Information

Safe Use and Maintenance	2:46 - 2:48
Quality Assurance	2:49
Working Load Limits	2:50

**WARNING:**  
Failure to read, understand and comply with the instructions, working load limits and specifications in this publication may result in serious injury or damage to property.

# Increase Efficiency and Reduce Cost

*Our GrabiQ chain sling system for coupling, shortening and lifting in grade 10 is designed to integrate multiple functions in each component.*

## GrabiQ – Quicker, safer and easier lifting operations

- **Intelligent design:**  
Efficient and ergonomic lifts.
- **Multiple functions in each component:**  
Fewer components in each sling, resulting in cost effective lifting operations.
- **Built in shortening function:**  
Allows the user to instantly adjust the chain sling.
- **Grade 10:**  
25 % added strength compared to grade 8.
- **Less weight**  
Up to 40% lighter than traditional slings for easier handling and use.
- **High quality:**  
All products are proof loaded and visually inspected.



**GrabiQ**<sup>TM</sup>



# Components with Multiple Functions

*Innovative designs that combines several clever functions in one component.*



2

## Midgrab, MIG

- Instant mounting, positioning, shortening on any part of the chain.

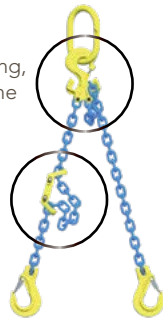

## C-grab Duo, CGD

- Built in shortening function.



## Master Grab, MG

- "All-in-one" compact top link
- Every chain leg can instantly be altered.
- Using the built in shortening function you can alter between a straight lift to a looped sling in a matter of seconds.

# Fewer Components with GrabiQ

*With GrabiQ the number of components and the weight is significantly reduced:*

## 4-leg sling with shortening function



- 1 Master link
- 2 C-grab Duo

**Total:**  
3 GrabiQ components



- 1 Master link with 2 Sublinks
- 8 Berglok Chain Couplers
- 4 Grab Hooks

**Total:**  
15 components

## 2-leg sling with shortening function



- 1 Master Grab Duo

**Total:**  
1 GrabiQ component



- 1 Master link
- 4 Berglok Chain Couplers
- 2 Grab Hooks

**Total:**  
7 components

# Less is More with FlexiLeg

Thanks to the unique features of our GrabiQ product range we can offer solutions that increase the flexibility in lifting operations even further. Our FlexiLeg solution allows you to have an instant leg change onsite. With one single master link in combination with five Flexi-legs we offer a solution that replaces four complete traditional slings, a total of ten legs. In addition to this FlexiLeg also gives you the opportunity to modify the chain sling to different lifting operations, whenever and wherever it is needed.

## The Benefits of Instant Leg-Change

- It enables the user to change slings, leg by leg.
- It makes the sling lighter and easier to work with.
- Sling legs that are not being used can easily be removed, thereby increasing safety at the work site.
- The quantity of sling material is greatly reduced, providing cost savings.
- The chain sling can be reconfigured on site, thus increasing efficiency.

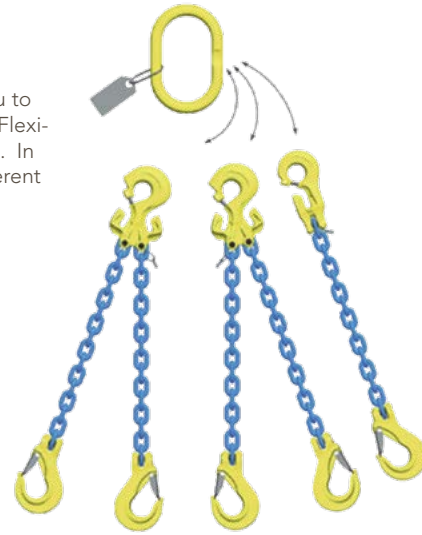

GrabiQ FlexiLeg – a total of 5 legs replaces the total of 10 legs with the old traditional system.

**GrabiQ™**

1 Master Link



## Traditional System



## Related Products

**QuickPin** - For safe exchange of sling legs

- Fits all C-components (CL, CLD, CG, CGD)
- Has instant close/open function, no tools needed!
- Easy to retrofit!
- Made of stainless steel for long product life span.

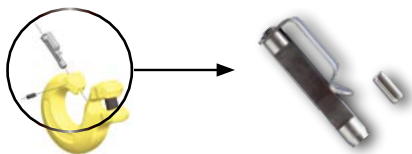

**FlexiTag** - For every GrabiQ sling

- Specially designed for FlexiLeg
- Fits all other GrabiQ slings
- WLL and chain size pre-stamped for 1 - 4 legs
- Leg angle 30/45 degree shown in contour
- Made of stainless steel for use in all weather conditions.

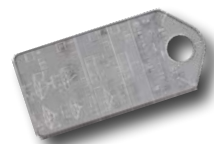

# GrabIQ Solutions for Every Need

## 1-leg Chain Slings



**MG1-GBK**  
Consist of: Master link MG,  
Chain KLA, Safety Hook GBK

Chain size mm	Chain size	WLL lb*	Total Components length (in)
6	-	3 300	6.73
8	5/16"	5 700	11.65
10	3/8"	8 800	14.21
13	1/2"	15 000	17.83
16	5/8"	22 600	20.75



**MG1-EGKN**  
Type: Master link MG, Chain KLA,  
Hook with latch EGKN

Chain size mm	Chain size	WLL lb*	Total Components length (in)
6	-	3 300	9.09
8	5/16"	5 700	10.28
10	3/8"	8 800	13.03
13	1/2"	15 000	16.06
16	5/8"	22 600	18.94



**TG1-GBK**  
Master link MF, C-grab CG,  
Chain KLA, Safety Hook GBK

Chain size mm	Chain size	WLL lb*	Total Components length (in)
6	-	3 300	7.87
8	5/16"	5 700	13.62
10	3/8"	8 800	16.69
13	1/2"	15 000	19.84
16	5/8"	22 600	24.45



**TG1-EGKN**  
Consists of: Master link MF, C-grab CG,  
Chain KLA, Hook with latch EGKN

Chain size mm	Chain size	WLL lb*	Total Components length (in)
6	-	3 300	11.26
8	5/16"	5 700	13.46
10	3/8"	8 800	16.34
13	1/2"	15 000	19.96
16	5/8"	22 600	24.57

## 2-leg Chain Slings



**MGD2-EGKN**  
Consists of: Master link MGD,  
Chain KLA, Latch Hook EGKN

Chain size mm	Chain size	$\beta$ 60°	$\beta$ 45°	$\beta$ 30°	Total Components length (in)
6	-	5 500	4 625	3 300	9.06
8	5/16"	9 900	8 100	5 700	10.28
10	3/8"	15 200	12 400	8 800	13.03
13	1/2"	26 000	21 200	15 000	16.06
16	5/8"	39 100	32 000	22 600	18.94

**MGD2-GBK**  
Consists of: Master link MGD,  
Chain KLA, Safety Hook GBK



Chain size mm	Chain size	WLL lb*			Total Components length (in)
		$\beta$ 60°	$\beta$ 45°	$\beta$ 30°	
6	-	5 500	4 625	3 300	9.25
8	5/16"	9 900	8 100	5 700	11.65
10	3/8"	15 200	12 400	8 800	14.21
13	1/2"	26 000	21 200	15 000	17.83
16	5/8"	39 100	32 000	22 600	20.75

**TG2-GBK**  
Consists of: Master link MF, C-grab Duo CGD,  
Chain KLA, Safety Hook GBK



Chain size mm	Chain size	WLL lb*			Total Components length (in)
		$\beta$ 60°	$\beta$ 45°	$\beta$ 30°	
6	-	5 500	4 625	3 300	11.46
8	5/16"	9 900	8 100	5 700	14.41
10	3/8"	15 200	12 400	8 800	17.48
13	1/2"	26 000	21 200	15 000	21.02
16	5/8"	39 100	32 000	22 600	26.42

**TG2-EGKN**  
Consists of: Master link MF, C-grab Duo CGD,  
Chain KLA, Latch Hook EGKN



Chain size mm	Chain size	WLL lb*			Total Components length (in)
		$\beta$ 60°	$\beta$ 45°	$\beta$ 30°	
6	-	5 500	4 625	3 300	11.26
8	5/16"	9 900	8 100	5 700	13.46
10	3/8"	15 200	12 400	8 800	16.34
13	1/2"	26 000	21 200	15 000	19.96
16	5/8"	39 100	32 000	22 600	24.61

**MGD2-CL**  
Consists of: Master link MGD,  
Chain KLA, C-lok CL



Chain size mm	Chain size	WLL lb*			Total Components length (in)
		$\beta$ 60°	$\beta$ 45°	$\beta$ 30°	
6	-	5 500	4 625	3 300	7.36
8	5/16"	9 900	8 100	5 700	9.06
10	3/8"	15 200	12 400	8 800	11.22
13	1/2"	26 000	21 200	15 000	14.13
16	5/8"	39 100	32 000	22 600	16.89

See 3- and 4-leg GrabIQ solutions on next page

## 3-leg Chain Sling

**TG3-GBK**  
 Consists of: Master link MF,  
 C-grab CG, C-grab Duo CGD,  
 Chain KLA, Safety Hook GBK



Chain size mm	Chain size	WLL lb*			Total component length (in)
		$\beta$ 60°	$\beta$ 45°	$\beta$ 30°	
6	-	8 400	6 800	4 850	12.24
8	5/16"	14 800	12 100	8 500	15.43
10	3/8"	22 900	18 700	13 200	18.66
13	1/2"	39 000	31 800	22 500	23.78
16	5/8"	58 700	47 900	33 900	26.77

**TG3-EGKN**  
 Consists of: Master link MF, C-grab CG,  
 C-grab Duo CGD, Chain KLA,  
 Latch Hook EGKN



Chain size mm	Chain size	WLL lb*			Total Component length (in)
		$\beta$ 60°	$\beta$ 45°	$\beta$ 30°	
6	-	8 400	6 800	4 850	12.05
8	5/16"	14 800	12 100	8 500	14.06
10	3/8"	22 900	18 700	13 200	17.48
13	1/2"	39 000	31 800	22 500	22.01
16	5/8"	58 700	47 900	33 900	24.96

## 4-leg Chain Sling

**TG4-GBK**  
 Consists of: Master link MF, C-grab  
 Duo CGD, Chain KLA, Safety Hook GBK



Chain size mm	Chain size	WLL lb*			Total Component length (in)
		$\beta$ 60°	$\beta$ 45°	$\beta$ 30°	
6	-	8 400	6 800	4 850	12.24
8	5/16"	14 800	12 100	8 500	15.43
10	3/8"	22 900	18 700	13 200	18.66
13	1/2"	39 000	31 800	22 500	23.78
16	5/8"	58 700	47 900	33 900	26.77

**TG4-EGKN**  
 Consists of: Master link MF, C-grab  
 Duo CGD, Chain KLA, Latch Hook EGKN



Chain size mm	Chain size	WLL lb*			Total Component length (in)
		$\beta$ 60°	$\beta$ 45°	$\beta$ 30°	
6	-	8 400	6 800	4 850	12.05
8	5/16"	14 800	12 100	8 500	14.06
10	3/8"	22 900	18 700	13 200	17.48
13	1/2"	39 000	31 800	22 500	22.01
16	5/8"	58 700	47 900	33 900	24.96

## Load Table for Grade 10 Chain Slings

Working Load Limits in pounds for chain slings grade 10, according to NACM

Based on A 906/A 906M-2

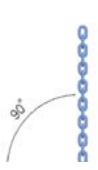
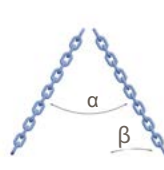
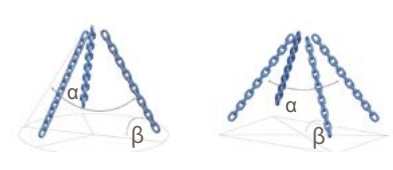
		1-leg	2-leg			3- and 4-leg		
								
			$\beta$ 60°	$\beta$ 45°	$\beta$ 30°	$\beta$ 60°	$\beta$ 45°	$\beta$ 30°
Chain size mm	Chain size inch		$\alpha$ 60°	$\alpha$ 90°	$\alpha$ 120°	$\alpha$ 60°	$\alpha$ 90°	$\alpha$ 120°
6	-	3 300	5 500	4 625	3 300	8 400	6 800	4 850
7	9/32"	4 300	7 400	6 100	4 300	11 200	9 100	6 400
8	5/16"	5 700	9 900	8 100	5 700	14 800	12 100	8 500
10	3/8"	8 800	15 200	12 400	8 800	22 900	18 700	13 200
13	1/2"	15 000	26 000	21 200	15 000	39 000	31 800	22 500
16	5/8"	22 600	39 100	32 000	22 600	58 700	47 900	33 900
20	3/4"	35 300	61 100	49 900	35 300	91 700	74 900	52 950
22	7/8"	42 700	74 000	60 400	42 700	110 900	90 600	64 000
26	1"	59 700	103 100	84 100	59 500	155 600	126 600	89 250
32	1-1/4"	88 160	152 700	124 600	88 160	229 000	186 950	132 200

Safety factor 4:1. Working load limits are based upon equally loaded and disposed sling legs.

# Midgrab Chain Shortener, MIG

## Product Features

- Instant mounting and positioning on any part of the chain.
- Shortening in either chain direction; up-down.
- Designed to prevent inadvertent chain disengagement.
- Can be set idle on the chain leg when shortening is not required.
- LC version offers secure mounting with locking set on any desired part of the chain with one chain direction open for shortening.
- CC version offers close-open function in both chain directions for safe retention of the chain.

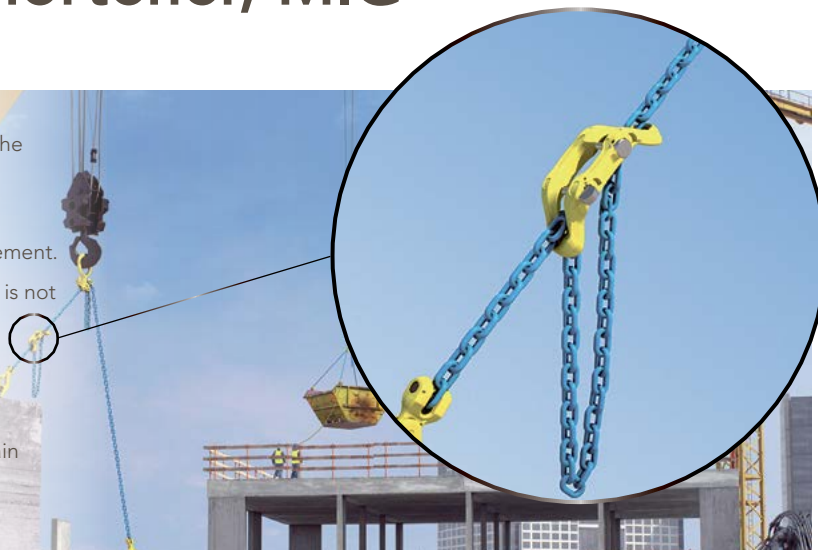

2

## Locking Devices for Midgrab MIG

Note! The MIG should be used with at least one locking devices.

### L - fixed locking set

For fixed mounting

Code:

L-8: B14905

L-10: B14915

L-13: B14917



### C - close/open locking set

Spring operated locking device. Can be placed either in open or closed position.

Code:

C-8: B14904

C-10: B14914

C-13: B14916



## Product Code Guide - Locking options



MIG C



MIG CC



MIG L



MIG LC

### MIG with C pins

Art. no.	Code	WLL lb*	L	X	Y	Weight lb
B14303	MIG CC-8-10	5 700	3.74	1.97	2.36	1.54
B14313	MIG CC-10-10	8 800	4.92	2.76	3.03	2.42
B14323	MIG CC-13-10	15 000	5.91	3.54	3.15	5.73

### MIG without pins

Art. no.	Code	WLL lb*	L	X	Y	Weight lb
B14300	MIG-8-10	5 700	3.74	1.97	2.36	1.32
B14310	MIG-10-10	8 800	4.92	2.76	3.03	2.20
B14320	MIG-13-10	15 000	5.91	3.54	3.15	5.51

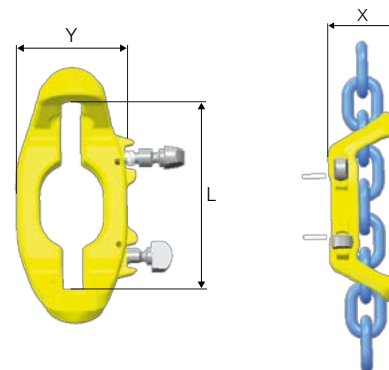

# Identification of our Master Links

To provide good readability and traceability our master links have the following marking:

## Product type

- M - represents single type master link.
- MT - represents master link assembly.
- OS - is an abbreviation for offshore. All Arctic offshore master links are marked with OS and complies with DNV 2.7-1.

## Size designation

- The size is linked to the WLL as well as to compatible products, like attachment links and other components.
- Trade size.
- The size expressed in inch.

## Approved by BG/DGUV

- H32 – represents Gunnebo Industries' manufacturing ID. The ID also represents a 3rd part audit by BG in Germany.

## Traceability code

- The traceability code is unique for the production batch and normally consists of a letter and a number; for example A2. The traceability code makes it possible to trace and track the product through the whole production process back to the raw material used for the actual product.

## Gunnebo Sweden

- To clearly highlight the Gunnebo Industries brand, our master links are marked with *Gunnebo Sweden*.

## Meets the standards

- The markings fulfills the requirements of EN 1677-4, ASTM A952, AS 3775.2 and DNV 2.7-1.



## Master Link M

Art. no.	Code	WLL lb (SF 5:1)		L	E	D	Weight lb
		EN 1677-4	A-952/A952M AS 3775.2-2014				
Z101271	M-6-10	3 306	3 306	3.94	2.36	3/8"	0.44
Z101272	M-86-10	5 510	7 100	4.92	2.76	1/2"	0.88
Z101273	M-108-10	8 800	11 460	5.51	3.15	5/8"	1.76
Z101274	M-13-10	15 000	15 000	5.91	3.54	3/4"	2.20
Z101267	M-1310-10	16 530	17 632	6.30	3.74	7/8"	3.31
Z101268	M-1613-10	22 040	29 974	7.48	4.33	1 1/8"	6.17
Z101247	M-19-10	26 448	35 300	7.87	4.72	1 3/16"	7.72
Z101269	M-2016-10	37 468	45 402	9.45	5.51	1 3/8"	11.46
Z101270	M-2220-10	55 100	68 103	9.84	5.91	1 9/16"	16.09
Z101275	M-2622-10	61 712	70 528	9.84	5.91	1 5/8"	19.18
Z101284	M-32-10	72 732	85 074	11.81	7.09	1 3/4"	25.79
Z101276	M-3226-10	94 772	102 706	11.81	7.87	2"	32.63
Z101277	M-3632-10	123 424	143 260	13.78	7.87	2 1/8"	45.64
Z101278	M-4536-10	154 280	160 231	14.76	8.27	2 3/8"	58.20
Z101279	M-90T-10	198 360	220 400	17.72	9.84	2 3/4"	94.36
Z101280	M-125T-10**	275 500	275 500	17.72	10.24	3 1/8"	125.66

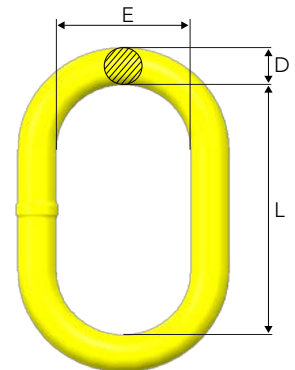

\*\* Dimension L and E not acc. to EN 1677-4.

Fulfills requirements in: EN 1677:2008 (WLL +25%), ASTM A952/A952M, AS 3775:2014 and AS 3776:2015.

## Master Link MF

For 1-, 2-, 3- and 4-leg slings. Designed for use with CL, CLD, CG and CGD. 3- and 4 leg chain slings require CLD / CGD.

Art. no.	Code	WLL lb (SF 5:1)		For chain size			L	E	D	Weight lb
		EN 1677-4	A-952/A952M AS 3775.2-2014	1-leg	2-leg	3-4-leg				
B14487	MF-6-10	3 306	3 306	(6mm)			3.94	2.36	3/8"	0.44
B14481	MF-86-10	5 510	7 100	5/16"	(6mm)	-	4.92	2.76	1/2"	0.88
B14482	MF-108-10	8 800	11 460	3/8"	5/16"	(6mm)	5.51	3.15	5/8"	1.76
B14483	MF-1310-10	16 530	17 632	1/2"	3/8"	5/16"	6.30	3.74	7/8"	3.31
B14484	MF-1613-10	22 040	29 974	5/8"	1/2"	3/8"	7.48	4.33	1 1/8"	6.17
B14485	MF-2016-10	37 468	45 402	3/4"	5/8"	1/2"	9.45	5.51	1 3/8"	11.46
B14486	MF-2220-10	55 100	68 103	7/8"	3/4"	5/8"	9.84	5.91	1 9/16"	16.09

Fulfills requirements in: EN 1677:2008 (WLL +25%), ASTM A952/A952M, AS 3775:2014 and AS 3776:2015.

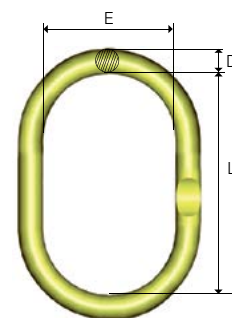

## Master Link MFH

Designed for crane hooks, DIN 15401 and 15402. Designed for use with CL, CLD, CG and CGD. 3- and 4 leg chain slings require CLD / CGD.

Art. no.	Code	WLL lb (SF 5:1)		For chain size			L	E	D	DIN 15401	DIN 15402	Weight lb
		EN 1677-4	A-952/A952M AS 3775.2-2014	1-leg	2-leg	3-4 leg						
Z101262	MFH-1310-10	16 530	17 632	1/2"	3/8"	5/16"	9.06	4.92	7/8"	≤ 12	≤ 16	4.19
Z101263	MFH-1613-10	22 040	29 974	5/8"	1/2"	3/8"	9.84	5.31	1 1/8"	≤ 12	≤ 16	7.05
Z101264	MFH-2016-10	37 468	45 402	3/4"	5/8"	1/2"	11.02	5.31	1 1/4"	≤ 16	≤ 20	10.14
Z101265	MFH-2220-10	61 712	68 104	7/8"	3/4"	5/8"	12.60	6.89	1 9/16"	≤ 25	≤ 32	18.96
Z101266	MFHW-2220-10	55 617	61 712	7/8"	3/4"	5/8"	13.98	8.86	1 9/16"	≤ 50	≤ 63	21.83

Fulfills requirements in: EN 1677:2008 (WLL +25%), ASTM A952/A952M, AS 3775:2014 and AS 3776:2015.

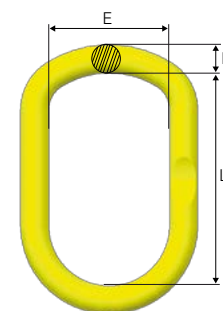

## Master Link with Sublinks, MT

Designed for use with chain or wire rope. For 3- and 4-leg slings

Art, no,	Code	WLL lb (SF 5:1)		L1	L	E	D	l	e	d	Weight lb
		EN 1677-4	A-952/A952M AS 3775.2-2014								
Z100902	MT-6-10	7 714	11 020	10.63	5.91	3.54	3/4"	4.72	2.76	1/2"	3.97
Z100903	MT-8-10	11 461	17 632	11.81	6.30	3.74	7/8"	5.51	3.15	5/8"	6.61
Z101359	MT-9-10	15 208	21 379	13.39	7.48	4.33	1 1/8"	5.91	3.54	3/4"	10.80
Z100904	MT-10-10	25 346	35 300	14.17	7.87	4.72	1 3/16"	6.30	3.74	7/8"	14.11
Z100905	MT-13-10	37 468	57 304	17.32	9.84	5.91	1 9/16"	7.48	4.33	1 1/8"	31.31
Z100906	MT-16-10	61 712	77 140	19.69	11.81	7.87	2"	7.87	4.72	1 1/4"	50.71
Z101074	MT-20-10	77 140	110 200	21.65	11.81	7.87	2 1/8"	9.84	5.91	1 9/16"	69.45
Z101281	MT-22-10	116 812	165 300	24.02	13.78	7.87	2 3/8"	10.24	5.51	1 3/4"	101.41
Z101282	MT-26-10	154 280	220 400	28.74	17.72	9.84	2 3/4"	11.02	6.30	2	156.53
Z101283	MT-32-10	198 360	275 500	28.74	17.72	10.24	3 1/8"	11.02	6.30	2 1/8"	200.62

Fulfills requirements in: EN 1677:2008 (WLL +25%), ASTM A952/A952M, AS 3775:2014 and AS 3776:2015.

Flattened section on the sublinks for sizes up to MT-20-10 except MT-9-10.

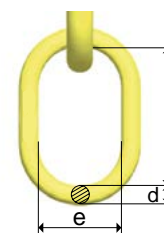
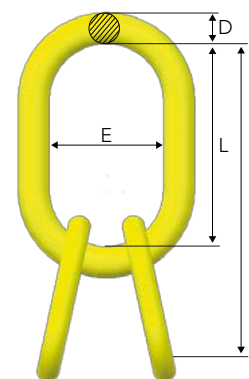

## Master Link, MFX

Oversized, for 1- and 2-leg slings. Designed for use with CL, CLD, CG and CGD.

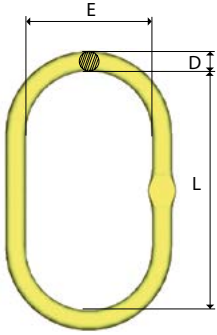

Art. no.	Code	WLL lb (SF 5:1)		For chain 1-leg	For chain 2-leg	L	E	D	Weight lb
		EN 1677-4	A-952/A952M AS 3775.2-2014						
Z100550	MFX-108-10	9 367	11 461	5/16", 3/8"	5/16"	13.39	7.09	1"	8.16
Z100551	MFX-1310-10	16 530	17 632	1/2"	3/8"	13.39	7.09	1 1/8"	10.36
Z100552	MFX-1613-10	24 685	29 974	5/8"	1/2"	13.39	7.09	1 3/8"	15.65
Z101125	MFX-2016-10	35 300	45 402	3/4"	5/8"	13.39	7.09	1 9/16"	21.16

Fulfills requirements in: EN 1677:2008 (WLL +25%), ASTM A952/A952M, AS 3775:2014 and AS 3776:2015.

## Master Grab MG

"All-in-one" compact top link.

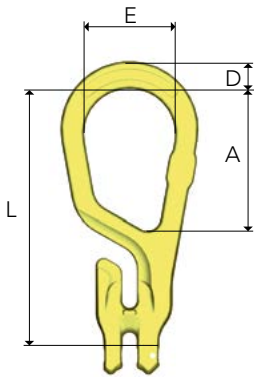

Art. no.	Code	WLL lb*	L	A	E	D	Weight lb
B14710	MG-6-10	3 306	5.71	3.46	2.36	0.59	1.10
B14711	MG-8-10	5 700	6.73	3.62	2.36	0.71	1.98
B14712	MG-10-10	8 800	8.31	4.45	2.95	0.87	3.97
B14713	MG-13-10	15 000	10.28	5.43	3.54	1.02	7.72
B14714	MG-16-10	22 600	12.24	6.18	4.13	1.22	13.45

Fulfills requirements in: EN 1677:2008 (WLL +25%), ASTM A952/A952M and AS 3776:2015.

## Master Grab Duo MGD

"All-in-one" compact top link for 2-leg slings.

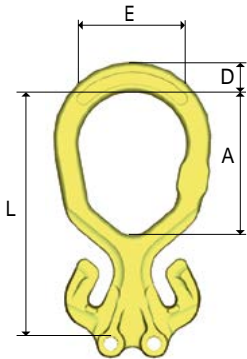

Art. no.	Code	WLL lb*	L	A	E	D	Weight lb
B14700	MGD-6-10	4 700	5.7	3.5	2.4	0.67	1.5
B14701U	MGD-8-10	9 900	6.7	3.9	3.0	0.83	2.9
B14702U	MGD-10-10	15 200	8.3	4.9	3.5	0.94	5.1
B14703U	MGD-13-10	26 000	10.3	5.9	4.1	1.2	11.5
B14704U	MGD-16-10	39 100	12.2	6.9	4.7	1.4	17.4

Fulfills requirements in: EN 1677:2008 (WLL +25%), ASTM A952/A952M and AS 3776:2015.

Note! The maximum in service temperature is 392°F.

## Coupling Link G

For use with master link and eyehook.

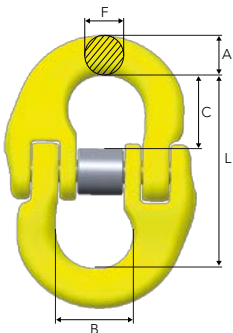

Art. no.	Code	WLL lb*	L	B	F	A	C	Weight lb
Z100821	G-6-10	3 306	1.77	0.59	0.28	0.31	0.63	0.22
Z101358	G-7-10	4 500	2.20	0.71	0.35	0.43	0.87	0.44
Z100822	G-8-10	5 700	2.20	0.71	0.35	0.43	0.87	0.44
Z100823	G-10-10	8 800	2.68	0.98	0.47	0.51	1.02	0.66
Z100824	G-13-10	15 000	3.50	1.14	0.59	0.67	1.30	1.54
Z100825	G-16-10	22 600	4.17	1.42	0.75	0.79	1.57	3.09
Z101119	G-20-10	35 300	4.92	1.69	0.91	1.02	1.73	4.85
Z101339	G-22-10	44 080	5.98	1.97	1.02	1.10	2.32	7.72
Z101365	G-26-10	60 169	6.34	2.28	1.26	1.34	2.40	12.57
Z101666	G-32-10	88 160	7.87	2.76	1.50	1.57	3.03	20.94

Fulfills requirements in: EN 1677:2008 (WLL +25%), ASTM A952/A952M and AS 3776:2015.



## C-Grab CG

For use with master link, eyehooks and choke.

Art. no.	Code	WLL lb*	L	B	E	D	Weight lb
B14730	CG-6-10	3 306	3.15	0.43	0.94	0.75	0.66
B14731	CG-8-10	5 700	4.21	0.47	1.26	0.94	1.54
B14732	CG-10-10	8 800	5.28	0.59	1.57	1.14	3.31
B14733	CG-13-10	15 000	6.77	0.71	2.05	1.50	7.05
B14734	CG-16-10	22 600	8.46	0.87	2.52	1.85	13.45

Fulfills requirements in: EN 1677:2008 (WLL +25%), ASTM A952/A952M and AS 3776:2015.

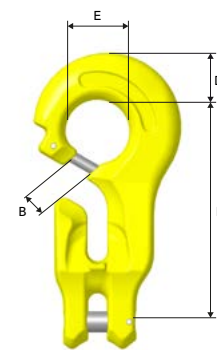

2

## C-Grab Duo CGD

For use with master links.

Art. no.	Code	WLL lb*	L	B	E	D	Weight lb
B14720	CGD-6-10	4 700	3.1	0.43	0.94	0.87	1.1
B14721U	CGD-8-10	9 900	4.2	0.47	1.3	1.1	2.4
B14722U	CGD-10-10	15 200	5.3	0.59	1.6	1.5	4.8
B14723U	CGD-13-10	26 000	6.8	0.75	1.9	1.9	11.9
B14724U	CGD-16-10	39 100	8.5	0.87	2.5	2.2	20.1

Fulfills requirements in: EN 1677:2008 (WLL +25%), ASTM A952/A952M and AS 3776:2015.

Note! The maximum in service temperature is 392°F.

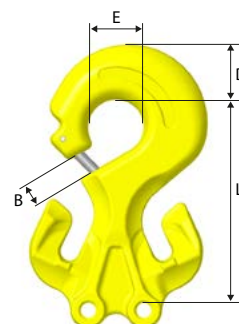

## C-Lok CL

For use with master links, eyehooks and choke.

Art. no.	Code	WLL lb*	L	B	E	D	Weight lb
B14750	CL-6-10	3 306	1.69	0.43	0.94	0.71	0.44
B14751	CL-8-10	5 700	2.28	0.47	1.26	0.94	1.10
B14752	CL-10-10	8 800	2.91	0.59	1.57	1.14	2.20
B14753	CL-13-10	15 000	3.70	0.71	2.05	1.50	4.41
B14754	CL-16-10	22 600	4.69	0.87	2.52	1.89	8.38

Fulfills requirements in: EN 1677:2008 (WLL +25%), ASTM A952/A952M and AS 3776:2015.

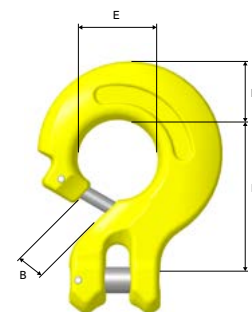

## C-Lok Duo CLD

For use with master links.

Art. no.	Code	WLL lb*	L	B	E	D	Weight lb
B14740	CLD-6-10	5 700	1.69	0.43	0.94	0.87	0.88
B14741U	CLD-8-10	9 918	2.28	0.47	1.26	1.14	1.32
B14742U	CLD-10-10	15 317	2.91	0.59	1.57	1.46	2.65
B14743U	CLD-13-10	26 007	3.70	0.71	2.05	1.81	6.83
B14744U	CLD-16-10	39 231	4.69	0.98	2.52	2.24	12.13

Fulfills requirements in: EN 1677:2008 (WLL +25%), ASTM A952/A952M and AS 3776:2015.

Note! The maximum in service temperature is 392°F.

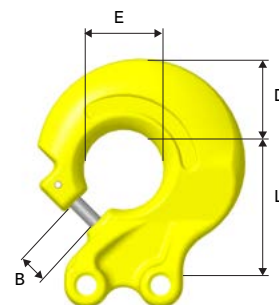

## Chain, GrabiQ Grade 10 (200)

Short link, KL

**Heat treatment**

Hardened and tempered.

Note! For chain grade 10 (200) the maximum in service temperature is 392°F.

**Surface finish**

Painted blue

**Fulfills the requirements in:**

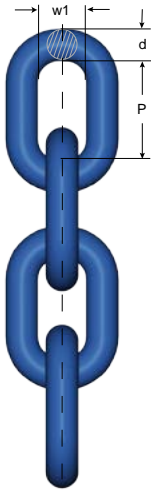
 ASTM A973/A973M-07(2012)  
 EN 818-2:2008 (WLL +25%,  
 reduced temperature range)

Art. no. Box	Code	WLL lb	d nom.	P	w1	Weight lb/foot	MPF kN	Breaking force lb
Z802300 - 1 x 656 ft	KLA 6-10 (200)	3 306	(6mm)	0.71	0.33	0.54	8 272	13 240
Z802337 - 1 x 656 ft	KLA 7-10 (200)	4 300	9/32"	0.83	0.39	0.74	10 790	17 309
Z802301 - 1 x 656 ft	KLA 8-10 (200)	5 700	5/16"	0.94	0.43	0.94	14 162	22 929
Z802302 - 1 x 328 ft	KLA 10-10 (200)	8 800	3/8"	1.18	0.55	1.55	22 030	35 518
Z802303 - 1 x 328 ft	KLA 13-10 (200)	15 000	1/2"	1.54	0.70	2.55	37 316	60 246
Z802304 - 1 x 328 ft	KLA 16-10 (200)	22 600	5/8"	1.89	0.86	3.77	56 424	90 369
Z802305 - 1 x 164 ft	KLA 20-10 (200)	35 300	3/4"	2.36	1.06	6.32	88 346	141 624
Z802246 - 1 x 164 ft	KLA 22-10 (200)	44 080	7/8"	2.60	1.14	7.93	110 376	176 468
Z802248 - 1 x 164 ft	KLA 26-10 (200)	59 500	1"	3.07	1.38	9.81	149 267	238 737
Z802440 - 1 x 82 ft	KLA 32-10 (200)	88 160	1 1/4"	3.78	1.64	16.40	220 528	361 928

## Chain, GrabiQ Grade 10 (400)

Short link, KL

**Heat treatment**

Hardened and tempered.

Note! For chain grade 10 (400) the maximum in service temperature is 752°F.

**Surface finish**

Painted blue

**Fulfills the requirements in:**

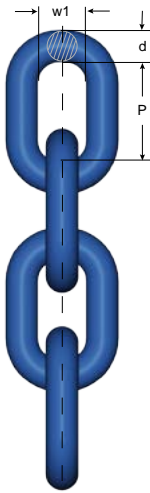
 EN 818-2:2008 (WLL+25%,  
 material dimension Ø +10%)

Note: This chain is marked with "8+" in addition to the marking required by the machine directive

Art. no. Box	Code	WLL lb	d nom.	P	w1	Weight lb/foot	MPF kN	Breaking force lb
Z802306 - 1 x 656 ft	KLA 6-10 (400)	3 306	(6mm)	0.71	0.35	0.67	8 272	13 218
Z802307 - 1 x 656 ft	KLA 8-10 (400)	5 500	5/16"	0.94	0.44	1.14	14 162	22 929
Z802308 - 1 x 328 ft	KLA 10-10 (400)	8 800	3/8"	1.18	0.57	1.75	22 030	35 518
Z802309 - 1 x 328 ft	KLA 13-10 (400)	14 800	1/2"	1.54	0.76	3.02	37 316	60 246
Z802310 - 1 x 328 ft	KLA 16-10 (400)	22 040	5/8"	1.89	0.91	4.50	56 424	90 369

For larger sizes, see GrabiQ Grade 10 (200) or Classic Grade 8.

## Marking and Traceability of Gunnebo Industries Chain

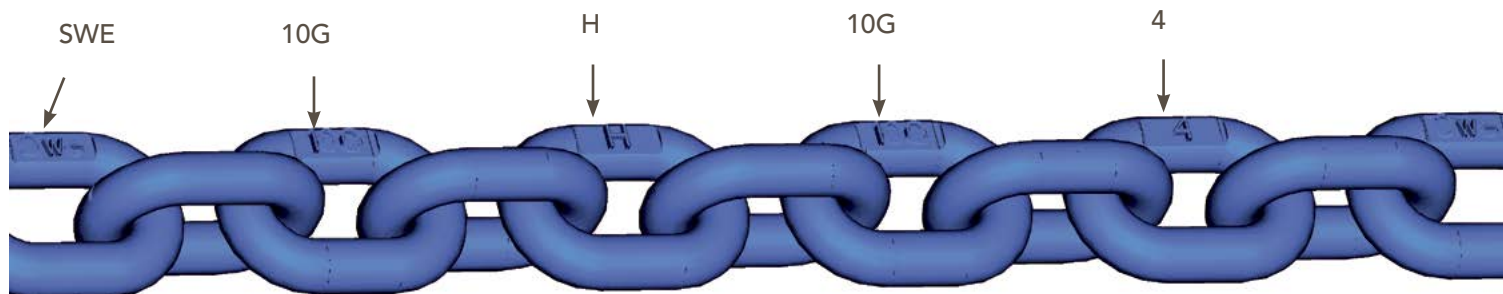

## Grab Hook GG

Clevis shortening hook. No reduction of working load limit, thanks to supporting cradle lugs on either side of hook to prevent chain link deformation.

Art. no.	Code	WLL lb*	L	B	Weight lb
Z101844	GG-6-10	3 306	2.13	0.31	0.44
Z100845	GG-7-10	4 500	2.24	0.39	0.66
B14771	GG-8-10	5 700	2.24	0.39	0.88
B14772	GG-10-10	8 800	2.99	0.47	1.98
B14773	GG-13-10	15 000	3.82	0.63	3.97
B14774	GG-16-10	22 600	4.49	0.79	6.83
Z101152	GG-20-10	35 300	5.79	1.02	15.43

Fulfills requirements in: EN 1677:2008 (WLL +25%), ASTM A952/A952M and AS 3776:2015.

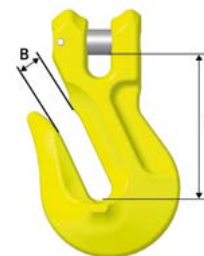

2

## Grab Hook GG with Locking Pin

Clevis shortening hook with locking pin for extra safety. No reduction of working load limit, thanks to supporting cradle lugs on either side of hook to prevent chain link deformation.

Art. no.	Code	WLL lb*	L	B	Weight lb
B14971	GG-8-10 LP	5 700	2.24	0.39	0.88
B14972	GG-10-10 LP	8 800	3.03	0.47	1.98
B14973	GG-13-10 LP	15 000	3.82	0.63	4.19
B14974	GG-16-10 LP	22 600	4.49	0.79	7.05

Fulfills requirements in: EN 1677:2008 (WLL +25%), ASTM A952/A952M and AS 3776:2015.

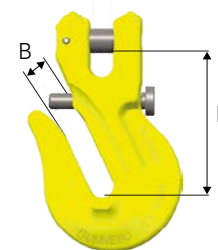

## Grab Hook OG

Eye shortening hook. No reduction of working load limit, thanks to supporting lugs on either side of hook to prevent chain link deformation.

Art. no.	Code	WLL lb*	L	B	E	F	Weight lb
Z101296	OG-7/8-10	5 700	2.56	0.39	0.67	0.39	0.66
Z101297	OG-10-10	8 800	3.35	0.47	0.79	0.47	1.54
Z101298	OG-13-10	15 000	4.09	0.63	1.02	0.63	3.53
Z101299	OG-16-10	22 600	5.16	0.79	1.26	0.75	6.17
Z101300	OG-20-10	35 300	6.57	1.02	1.61	0.91	13.45
Z101301	OG-22-10	44 094	7.36	1.02	1.81	1.26	18.96
Z101302	OG-26-10	60 169	8.98	1.26	2.17	1.50	30.86
Z101303	OG-32-10	88 160	9.02	1.57	1.97	1.06	45.64

Fulfills requirements in: EN 1677:2008 (WLL +25%), ASTM A952/A952M and AS 3776:2015.

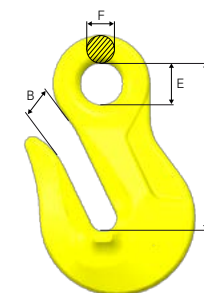

## Safety Hook GBK

Safety hook with clevis connector and grab latch.

Art. no.	Code	WLL lb*	L	B	G	H	Weight lb
Z100758	GBK-6-10	3 306	3.43	1.02	0.59	0.67	0.88
Z100849	GBK-7-10	4 500	4.49	1.42	0.79	0.87	1.10
Z100759	GBK-8-10	5 700	4.69	1.42	0.79	0.87	1.76
Z100760	GBK-10-10	8 800	5.91	1.85	0.87	1.14	3.09
Z100761	GBK-13-10	15 000	6.77	2.09	1.14	1.50	5.95
Z100762	GBK-16-10	22 600	8.19	2.68	1.18	1.77	9.70

Fulfills requirements in: EN 1677:2008 (WLL +25%), ASTM A952/A952M and AS 3776:2015.

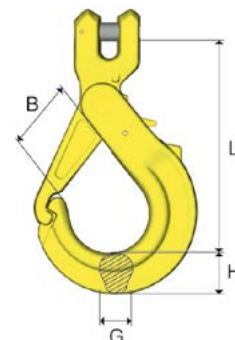

## Safety Hook BKG

Safety hook with clevis connector and standard latch.

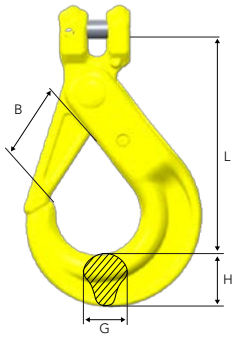

Art. no.	Code	WLL lb*	L	B	G	H	Weight lb
Z101110	BKG-6-10	3 306	3.58	1.14	0.59	0.83	1.10
Z101098	BKG-7-10	4 500	4.72	1.46	0.67	0.87	1.10
Z101100	BKG-8-10	5 700	4.76	1.46	0.67	1.02	1.98
Z101026	BKG-10-10	8 800	5.67	1.77	0.83	1.22	3.31
Z101034	BKG-13-10	15 000	7.09	2.17	1.18	1.57	6.61
Z101042	BKG-16-10	22 600	8.62	2.44	1.46	1.97	12.13
Z101091	BKG-20-10	35 300	9.45	2.68	1.73	2.44	21.16

Fulfills requirements in: EN 1677:2008 (WLL +25%), ASTM A952/A952M and AS 3776:2015.

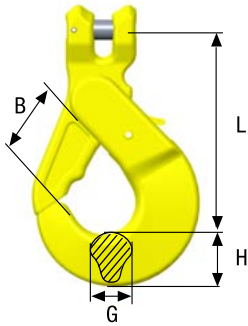

## Safety Hook BKGC

Safety hook with clevis connector for skip loaders.

Art. no.	Code	WLL lb*	L	B	G	H	Weight lb
Z1002401	BKGC-13-10	15 000	6.46	2.17	1.06	1.69	7.05

Fulfills requirements in: EN 1677:2008 (WLL +25%), ASTM A952/A952M and AS 3776:2015.

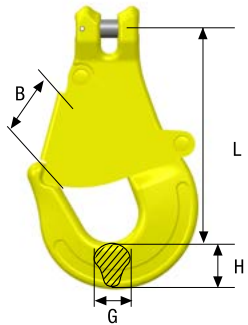

## Sling Hook GKC

Sling hook with clevis connector for skip loaders.

Art. no.	Code	WLL lb*	L	B	G	H	Weight lb
Z7006461	GKC-13-10	15 000	7.40	2.36	1.06	1.69	5.51

Fulfills requirements in: EN 1677:2008 (WLL +25%), ASTM A952/A952M and AS 3776:2015.

## Safety Hook OBK

Safety hook with eye connector and grip latch.

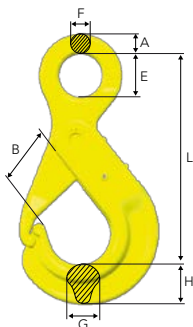

Art. no.	Code	WLL lb*	A	L	B	E	F	G	H	Weight lb
Z101048	OBK-6-10	3 306	0.47	4.06	1.02	0.87	0.35	0.59	0.67	0.88
Z101143	OBK-7/8-10	5 700	0.55	5.47	1.46	1.10	0.39	0.79	0.87	1.76
Z101145	OBK-10-10	8 800	0.63	6.69	1.85	1.34	0.51	0.87	1.14	2.87
Z101147	OBK-13-10	15 000	0.83	8.11	2.09	1.73	0.59	1.14	1.50	5.73
Z101141	OBK-16-10	22 600	1.02	9.88	2.68	2.20	0.75	1.14	1.77	9.70
Z101240	OBK-18/20-10	35 300	1.10	11.54	2.91	2.36	0.87	1.73	2.20	16.09

Fulfills requirements in: EN 1677:2008 (WLL +25%), ASTM A952/A952M and AS 3776:2015.

# BK Safety Hook

## The Original

Gunnebo Industries focus on new product development and innovation to create the optimal solutions for each lifting situation. Since the early 1950's we have developed products that have become today's standards on the market. There is however only one original - Gunnebo Industries. With the original you get the perfect fit and smart details.

Back in 1965 Gunnebo Industries developed the BK hook. The mission was to increase the workplace safety of the construction industry. Today this popular and well known hook is the foundation of the innovative and much appreciated BK product family.



2

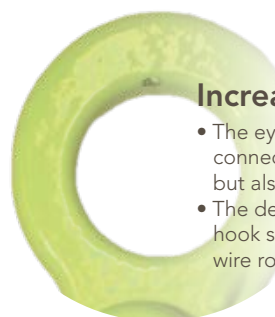

### Increased flexibility

- The eye design enables connection to not only G-links, but also C-links and Berglok.
- The design makes the BK hook suitable for steel wire ropes.

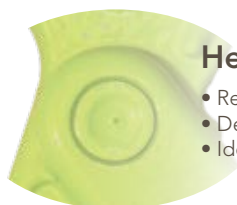

### Heavy duty rivet

- Recessed rivet for a slim design.
- Decreases the risk of snagging.
- Ideal in narrow spaces.

### Clear markings

- Country of origin.
- Traceability codes.
- Model, size and grade.



### Flat section

- For attachment to other GabiQ or wire components.



### Latch rotation stop

- Protects the trigger mechanism from damage.

### Quality is top priority

- Fatigue tested.
- Forged alloy steel.
- Hardened and tempered.
- Every hook is individually proof-loaded at 2,5 x WLL.
- Full traceability back to the raw material.



### Precision manufacturing

- Perfect fit between the parts.
- Increases safety during operation.



### Replaceable trigger set

- Quick and easy assembly.
- Available as a complete spare part kit.

### Recessed trigger

- To avoid the trigger from snagging or being damaged, it has been recessed into the body of the hook.
- Helps to prevent the latch from accidentally opening.

### Fluorescent color

- For high visibility in the field.

## Safety Hook BK

The "original" safety hook with eye connector.

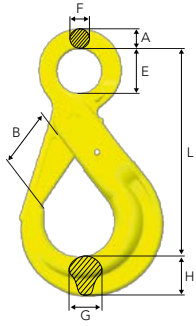

Art. no.	Code	WLL lb*	A	L	B	E	F	G	H	Weight lb
Z101108	BK-6-10	3 306	0.47	4.29	1.14	0.87	0.39	0.59	0.83	1.10
Z101097	BK-7/8-10	5 700	0.55	5.43	1.46	1.10	0.43	0.67	1.02	1.98
Z101024	BK-10-10	8 800	0.63	6.61	1.77	1.34	0.51	0.83	1.22	3.31
Z101032	BK-13-10	15 000	0.79	8.15	2.17	1.73	0.63	1.18	1.57	6.61
Z101040	BK-16-10	22 600	1.02	10.00	2.44	2.20	0.79	1.46	1.97	12.13
Z101089	BK-18/20-10	35 300	1.18	11.38	2.68	2.36	0.87	1.73	2.52	19.84
Z101325	BK-22-10	44 080	1.26	12.60	3.15	2.76	0.94	1.97	2.52	24.91
Z101326	BK-26-10	60 169	1.38	13.46	3.94	3.15	0.98	2.13	2.68	36.38

Fulfills requirements in: EN 1677:2008 (WLL +25%), ASTM A952/A952M and AS 3776:2015.

For larger sizes, see Classic Grade 8.

## Safety Hook BKD

Double latch BK-hook with recessed trigger. Should the first hook latch accidentally open, either through direct impact or excessive wear on the trigger, the extra latch is there to retain the load safely. The secondary latch is designed to be easily operated and will not cause inconvenience for the operator.

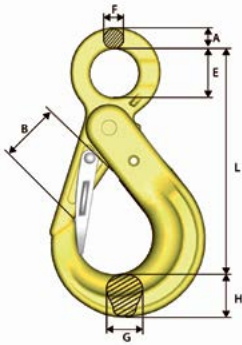

Art. no.	Code	WLL lb*	A	L	B	E	F	G	H	Weight lb
Z101154	BKD-13-10	15 000	0.79	8.15	1.73	1.73	0.63	1.18	1.57	7.05
Z101155	BKD-16-10	22 600	1.02	10.00	1.89	2.20	0.79	1.46	1.97	12.79
Z101156	BKD-18/20-10	35 300	1.18	11.38	2.24	2.36	0.87	1.73	2.44	20.06

Fulfills requirements in: EN 1677:2008 (WLL +25%), ASTM A952/A952M and AS 3776:2015.

## Shank Safety Hook BKT

Safety hook with shank ready for customized machines.

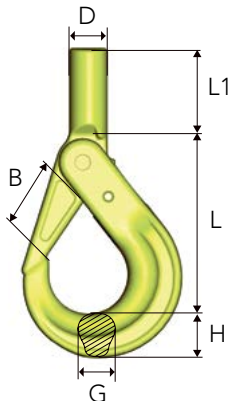

Art. no.	Code	WLL lb*	L	B	L1	D	dmin	G	H	Weight lb
Z1011120	BKT-6-10	3 306	3.54	1.14	1.42	0.79	0.43	0.59	0.83	1.10
Z1011020	BKT-7/8-10	5 700	4.37	1.46	1.85	0.94	0.51	0.67	1.02	1.98
Z1010690	BKT-10-10	8 800	5.24	1.77	2.01	1.14	0.63	0.83	1.22	3.53
Z1010710	BKT-13-10	15 000	6.30	2.17	3.03	1.34	0.79	1.18	1.54	6.61

Fulfills requirements in: EN 1677:2008 (WLL +25%), ASTM A952/A952M and AS 3776:2015.

d min = the smallest permitted shank dimension after machining.

Note! After machining of the shank, proof loading must be carried out.

See machining specifications on page 2:42

## Swivel Safety Hook BKL

Safety hook with swivel for improved positioning of the hook before the load is lifted (360° rotation).

Art. no.	Code	WLL lb*	L	B	C	E	A	G	H	Weight lb
Z101114	BKL-6-10	3 306	5.87	1.14	0.91	1.30	0.43	0.59	0.83	1.54
Z101104	BKL-7/8-10	5 700	7.20	1.46	1.06	1.50	0.47	0.67	1.02	2.65
Z101028	BKL-10-10	8 800	8.58	1.77	1.46	1.73	0.59	0.83	1.22	4.41
Z101036	BKL-13-10	15 000	11.10	2.17	1.93	1.89	0.75	1.18	1.57	8.82
Z101044	BKL-16-10	22 600	13.43	2.44	2.56	2.40	0.98	1.46	1.97	15.87
Z101093	BKL-18/20-10	35 300	14.49	2.68	2.76	2.83	1.22	1.73	2.44	25.13

Fulfills requirements in: EN 1677:2008 (WLL +25%), ASTM A952/A952M and AS 3776:2015.

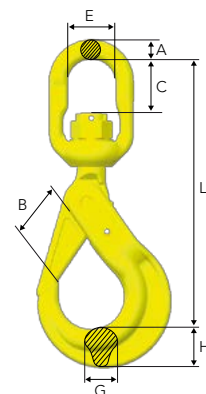

2

## Swivel Safety Hook BKLK

Safety hook with ball-bearing for 360° rotation under full WLL.

Art. no.	Code	WLL lb*	L	B	C	E	A	G	H	Weight lb
Z101116	BKLK-6-10	3 306	5.87	1.14	0.94	1.30	0.43	0.59	0.83	1.54
Z101106	BKLK-7/8-10	5 700	7.20	1.46	1.06	1.50	0.47	0.67	1.02	2.65
Z101030	BKLK-10-10	8 800	8.58	1.77	1.38	1.73	0.59	0.83	1.22	4.41
Z101038	BKLK-13-10	15 000	11.02	2.17	1.77	1.89	0.75	1.18	1.57	8.82
Z101046	BKLK-16-10	22 600	13.35	2.44	2.44	2.40	0.98	1.46	1.97	16.09
Z101095	BKLK-18/20-10	35 300	14.49	2.68	2.36	2.83	1.22	1.73	2.44	25.35
Z101294	BKLK-22-10	44 080	17.17	3.11	3.15	3.15	1.38	1.97	2.44	37.04
Z101295	BKLK-26-10	60 169	19.13	3.94	4.33	4.02	1.77	2.13	2.68	57.32

Fulfills requirements in: EN 1677:2008 (WLL +25%), ASTM A952/A952M and AS 3776:2015.

For larger sizes, see Classic Grade 8.

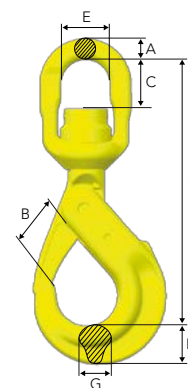

## Swivel Safety Hook with Griplatch LBK

Safety hook with griplatch and swivel for improved positioning of the hook before the load is lifted (360° rotation).

Art. no.	Code	WLL lb*	L	B	C	E	A	G	H	Weight lb
Z100978	LBK-7/8-10	5 700	6.97	1.46	1.06	1.50	0.47	0.79	0.87	2.43
Z100960	LBK-10-10	8 800	8.43	1.85	1.46	1.73	0.59	0.87	1.14	3.97
Z100993	LBK-13-10	15 000	10.31	2.09	1.77	1.89	0.75	1.14	1.50	7.72
Z100995	LBK-16-10	22 600	12.76	2.68	2.60	2.40	0.98	1.18	1.77	13.01

Fulfills requirements in: EN 1677:2008 (WLL +25%), ASTM A952/A952M and AS 3776:2015.

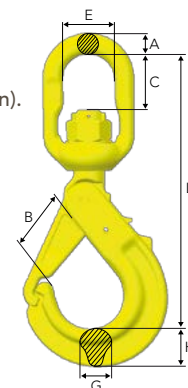

## Swivel Safety Hook with Griplatch LKBK

Safety hook with griplatch and ball-bearing for 360° rotation under full WLL.

Art. no.	Code	WLL lb*	L	B	C	E	A	G	H	Weight lb
Z100980	LKBK-7/8-10	5 700	6.93	1.46	1.06	1.50	0.47	0.79	0.87	2.43
Z100962	LKBK-10-10	8 800	8.39	1.85	1.38	1.73	0.59	0.87	1.14	4.19
Z100997	LKBK-13-10	15 000	10.28	2.09	1.69	1.89	0.75	1.14	1.50	7.94
Z100999	LKBK-16-10	22 600	12.72	2.68	2.40	2.40	0.98	1.18	1.77	13.67

Fulfills requirements in: EN 1677:2008 (WLL +25%), ASTM A952/A952M and AS 3776:2015.

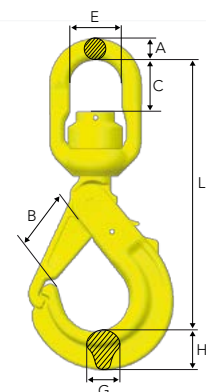

## Sling Hook EGK

Sling hook with clevis connector.

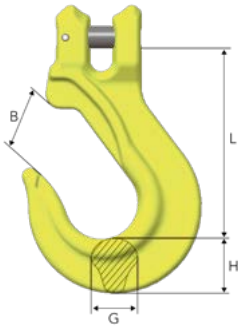

Art. no.	Code	WLL lb*	L	B	G	H	Weight lb
Z100915	EGK-6-10	3 306	3.39	1.14	0.67	0.79	0.88
Z100918	EGK-7-10	4 500	3.74	1.26	0.67	0.87	1.10
Z100938	EGK-8-10	5 700	3.74	1.26	0.67	0.91	1.10
Z100942	EGK-10-10	8 800	4.76	1.61	0.91	1.22	2.20
Z100946	EGK-13-10	15 000	5.71	1.93	1.10	1.50	4.41
Z100950	EGK-16-10	22 600	6.69	2.40	1.42	1.81	8.38
Z101138	EGK-20-10	35 300	8.23	2.80	1.65	2.36	16.09

Fulfills requirements in: EN 1677:2008 (WLL +25%), ASTM A952/A952M and AS 3776:2015.

## Sling Hook EGKN

Sling hook with latch.

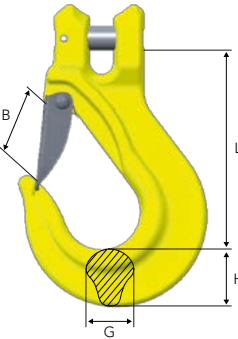

Art. no.	Code	WLL lb*	L	B	G	H	Weight lb
B14460	EGKN-6-10	3 306	3.39	0.98	0.67	0.79	0.88
Z100843	EGKN-7-10	4 500	3.74	1.06	0.67	0.91	1.10
B14461	EGKN-8-10	5 700	3.74	1.10	0.67	0.91	1.10
B14462	EGKN-10-10	8 800	4.76	1.38	0.91	1.22	2.43
B14463	EGKN-13-10	15 000	5.71	1.65	1.10	1.50	4.85
B14464	EGKN-16-10	22 600	6.69	2.09	1.42	1.81	8.82
Z101127	EGKN-20-10	35 300	8.23	2.56	1.65	2.36	16.76

Fulfills requirements in: EN 1677:2008 (WLL +25%), ASTM A952/A952M and AS 3776:2015.

## Sling Hook EK

Sling hook with eye connector.

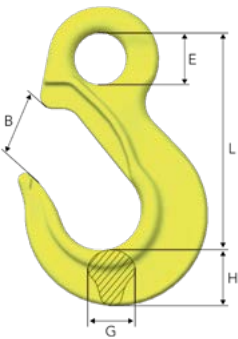

Art. no.	Code	WLL lb*	L	B	E	F	G	H	Weight lb
Z101162	EK- 6-10	3 306	3.66	1.14	0.91	0.39	0.67	0.79	0.88
Z101164	EK- 7/8-10	5 700	4.25	1.26	1.10	0.47	0.67	0.91	1.10
Z101166	EK-10-10	8 800	5.28	1.61	1.34	0.55	0.91	1.18	1.98
Z101168	EK-13-10	15 000	6.54	1.93	1.73	0.71	1.10	1.50	4.41
Z101170	EK-16-10	22 600	7.99	2.40	2.20	0.87	1.42	1.85	7.28
Z101306	EK-20-10	35 300	9.02	2.80	2.40	1.02	1.65	2.36	13.67
Z101307	EK-22-10	44 080	10.51	3.23	2.52	1.22	1.69	2.64	18.74
Z101308	EK-26-10	60 169	11.85	3.74	2.60	1.26	2.01	2.95	26.68
Z101309	EK-32-10	88 160	13.90	4.13	3.54	1.50	2.40	3.86	54.23

Fulfills requirements in: EN 1677:2008 (WLL +25%), ASTM A952/A952M and AS 3776:2015.

## Sling Hook EKN

Sling hook with latch.

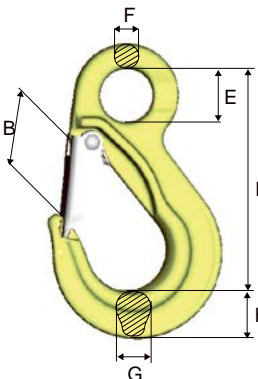

Art. no.	Code	WLL lb*	L	B	E	F	G	H	Weight lb
Z101128	EKN- 6-10	3 306	3.66	0.98	0.91	0.39	0.67	0.79	0.88
Z101130	EKN- 7/8-10	5 700	4.25	1.02	1.10	0.47	0.67	0.91	1.32
Z101132	EKN-10-10	8 800	5.28	1.38	1.34	0.55	0.91	1.18	2.20
Z101134	EKN-13-10	15 000	6.54	1.65	1.73	0.71	1.10	1.50	4.63
Z101136	EKN-16-10	22 600	7.99	2.09	2.20	0.87	1.42	1.85	8.82
Z101327	EKN-20-10	35 300	9.02	2.56	2.40	1.02	1.65	2.36	14.11
Z101328	EKN-22-10	44 080	10.51	2.87	2.52	1.22	1.69	2.64	19.62
Z101329	EKN-26-10	60 169	11.85	3.23	2.60	1.26	2.01	2.95	28.66
Z101330	EKN-32-10	88 160	13.90	3.78	3.54	1.50	2.40	3.86	55.12

Fulfills requirements in: EN 1677:2008 (WLL +25%), ASTM A952/A952M and AS 3776:2015.



## Foundry Hook OKE

Art. no.	Code	WLL lb*	L	B	E	F	G	H	Weight lb
Z100853	OKE-7/8-10	5 700	4.88	2.48	1.10	0.47	0.83	1.02	1.76
Z100854	OKE-10-10	8 800	5.94	2.99	1.34	0.59	1.02	1.18	3.09
Z100855	OKE-13-10	15 000	7.24	3.54	1.73	0.75	1.30	1.54	6.17
Z100898	OKE-16-10	22 600	8.58	4.02	2.20	0.91	1.57	1.81	10.80
Z101340	OKE-20-10	35 300	9.72	4.49	2.36	1.06	1.81	2.36	15.87
Z101341	OKE-22-10	44 080	10.83	4.72	2.52	1.22	2.36	2.76	24.91
Z101342	OKE-26-10	60 169	11.81	4.45	2.76	1.38	2.52	3.03	35.27

Fulfills requirements in: EN 1677:2008 (WLL +25%), ASTM A952/A952M and AS 3776:2015.

For larger sizes, see Classic Grade 8.

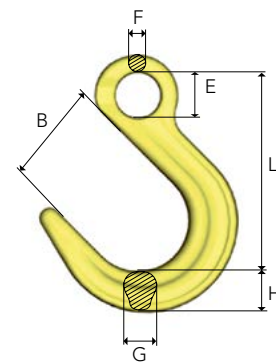

2

## Swivel Latch Hook LKN

Sling hook with swivel for improved positioning of the hook before the load is lifted (360° rotation).

Art. no.	Code	WLL lb*	For chain dim.	L	B	C	E	A	G	H	Weight lb
Z101345	LKN-7/8-10	5 700	9/32", 5/16"	6.10	1.10	1.10	1.50	0.47	0.71	0.94	1.76
Z101346	LKN-10-10	8 800	3/8"	7.56	1.38	1.46	1.73	0.59	0.91	1.22	3.31
Z101347	LKN-13-10	15 000	1/2"	9.37	1.57	1.85	1.89	0.75	1.10	1.50	6.83
Z101348	LKN-16-10	22 600	5/8"	11.61	2.09	2.56	2.40	0.98	1.34	1.69	11.7

Fulfills requirements in: EN 1677:2008 (WLL +25%), ASTM A952/A952M and AS 3776:2015.

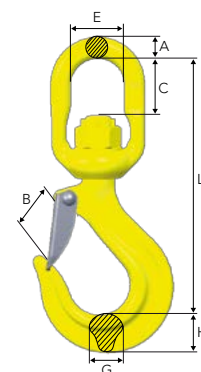

## Swivel Latch Hook LKNK

Swivel latch hook with ball bearing for 360° rotation under full WLL.

Art. no.	Code	WLL lb*	For chain dim	L	B	C	E	A	G	H	Weight lb
Z101349	LKNK-7/8-10	5 700	9/32", 5/16"	6.06	1.10	1.10	1.50	0.47	0.71	0.94	1.98
Z101350	LKNK-10-10	8 800	3/8"	7.52	1.38	1.38	1.73	0.59	0.91	1.22	3.53
Z101351	LKNK-13-10	15 000	1/2"	9.29	1.57	1.77	1.89	0.75	1.10	1.50	7.28
Z101352	LKNK-16-10	22 600	5/8"	11.54	2.09	2.44	2.40	0.98	1.34	1.69	12.3
Z101354	LKNK-22-10	44 080	7/8"	15.75	2.91	3.15	3.15	1.38	1.69	2.64	31.5

Fulfills requirements in: EN 1677:2008 (WLL +25%), ASTM A952/A952M and AS 3776:2015.

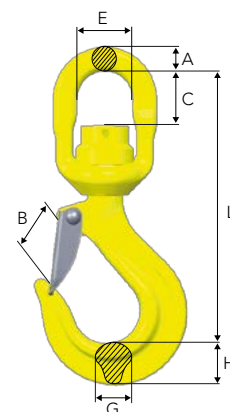

## Clevis Swivel Hook LKNG

For direct connection to small cranes or similar applications that require positioning of hook.

Swivel for improved positioning (360°).

Art. no.	Code	WLL lb*	For chain dim	L	B	C	A	G	H	K	Weight lb
Z101353	LKNG-16-10	22 600	5/8"	10.16	2.09	1.18	1.10	1.34	1.69	1.06	12.5

Fulfills requirements in: EN 1677:2008 (WLL +25%), ASTM A952/A952M and AS 3776:2015.

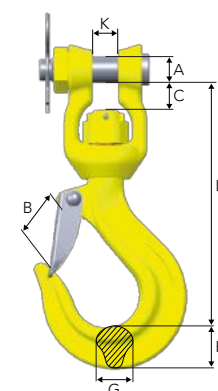



## Roundsling Hook RH

The RH-hook is the perfect load connection solution, combining the advantages of both soft lifting slings and grade 100 components. It can be inserted into a softsling and is quicker and safer to use than the commonly used shackle. The RH-hook is a connector as well as a hook, which gives the user increased flexibility, safer use and increased durability of the soft slings.

The RH-hook comes with a blocking pin, but thanks to the narrow opening it may be used without blocking pin.

Tested according to EN 1677-2

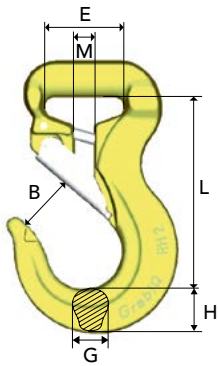

Art. no.	Code	WLL lb*	B	E	G	L	H	M	Weight lb
B14490	RH-1-10	2 204	0.94	1.38	0.65	3.31	0.75	0.31	1.102
B14491	RH-2-10	4 500	1.10	1.57	0.67	3.78	0.87	0.39	1.543
B14492	RH-3-10	6 612	1.30	1.85	0.94	4.61	1.18	0.47	2.866
B14493	RH-5-10	11 020	1.69	2.87	1.06	6.10	1.42	0.65	7.055



The roundsling hooks are color coded: Red=5T / Yellow=3T / Green=2T / Violet=1T

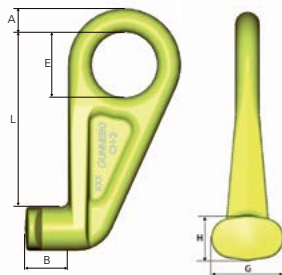

## Container Hook CH

Made for lifting containers in their lower fittings.

Art. no.	Code	WLL lb*	A	L	E	B	H	G	Weight lb
Z101220	CH-3	27 550	0.98	7.36	2.76	1.81	1.85	2.95	8.378
Z101221	CH-3. 45° left	27 550	0.98	7.36	2.76	1.81	1.85	2.95	8.378
Z101219	CH-3. 45° right	27 550	0.98	7.36	2.76	1.81	1.85	2.95	8.378

Alt. 1 - Straight lift

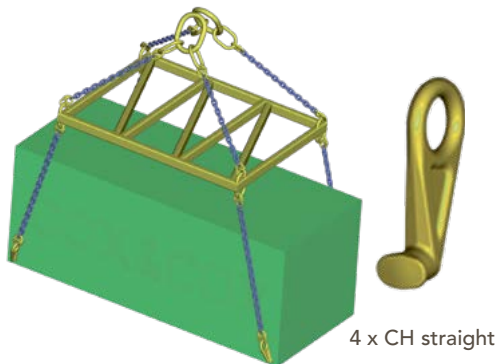

Alt. 2 - Angular lift

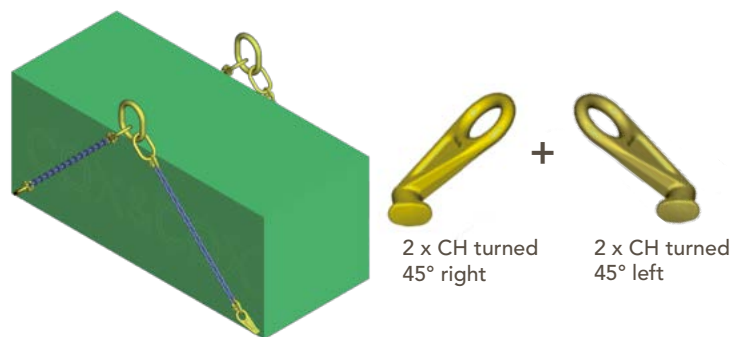

# Chain Tensioner GT - for lifting

One of the main benefits of using chain slings over other types of slings is the ability to shorten the chain to balance the load in asymmetrical lifts. Gunnebo Industries offers a wide range of fittings for shortening, but most of these options only shorten in increments of one chain link. Certain applications require more precision when shortening and for those the GT chain tensioner, approved for lifting purposes, is an excellent choice.

The chain tensioner from Gunnebo Industries, GT, is integral in one set. It is made of high strength Grade 10 material and the ratchet handle contributes to fast and ergonomic shortening. Our chain tensioner is designed to be compatible with the GrabiQ product range, enabling a wide range of fittings to be used for any type of application.



## High precision

The GT tensioner offers stepless adjustment, allowing for precise positioning of the load.



Midgrab Shortener MIG



## 7.8 inches of precision shortening

The GT-tensioner offer 7.8 inches of precision shortening. For shortening of longer increments, our unique Midgrab shortener is the ideal choice.

## Full capacity

As with all Gunnebo Industries' shorteners, there is no reduction in the capacity of the system when shortening.

## 100% proof loaded

Every unit is individually proof loaded to 2.5 x WLL.

## Chain Tensioner GT - for lifting

Art. no	Model	WLL lb*	L = Min. length	L = Max. length	Weight (lb)
Z101367	GT-8-10	5 700	15.75	23.62	7.275
Z101368	GT-10-10	8 800	15.75	23.62	7.275

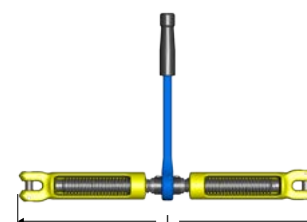

# Offshore Components



**GUNNEBO**  
Industries

# Arctic Offshore

## Innovation and Quality With a Purpose

We have developed products to meet the stringent requirements of the offshore oil & gas industry for many years. The working conditions are tough and products have to be able to sustain extreme conditions. Our double latch hook, BKD, was developed with the aerospace industry as a role model; utilizing redundant systems. The extra latch on the BKD is designed to retain the load in case an unintended opening of the first latch should occur.

Our lifting systems have been valued for their long durability and quality. Regardless of the environmental conditions, our systems have provided lifting operations with high safety. Our quality systems give us the tools to work with continuous improvements and we will always put our great efforts into our mission to create the best

available in the market. Our quality is there with a purpose.

### DNV 2.7-1 certificate

We are type-approved by DNV to manufacture master links and shackles in accordance with DNV 2.7.1 specification. The approval verifies that Gunnebo Industries has a high consistent level of production stability in the entire process, from raw material to the finished product.



-40°C



# Arctic Offshore Master Links

- Type Approved to DNV 2.7-1

Adverse weather and rough sea conditions - sometimes in combination with extremely low temperatures - must be included in the design and safety factor of container lifting sets. The heat treatment of the components must ensure proper ductility and strength to sustain shock loads which may be imposed when the container is lifted from the deck of a vessel.

The lifting sets and its included components must be specially designed for the purpose to lift offshore containers. One of the main differences compared to the onshore standard or specification, is that it allows for the dynamic forces at sea by adding an extra enhancement factor to increase the level of safety. Another difference is that the requirements and testing of materials that will be used in cold environments, are more extensive.

## Arctic Offshore Master Link M

DNV 2.7-1 and DNV 2.7-3 Type Approved.

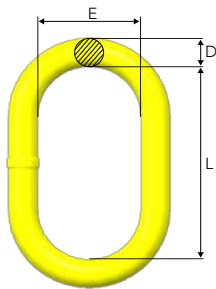

Art. no.	Code	Working Load Limits				L	E	D	Weight lb
		DNV 2.7-1		EN1677-4	A-952/A952M				
		lb	Max. Container rating* lb	SF 5:1 lb	SF 5:1 lb				
Z101486	M-9T- OS	20 497	9 918	20 497	20 497	10.63	5.51	1"	7
Z101487	M-12T- OS	27 550	16 530	27 550	27 550	10.63	5.51	1 1/8"	8
Z101488	M-18T- OS	40 774	29 754	40 774	40 774	10.63	5.51	1 1/4"	11
Z101489	M-24T- OS	52 896	46 284	52 896	52 896	10.63	5.51	1 3/8"	14
Z101490	M-30T- OS	67 222	55 100	67 222	67 222	10.63	5.51	1 9/16"	18
Z101491	M-40T- OS	88 160	N/A	88 160	88 160	11.81	7.09	1 3/4"	26
Z101492	M-50T- OS	110 200	N/A	110 200	110 200	11.81	7.87	2"	34
Z101493	M-65T- OS	143 260	N/A	143 260	143 260	13.78	7.87	2 1/8"	46
Z101494	M-90T- OS	198 360	N/A	198 360	198 360	17.72	9.84	2 3/4"	94
Z101495	M-125T- OS	275 500	N/A	275 500	275 500	17.72	10.24	3 1/8"	127

\* For further information, see DNV 2.7-1

## Arctic Offshore Master Link MT

DNV 2.7-1 and DNV 2.7-3 Type Approved.

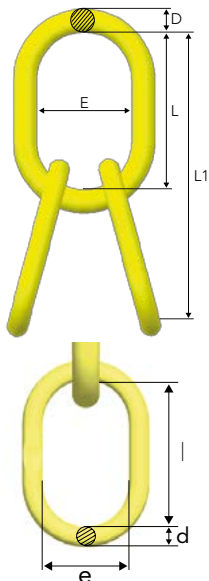

Art. no.	Code	Working Load Limits				L1	L	E	D	I	e	d	Weight lb
		DNV 2.7-1		EN 1677-4	A-952/A952M								
		lb	Max. container rating* lb	SF 5:1 lb	SF 5:1 lb								
Z101586	MT-9T- OS	20 497	9 918	20 497	20 497	16.93	10.63	5.51	1"	6.30	3.74	7/8"	13
Z101587	MT-12T- OS	27 550	16 530	27 550	27 550	16.93	10.63	5.51	1 1/8"	6.30	3.74	1"	17
Z101588	MT-18T- OS	40 774	29 754	40 774	40 774	18.11	10.63	5.51	1 1/4"	7.48	4.33	1 1/8"	24
Z101589	MT-24T- OS	52 896	46 284	52 896	52 896	21.26	10.63	5.51	1 3/8"	10.63	5.51	1 1/4"	37
Z101590	MT-30T- OS	67 222	55 100	67 222	67 222	21.26	10.63	5.51	1 9/16"	10.63	5.51	1 3/8"	47
Z101591	MT-40T- OS	88 160	N/A	88 160	88 160	22.44	11.81	7.09	1 3/4"	10.63	5.51	1 9/16"	62
Z101592	MT-50T- OS	110 200	N/A	110 200	110 200	23.62	11.81	7.87	2"	11.81	7.09	1 3/4"	86
Z101593	MT-65T- OS	143 260	N/A	143 260	143 260	25.59	13.78	7.87	2 1/8"	11.81	7.87	2"	113

\* For further information, see DNV 2.7-1

All sublinks have a WLL of min. 75% of the top link.

# Master Link Selection Chart

Reference: DNV 2.7-1 June 2013, Table 8.1

Container rating (lb)	Enhancement factor	Min. required WLL (lb)	Recommended Master link M	Recommended Master link MT
1 102	-	15 428		
2 204	-	15 428		
3 306	-	15 428		
4 408	3.500	15 428		
5 510	2.880	15 869	M-9T OS	MT-9T OS
6 612	2.600	17 192		
7 714	2.403	18 536		
8 816	2.207	19 462		
9 918	2.067	20 498		
11 020	1.960	21 600		
12 122	1.873	22 702		
13 224	1.766	23 363	M-12T OS	MT-12T OS
14 326	1.733	24 818		
15 428	1.700	26 228		
16 530	1.666	27 550		
17 632	1.633	28 807		
18 734	1.600	29 975		
19 836	1.567	31 077		
20 938	1.534	32 113		
22 040	1.501	33 083		
23 142	1.479	34 229	M-18T OS	MT-18T OS
24 244	1.457	35 309		
25 346	1.435	36 366		
26 448	1.413	37 358		
27 550	1.391	38 306		
28 652	1.368	39 210		
29 754	1.346	40 069		
30 856	1.324	40 863		
31 958	1.302	41 612		
33 060	1.280	42 317		
34 162	1.267	43 287		
35 264	1.254	44 213		
36 366	1.240	45 116		
37 468	1.227	45 976		
38 570	1.214	46 813	M-24T OS	MT-24T OS
39 672	1.201	47 629		
40 774	1.188	48 422		
41 876	1.174	49 172		
42 978	1.161	49 899		
44 080	1.148	50 604		
45 182	1.143	51 662		
46 284	1.139	52 720		
47 386	1.135	53 756		
48 488	1.130	54 792		
49 590	1.126	55 828		
50 692	1.121	56 842	M-30T OS	MT-30T OS
51 794	1.117	57 855		
52 896	1.112	58 847		
53 998	1.108	59 839		
55 100	1.104	60 809		



2

## Swivel Safety Hook BKLK Offshore

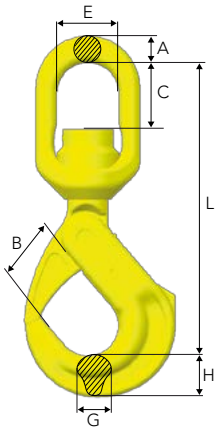

Art. no.	Code	WLL lb 4:1	WLL lb 5:1	L	B	C	E	A	G	H	Weight lb
ZG101370	BKLK-13-8 OS W HDG	14 767	12 000	12.09	2.17	2.83	2.40	0.98	1.18	1.57	10.80
ZG101371	BKLK-16-8 OS W HDG	22 600	18 000	14.45	2.44	3.46	3.23	1.02	1.46	1.97	18.52
ZG1013561	BKLK-18/20-8 OS W HDG	35 300	28 300	15.55	2.68	3.46	3.15	1.38	1.81	2.52	30.64
ZG101294	BKLK-22-8 OS HDG	44 080	35 300	17.17	3.11	3.15	3.15	1.38	1.97	2.44	37.04
ZG101295	BKLK-26-8 OS HDG	60 169	47 700	19.13	3.94	4.33	4.02	1.77	2.13	2.68	58.42
ZG101344	BKLK-32-8 OS HDG	72 300	57 745	20.98	4.72	4.33	4.02	1.77	2.44	3.39	71.21
With double latch											
ZGS1167	BKLKD-13-8 OS W HDG	15 000	12 000	12.09	1.73	2.83	2.40	0.98	1.18	1.57	11.02
ZGS1168	BKLKD-16-8 OS W HDG	22 600	18 000	14.45	1.89	3.46	3.23	1.02	1.46	1.97	19.40
ZGS1169	BKLKD-18/20-8 OS W HDG	35 300	28 300	14.49	2.05	2.36	2.83	1.22	1.73	2.56	31.53

Manufactured according to requirements in: DNV 2.7-1:2013, DNVGL-ST-0377:2016, DNVGL-ST-0378:2016 and NORSOK R-002:2017.

## Safety Hook BK and BKLK Offshore with Double Latch

With recessed trigger

Due to the motion of the sea when loading and unloading offshore, direct impact on the hook could cause the latch to unintentionally open when not being under load, risking the load to unhitch. The double latch safety hook has an extra latch retaining the load in this case.

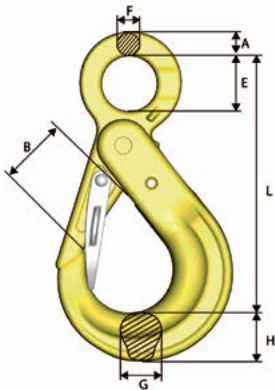

Art. no.	Code	WLL lb*	A	L	B	E	F	G	H	Weight lb
Z101154	BKD-13-10	15 000	0.79	8.15	1.73	1.77	0.63	1.18	1.57	7.05
Z101155	BKD-16-10	22 600	1.02	10.00	1.89	2.20	0.79	1.46	1.97	12.79
Z101156	BKD-18/20-10	35 300	1.18	11.42	2.05	2.36	0.87	1.73	2.44	20.06

### Double Latch

Should the hook latch accidentally open, either through direct impact or excessive wear on the trigger, the extra latch is there to retain the load safely. The extra latch is designed to be easily operated.



### Recessed Trigger

To avoid the trigger from being hit or damaged it has been recessed into the hook. This prevents the latch further from accidentally opening.

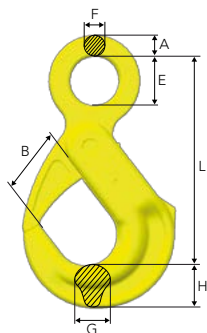

## Safety Hook BK Offshore

Art. no.	Code	WLL lb 4:1	WLL lb 5:1	L	B	E	F	G	H	Weight lb
ZG101355	BK-26-8 OS HDG	60 169	47 700	13.46	3.94	3.15	0.98	2.13	2.68	36.38
ZG101364	BK-32-8 OS HDG	72 300	57 745	15.75	4.72	3.54	1.18	2.44	3.39	51.37

Offshore material, impact toughness > 20 ft-lb (27 J) at -4°F.

Manufactured according to requirements in: DNV 2.7-1:2013, DNVGL-ST-0377:2016, DNVGL-ST-0378:2016 and NORSOK R-002:2017

See our Offshore Shackles in Chapter 4





# Increased Safety in Heavy Lifting Operations

The WRIN STR Handle is a safety handle that provides additional safety to the Gunnebo Industries' BK safety hook family. With the WRIN STR Handle the operator opens and closes the safety hook without placing any hands inside the hook, resulting in a reduced risk of personal injury on worksites. The handle is easily mounted to the safety hook, without compromising the integrity of design and capabilities of the hook.



2

## Improved workplace safety

- With the WRIN STR Handle there is no need to place a hand inside the safety hook, resulting in a reduced risk of personal injury on worksites.

## Suitable to any safety hook within the BK family

- The WRIN STR Handle is easily mounted to any safety hook within the BK family.
- For sling shops the WRIN STR Handle is the perfect complement to the BK safety hooks, reducing the need for stocking a large assortment of different safety hooks.
- If the handle is fully operable, it can be mounted and reused on a new hook if the existing hook is worn out.



## Unique design

- The handle will keep the integrity of the hook's design and capabilities uncompromised.
- The handle is clamped to the hook and fixed by the hook's trigger pin.
- Hole for attaching a lead line for easy retrieval.
- Made of quality stainless steel according to AISI 316.

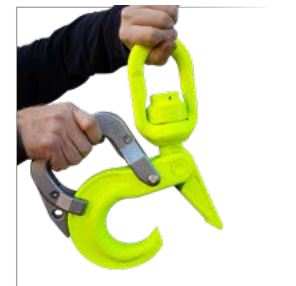

## WRIN STR Handle

Suitable to any safety hook within the Gunnebo Industries BK family.

Art. no.	Code	Hook size	Dimensions				Suits the following safety hooks:	Weight
			L	H	B	G		
Z101413	STRG13	1/2"	5.71	4.06	2.36	7.24	BK, BKG, BKL, BKLK	1.76
Z101414	STRG16	5/8"	7.17	5.51	3.15	10.04	BK, BKG, BKL, BKLK	4.08
Z101415	STRG20	3/4"	7.64	6.10	3.54	11.02	BK, BKG, BKL, BKLK	5.51
Z101416	STRG22	7/8"	7.99	6.46	3.54	11.81	BK, BKLK	5.62
Z101417	STRG26	1"	8.46	7.56	4.06	13.70	BK, BKLK	7.50
Z101418	STRG32	1 1/4"	10.35	7.05	4.06	14.96	BK, BKLK	8.71

Material: Stainless steel according to AISI 316.

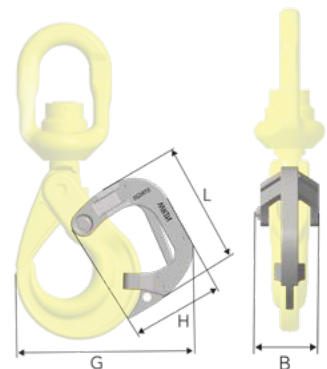

# Classic Components



**GUNNEBO**  
Industries

# The SK-system - Endless Possibilities

A range of specialized components for safe and easy assembly to chain, steel wire rope, webbing and roundsling, designed to solve your below-the-hook problems.

## The Polyester Sling System provides:

- Universal coupling of components to chain, wire and synthetic slings.
- Quick and simple assembly - only a hammer needed.
- Easy assembly - standardized dimensions within each size range effectively eliminates the incorrect assembly of components with different safe working loads.
- Heavy hoisting with strong yet lightweight equipment, all components are manufactured from alloy steel for use with Grade 8 chain.



2

## SKA - pin & collar

The SKA set, containing pin and collar, can be used to connect all products in the SK-range. This creates a multitude of available combinations, each adaptable to the unique lifting situation.

The SKA-set gives you flexibility - it can be disassembled and put in new combinations, to provide solutions for a versatile lifting environment.



## SKLI/SKLU

Electrically insulated, lubricated, sealed roller bearing swivel. Fully rotational even at maximum load. Tested to resist 1000 V. Suitable for protection of overhead cranes during welding operations on suspended loads.

By using the SKLI/SKLU with the SK-system you get a versatile solution that will fit almost any situation.

# Roller-Bearing Swivel, SKLI/SKLU

Electrically insulated, lubricated, sealed roller bearing swivel. Fully rotational even at maximum load. Tested to resist 1000 V. Suitable for protection of overhead cranes during welding operations on suspended loads.

The Gunnebo Industries SKLI is equipped with a heavy duty roller bearing, enabling high durability and safe use also under severe load. It also has heavy duty nylon insulation inside to decrease friction when in use. The SKLI is compatible with the entire Gunnebo Industries SK-range for versatile use.

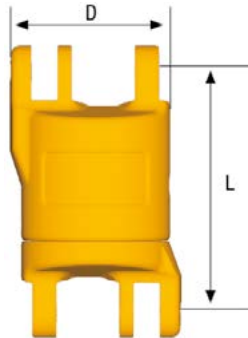

## Roller-bearing Swivel SKLI/SKLU

Art. no.	Code	WLL lb*	For chain dim.	L	D	Weight lb
Z100316	SKLI-7/8-8	4 500	9/32", 5/16"	2.95	1.89	1.54
Z100414	SKLI-10-8	7 100	3/8"	3.82	2.32	2.87
Z100415	SKLI-13-8	12 000	1/2"	4.72	2.95	6.17
Z100416	SKLI-16-8	18 000	5/8"	5.39	3.54	10.14
Z100417	SKLI-18/20-8	28 300	3/4"	159	104	16.09
RS16520	SKLU-22-8**	34 200	7/8"	160	109	20.28
RS16530	SKLU-26-8**	47 700	1"	207	135	40.34

Fulfills requirements in: EN 1677:2008, ISO 8539:2009, ASTM A952/A952M and AS 3776:2015.

\*\* Uninsulated

## Load Pin and Locking Collar - SKA



Art. no.	Code	Weight lb
Z700674	SKA-6-8	0.02
Z323624	SKA-7/8-8	0.04
Z318024	SKA-10-8	0.09
Z303822	SKA-13-8	0.18
Z303725	SKA-16-8	0.31
Z145048	SKA-18/20-8	0.57
Z133530	SKA-22-8	0.77
Z605407	SKA-26-8	1.39
Z650554	SKA-32-8	2.31

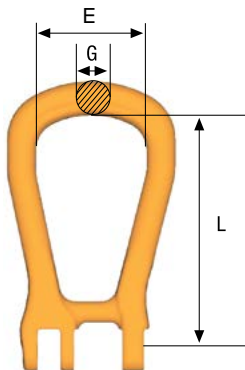

## Master Link SKG (closed)

Art, no,	Code	WLL lb*	For chain dim,	L	E	G	Weight lb
Z419684	SKG-7/8-8	4 500	9/32", 5/16"	3.90	1.97	0.55	0.66
Z419781	SKG-10-8	7 100	3/8"	5.00	2.60	0.71	1.32
Z419888	SKG-13-8	12 000	1/2"	5.71	2.83	0.87	2.43
Z419985	SKG-16-8	18 000	5/8"	6.89	3.23	0.98	3.31
Z420086	SKG-18/20-8	28 300	3/4"	8.03	4.13	1.18	6.61

Fulfills requirements in: EN 1677:2008, ISO 8539:2009, ASTM A952/A952M and AS 3776:2015.

## Master Link SKO (open)

Art. no.	Code	WLL lb*	For chain dim.	L	E	G	K	Weight lb
Z418683	SKO-7/8-8	4 500	9/32", 5/16"	3.90	1.97	0.55	0.59	0.66
Z418780	SKO-10-8	7 100	3/8"	5.00	2.60	0.71	0.79	1.32
Z419383	SKO-13-8	12 000	1/2"	5.71	2.83	0.87	0.98	2.20
Z419480	SKO-16-8	18 000	5/8"	6.89	3.23	0.98	1.18	3.31
Z419587	SKO-18/20-8	28 300	3/4"	8.03	4.13	1.18	1.42	6.39

Fulfills requirements in: EN 1677:2008, ISO 8539:2009, ASTM A952/A952M and AS 3776:2015.

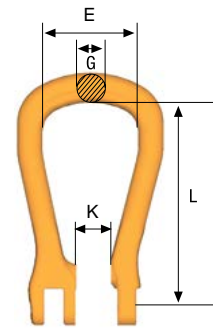

2

## Roundsling Coupling SKR

Special shape for full WLL of the roundsling.

Art. no.	Code	WLL lb*	L	B	G	K	Weight lb
Z127840	SKR-7/8-8	4 500	1.38	1.57	0.51	0.71	1.30
Z143143	SKR-10-8	7 100	1.65	1.85	0.63	0.94	1.74
Z302538	SKR-13-8	12 000	1.97	2.09	0.75	1.14	2.16
Z143240	SKR-16-8	18 000	2.44	2.64	0.91	1.38	2.60
Z143347	SKR-18/20-8	28 300	2.80	3.15	1.10	1.69	3.13
Z100057	SKR-22-8	34 200	111	125	40	50	11.68
Z100055	SKR-26-8	47 700	129	150	48	58	19.62

Fulfills requirements in: EN 1677:2008, ISO 8539:2009, ASTM A952/A952M and AS 3776:2015.

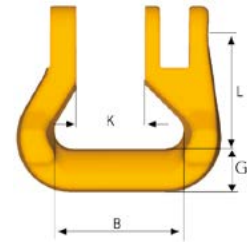

## Half-link SKT (incl. locking set)

Art. no.	Code	WLL lb*	For chain dim.	L	B	F	A	C	Weight lb
Z426286	SKT-7/8-8	4 500	9/32", 5/16"	1.10	0.71	0.35	0.43	0.87	0.22
Z426383	SKT-10-8	7 100	3/8"	1.34	0.98	0.43	0.51	1.02	0.44
Z426480	SKT-13-8	12 000	1/2"	1.73	1.18	0.59	0.63	1.30	0.88
Z426587	SKT-16-8	18 000	5/8"	2.05	1.42	0.75	0.79	1.57	1.32
Z426684	SKT-18/20-8	28 300	3/4"	2.48	1.69	0.87	0.91	1.85	2.43
Z100225	SKT-22-8	34 200	7/8"	2.99	1.97	0.94	1.02	2.32	3.75
Z100226	SKT-26-8	47 700	1"	3.15	2.28	1.18	1.30	2.40	5.73
Z100227	SKT-32-8	72 300	1-1/4"	3.94	2.76	1.50	1.57	3.07	10.80

Fulfills requirements in: EN 1677:2008, ISO 8539:2009, ASTM A952/A952M and AS 3776:2015.

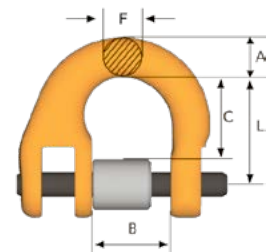

## Sling Hook ESKN/SKN with latch

Art. no.	Code	WLL lb*	For chain dim.	L	B	G	H	Weight lb
Z424682	SKN-7/8-8	4 500	9/32", 5/16"	3.54	1.06	0.71	0.83	0.88
Z424789	SKN-10-8	7 100	3/8"	4.53	1.34	0.91	1.14	1.76
Z101214	ESKN-13-8	12 000	1/2"	5.71	1.65	1.10	1.42	3.97
Z100786	ESKN-16-8	18 000	5/8"	7.01	2.13	1.50	1.69	7.50
Z100781	ESKN-18/20-8	28 300	3/4"	7.76	2.32	1.93	2.01	11.24

Fulfills requirements in: EN 1677:2008, ISO 8539:2009, ASTM A952/A952M and AS 3776:2015.

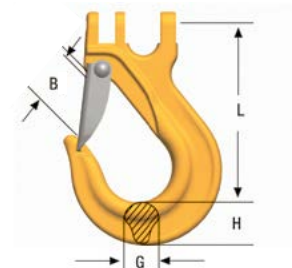

# Universal weld-on hook, UKN

## The original excavator hook

Excavators are often used for material handling and lifting as they are frequently available on most construction sites. However, rigging gear is often incorrectly attached either to the teeth of the bucket or directly on the excavator arm, which is a dangerous practice that can lead to accidents.

Back in 1975 Gunnebo Industries developed the UKN hook, a solution that transformed the excavator into a lifting crane. The UKN hook has been fitted to excavators, and other applications, for over 40 years, either as an aftermarket product or directly by the manufacturer. Today the UKN is the hook of choice for leading international excavator manufacturers.



### Quality is top priority

- Forged alloy steel
- Hardened and tempered

### 100% Proof-loaded

- Every hook is individually proof-loaded at 3 x WLL.

### High durability

- Forged
- Rated with a 5:1 safety factor

### Clear markings

- Country of origin
- Traceability code
- Model and size

### Prepared for welding

- Base plate prepared for welding



### Heavy duty latch

- Latch with handles for easy opening
- Hardened and tempered

### Pin & spring

- Spring protection
- Hardened and tempered hinge pin
- Stainless steel spring

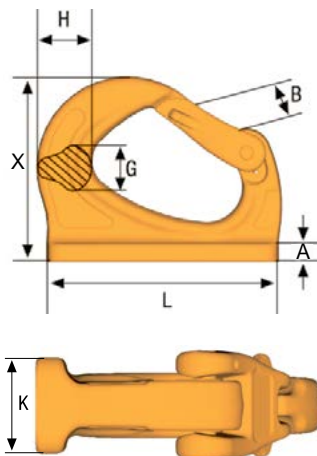

## Universal Weld-On Hook, UKN

Art. no.	Code	WLL		B	G	H	K	L	A	X	Weight lb
		metric tonnes**	pounds								
Z1002560	UKN-0.75*	0.75	1 653	0.79	0.51	0.79	0.75	3.21	0.20	2.20	0.44
Z6511810	UKN-1*	1.0	2 204	1.06	0.67	0.98	0.98	3.74	0.24	2.83	1.32
Z7009060	UKN-2*	2.0	4 500	1.30	0.79	1.18	1.18	4.49	0.31	3.39	1.98
Z6455730	UKN-3	3.0	6 612	1.18	0.91	1.26	1.38	5.20	0.39	4.13	2.87
Z6521160	UKN-4	4.0	8 800	1.18	1.14	1.50	1.65	5.51	0.43	4.49	4.41
Z6455800	UKN-5	5.0	11 020	1.34	1.18	1.85	1.77	6.50	0.47	5.16	7.05
Z6515390	UKN-8	8.0	17 632	1.34	1.57	2.01	1.97	6.77	0.51	5.24	7.94
Z6456030	UKN-10	10.0	22 040	1.85	1.69	2.28	2.17	8.66	0.55	6.69	18.08
Z1007850	UKN-15	15.0	33 060	2.17	1.97	2.64	2.36	9.45	0.59	7.40	21.61
Z1007851	UKN-20	20.0	44 080	2.56	2.36	3.35	2.36	10.83	0.59	8.15	27.34

\* Welding plate slightly curved  
 \*\* Safety factor 5:1

Fulfills requirements in: EN 474-1.

## Master Link MF

Art. no.	Code	WLL (SF 5:1) lb		L	E	D	Weight lb
		EN1677-4	A-952/A952M				
Z100860	MF-86-10	5 510	7 100	4.92	2.76	0.55	0.88
Z100861	MF-108-10	8 800	11 460	5.51	3.15	0.67	1.76
Z100862	MF-1310-10	16 530	17 632	6.30	3.74	0.87	3.31
Z100863	MF-1613-10	22 040	29 974	7.48	4.33	1.10	5.51
Z100864	MF-2016-10	37 468	45 402	9.45	5.51	1.34	11.46
Z100865	MF-2220-10	55 100	68 103	9.84	5.91	1.57	16.09

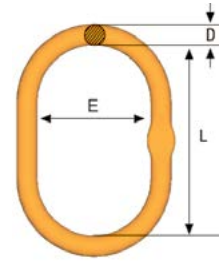

2

Fulfills requirements in: EN 1677:2008 (WLL +25%), ASTM A952/A952M and AS 3776:2015.

## Master Link with Sub Links MT

Flattened section on the sublinks.

Art. no.	Code	WLL (SF 5:1) lb		For chain 3-4-leg	L1	L	E	D	l	e	d	Weight lb
		EN1677-4	A-952/A952M									
Z100888	MT-6-10	7 714	11 020	(6mm)	10.63	5.91	3.54	0.75	4.72	2.76	0.55	3.97
Z100889	MT-8-10	11 461	17 632	9/32", 5/16"	11.81	6.30	3.74	0.87	5.51	3.15	0.67	6.61
Z100890	MT-10-10	25 346	35 300	3/8"	14.17	7.87	4.72	1.18	6.30	3.74	0.87	14.11
Z100891	MT-13-10	37 468	57 304	1/2"	17.72	9.84	5.91	1.57	7.87	4.72	1.18	31.31
Z100892	MT-16-10	61 712	77 140	5/8"	19.69	11.81	7.87	1.97	7.87	4.72	1.26	50.71

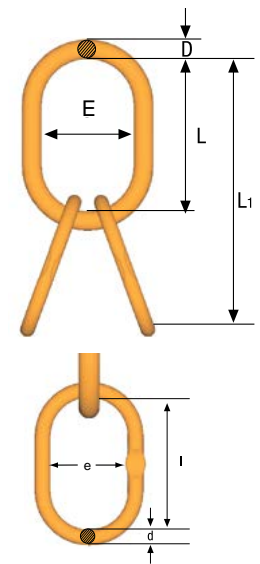

Fulfills requirements in: EN 1677:2008 (WLL +25%), ASTM A952/A952M and AS 3776:2015.

## Coupling Link G

Art. no.	Code	WLL lb *	For chain dim.	L	B	F	A	C	Weight. lb
Z622882	G-6-8	2 500	(6mm)	1.77	0.59	0.28	0.31	0.67	0.22
Z279333	G-7/8-8	4 500	9/32", 5/16"	2.20	0.71	0.35	0.43	0.87	0.44
Z279430	G-10-8	7 100	3/8"	2.68	0.98	0.43	0.51	1.02	0.66
Z279537	G-13-8	12 000	1/2"	3.50	1.18	0.59	0.63	1.30	1.54
Z279634	G-16-8	18 000	5/8"	4.13	1.42	0.75	0.79	1.57	2.65
Z279731	G-18/20-8	28 300	3/4"	4.92	1.69	0.87	0.91	1.85	4.19
Z279838	G-22-8	34 200	7/8"	5.98	1.97	0.94	1.02	2.32	6.61
Z349171	G-26-8	47 700	1"	6.34	2.28	1.18	1.30	2.40	11.46
Z349189	G-32-8	72 300	1-1/4"	7.87	2.76	1.50	1.57	3.03	20.94

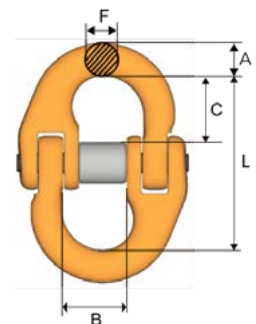

Fulfills requirements in: EN 1677:2008, ISO 8539:2009, ASTM A952/A952M and AS 3776:2015.

## Berglok Chain Coupler BL

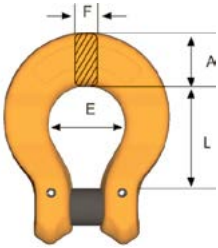

Art. no.	Code	WLL lb*	For chain dim.	L	E	F	A	Weight lb
Z622036	BL-6-8	2 500	(6mm)	1.06	0.79	0.35	0.55	0.22
Z195823	BL-7/8-8	4 500	9/32", 5/16"	1.38	0.98	0.43	0.71	0.44
Z208022	BL-10-8	7 100	3/8"	1.77	1.26	0.55	0.87	0.88
Z217820	BL-13-8	12 000	1/2"	2.20	1.57	0.67	1.10	1.76
Z208226	BL-16-8	18 000	5/8"	2.68	1.97	0.87	1.38	3.09

Fulfills requirements in: EN 1677:2008, ISO 8539:2009, ASTM A952/A952M and AS 3776:2015.

## Chain, Classic Grade 8

Short link, KL

Heat treatment

Hardened and tempered.

Heat treatment

Painted black (KLB)  
Painted yellow (KLU)

Fulfills the requirements in:

EN 818-2:2008, AS 2321:2014,  
ASTM A391/A 391M-07 (2012)

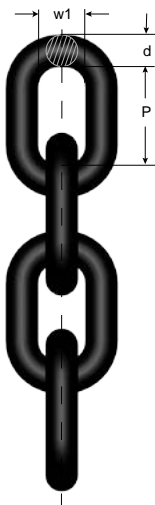

Art. no. Box	Code	WLL lb*	d nom.	P	w1	Weight lb/foot	Manufacturing proof force lb	Breaking force lb
Z802174 - 1 x 656 ft	KLB 6-8E	2 500	(6mm)	0.71	0.33	0.54	6 362	10 161
Z802175 - 1 x 656 ft	KLB 7-8E	3 500	9/32"	0.83	0.39	0.74	8 655	13 938
Z802176 - 1 x 656 ft	KLB 8-8E	4 500	5/16"	0.94	0.43	0.94	11 308	18 120
Z802156 - 1 x 328 ft	KLB 10-8E	7 100	3/8"	1.18	0.55	1.55	17 760	29 225
Z802157 - 1 x 328 ft	KLB 13-8E	12 000	1/2"	1.54	0.70	2.55	29 900	48 109
Z802177 - 1 x 328 ft	KLB 16-8E	18 000	5/8"	1.89	0.86	3.77	45 187	72 389
Z801203 - 1 x 328 ft	KLB 19-8E	25 600	3/4"	2.24	1.06	5.24	63 846	102 738
Z801228 - 1 x 164 ft	KLB 22-8E	34 200	7/8"	2.60	1.16	7.13	85 428	137 134
Z801231 - 1 x 164 ft	KLB 26-8E	47 700	1"	3.07	1.38	9.95	119 374	191 089
Z801232 - 1 x 82 ft	KLB 32-8E	72 300	1-1/4"	3.78	1.64	14.52	180 747	292 253

## Safety Hook BKG

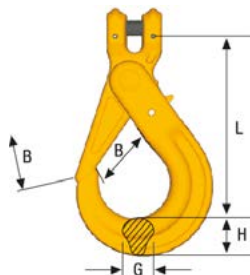

Art. no.	Code	WLL lb*	For chain dim.	L	B	G	H	Weight lb
Z297222	BKG-7/8-8	4 500	9/32", 5/16"	4.72	1.46	0.67	1.02	1.98
Z295929	BKG-10-8	7 100	3/8"	5.63	1.77	0.83	1.18	3.31
Z291527	BKG-13-8	12 000	1/2"	7.05	2.17	1.18	1.54	6.17
Z291624	BKG-16-8	18 000	5/8"	8.54	2.44	1.46	1.89	11.24

Fulfills requirements in: EN 1677:2008, ISO 8539:2009, ASTM A952/A952M and AS 3776:2015.



## Sling Hook EGKN with latch

Art. no.	Code	WLL lb*	For chain dim.	L	B	G	H	Weight lb
Z100744	EGKN-7/8-8	4 500	9/32", 5/16"	3.74	1.14	0.67	0.87	1.10
Z100772	EGKN-10-8	7 100	3/8"	4.76	1.46	0.75	1.14	1.98
Z100773	EGKN-13-8	12 000	1/2"	5.79	1.65	1.06	1.42	4.41
Z100774	EGKN-16-8	18 000	5/8"	6.69	1.93	1.34	1.73	7.94

Fulfills requirements in: EN 1677:2008, ISO 8539:2009, ASTM A952/A952M and AS 3776:2015.

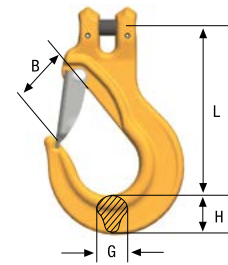

2

## Grab Hook OG

Not for use with Berglok. No reduction of working load limit, thanks to supporting lugs on either side of hook to prevent chain link deformation.

Art. no.	Code	WLL lb*	For chain dim.	L	B	E	F	Weight lb
Z100811	OG-7/8-8	4 500	9/32", 5/16"	2.56	0.39	0.63	0.39	0.66
Z291022	OG-10-8	7 100	3/8"	3.35	0.47	0.79	0.47	1.32
Z295220	OG-13-8	12 000	1/2"	4.09	0.59	0.98	0.63	2.65
Z296221	OG-16-8	18 000	5/8"	5.12	0.75	1.18	0.75	5.29

Fulfills requirements in: EN 1677:2008, ISO 8539:2009, ASTM A952/A952M and AS 3776:2015.

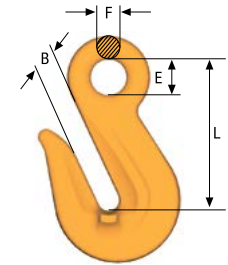

## Safety Hook with Griplatch OBK

Art. no.	Code	WLL lb*	For chain dim.	A	L	B	E	F	G	H	Weight lb
Z100218	OBK-22-8	34 200	7/8"	1.18	13.19	3.43	2.76	0.94	1.57	2.24	22.49

Fulfills requirements in: EN 1677:2008, ISO 8539:2009, ASTM A952/A952M and AS 3776:2015.

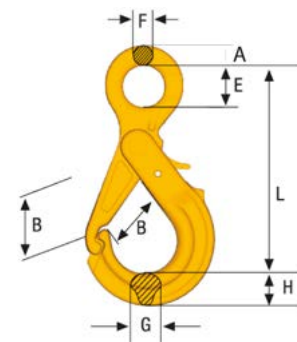

## Safety Hook BK

Art. no.	Code	WLL lb*	For chain dim.	L	B	E	F	G	H	Weight lb
Z101357	BK-32-8	72 300	1-1/4"	15.75	4.72	3.54	1.18	2.44	3.39	23.8

Fulfills requirements in: EN 1677:2008, ISO 8539:2009, ASTM A952/A952M and AS 3776:2015.

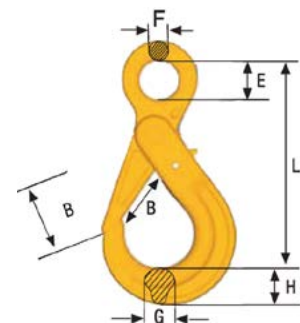

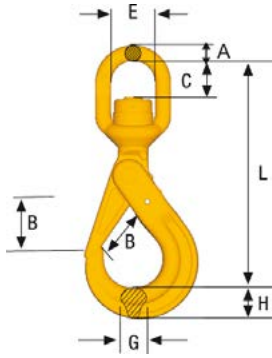

## Swivel Safety Hook BKLK

Safety hook with ball-bearing for 360° rotation under full load.

Art. no.	Code	WLL lb*	For chain dim.	L	B	C	E	A	G	H	Weight lb
Z101344	BKLK-32-8	72 300	1-1/4"	20.98	4.72	4.33	4.02	1.77	2.44	3.39	71.21

Fulfills requirements in: EN 1677:2008, ISO 8539:2009, ASTM A952/A952M and AS 3776:2015.

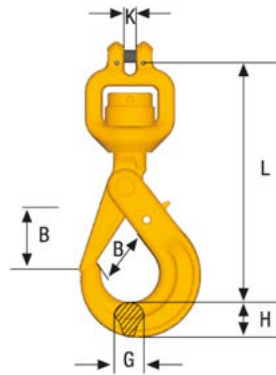

## Clevis Swivel Safety Hook BKH

Safety hook with swivel for improved positioning of the hook before the load is lifted (360° rotation).

Art. no.	Code	WLL lb*	For chain dim.	L	B	K	G	H	Weight lb
Z336222	BKH-6-8	2 500	(6mm)	5.71	1.14	0.27	0.59	0.83	1.54
Z700809	BKH-7/8-8	4 500	9/32", 5/16"	7.13	1.46	0.35	0.67	1.02	2.65

Fulfills requirements in: EN 1677:2008, ISO 8539:2009, ASTM A952/A952M and AS 3776:2015.

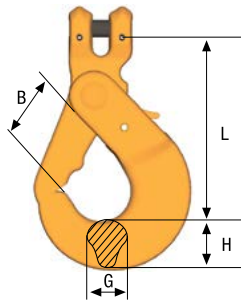

## Container Hook BKGC

Art. no.	Code	WLL lb*	For chain dim.	L	B	G	H	Weight lb
Z100242	BKGC-16-8	18 000	5/8"	6.30	2.17	1.06	1.69	7.50

Fulfills requirements in: EN 1677:2008, ISO 8539:2009, ASTM A952/A952M and AS 3776:2015.

Spare part: RDOBK

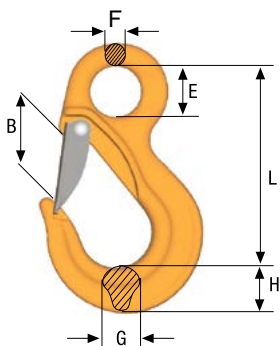

## Sling Hook EK (without latch) and EKN (with latch)

Art. no.	Code	WLL lb*	For chain dim.	L	B	E	F	G	H	Weight lb	
<b>EN 1677-2</b>											
Z100720	EK-32-8	72 300	1-1/4"	13.11	4.13	2.99	1.50	2.40	3.15	39.02	
Z100725	EKN-32-8	72 300	1-1/4"	13.11	3.66	2.99	1.50	2.40	3.15	39.46	

Fulfills requirements in: EN 1677:2008, ISO 8539:2009, ASTM A952/A952M and AS 3776:2015.

**DIN 7540 - Also available in ROV version on request**

Z101382	DK-50T-8	110 200		17.40	4.88	5.12	1.99	3.50	4.57	100.31
Z101361	DKN-50T-8	110 200		17.40	4.88	5.12	1.99	3.50	4.57	101.41
Z101384	DK-80T-8	176 320		24.02	6.10	4.02	2.48	4.33	5.71	175.27
Z101363	DKN-80T-8	176 320		24.02	6.10	4.02	2.48	4.33	5.71	176.37

Fulfills requirements in: EN 1677:2008, ISO 8539:2009, ASTM A952/A952M and AS 3776:2015.

## Foundry Hook OKE

Art. no.	Code	WLL lb*	For chain dim.	L	B	E	F	G	H	Weight lb
Z645564	OKE-32-8	72 300	1-1/4"	15.12	5.71	3.54	1.65	3.03	3.70	66.14

Fulfills requirements in: EN 1677:2008, ISO 8539:2009, ASTM A952/A952M and AS 3776:2015.

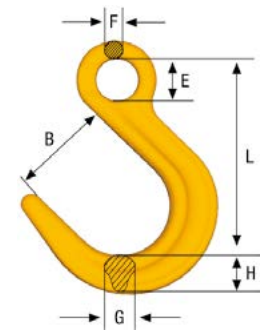

2

## Clevis Shackle GSA

EN 1677-1      Grade 8  
 Finish:          Painted yellow  
 Material:        Alloy steel  
 Safety factor:   4:1

Art. no.	Code	WLL metric tonnes	For chain dim.	a	c	d2	l	d1	Weight lb
Z700882	GSA-7/8-8	2.0	9/32", 5/16"	1.26	1.42	1.34	2.36	0.63	0.88
Z700883	GSA-10-8	3.2	3/8"	1.34	1.89	1.57	3.15	0.79	1.76
Z700884	GSA-13-8	5.4	1/2"	1.97	2.56	1.73	3.86	0.87	3.09
Z700885	GSA-16-8	8.2	5/8"	2.36	2.76	2.13	4.49	1.06	5.29

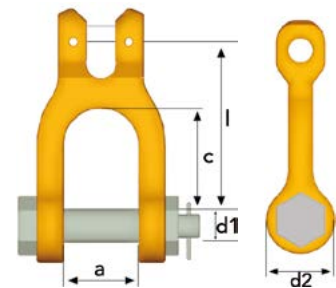

## Clevis Egglink CEL

Art. no.	Code	WLL lb*	For chain dim.	C	E	G	H	L	Weight lb
Z700968	CEL-7/8-8	4 500	9/32", 5/16"	3.15	1.57	0.55	0.59	3.94	0.88
Z700969	CEL-10-8	7 100	3/8"	3.94	1.97	0.71	0.75	4.96	1.54
Z700970	CEL-13-8	12 000	1/2"	5.12	2.56	0.91	0.98	6.38	3.31

Fulfills requirements in: EN 1677:2008, ISO 8539:2009, ASTM A952/A952M and AS 3776:2015.

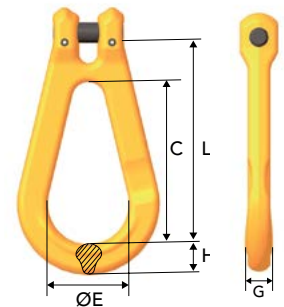

## Coupling Link GF - Stain Proof\*\*

High strength stainless steel.

Art. no.	Code	WLL lb*	For chain dim.	L	B	F	A	C	Weight lb
B80202	GF-10-8 SP	7 100	3/8"	2.68	0.98	0.43	0.51	1.02	0.66
B80203	GF-13-8 SP	12 000	1/2"	3.50	1.18	0.59	0.63	1.30	1.54
B80204	GF-16-8 SP	18 000	5/8"	4.13	1.42	0.75	0.79	1.57	2.65

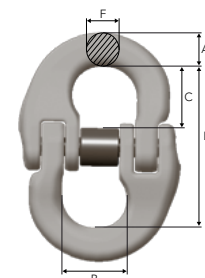

\* Values converted from metrics and rounded  
 \*\*This product comes with a straight pin without recession.

# Hot Dip Galvanized Product Range

The HDG lifting range is designed to meet the specific challenges from corrosive environments in which they will have a longer lifetime. They require less maintenance than standard products, which means that the HDG products are more cost effective in the long run.

## A longer life span

The HDG coating prolongs the life time for equipment in corrosive environments significantly. Not just in costal and maritime areas but also in industrial plants and buildings with high humidity.

## Protective coating with high impact and wear resistance

The HDG coating forms a flexible metallurgical bond with the steel, which gives outstanding resistance to mechanical damage during transport and service. The coating also provides an automatic protection to small areas of exposed steel, which means that minor damages need no touch-up.

## Easy inspections and lower maintenance costs

Our HDG lifting components are easily inspected visually; if the coating appears sound and continuous, then it is. Simple and quick means improved productivity.

## We are a provider of Peace of mind

Production and galvanizing of products that are sensitive for hydrogen embrittlement requires an in-depth material- and process knowledge. Each element within the manufacturing process is stringently controlled with our in-house quality systems; this also applies to our galvanizing and heat treating procedures which are critical factors in the product performance. Our products are manufactured to exact demands and with preventive actions taken to avoid hydrogen embrittlement in the material.

## Technical Information

Standards:	Quality assurance:	What is hot dip galvanizing (HDG)?:
<ul style="list-style-type: none"> <li>EN 1677-1:2008</li> <li>EN 1677-3:2008</li> <li>EN 1677-4:2008</li> <li>EN 818-1:2008</li> <li>EN 818-2:2008 (material dim. Ø +10%)</li> <li>AS2321:2014</li> <li>ASTM A391/A391M-07</li> <li>ISO 1461:2009</li> <li>Applicable parts of NS9415:2009</li> </ul>	<ul style="list-style-type: none"> <li>Fatigue tested construction.</li> <li>Full traceability back to the raw material.</li> <li>Strict controls throughout the whole process.</li> <li>Measurement of coating thickness on random samples from every batch.</li> <li>100% proof load of every single component.</li> <li>Visual inspection.</li> </ul>	<ul style="list-style-type: none"> <li>Hot-dip galvanizing is the process of coating steel with a layer of zinc for added corrosion resistance.</li> <li>It involves immersing the steel material in molten zinc through a multi-step galvanizing line.</li> <li>The resulting material is encased in several layers of zinc and zinc-iron alloys, making it extremely tough.</li> </ul>
Material:	Temperature range:	Documentation:
<ul style="list-style-type: none"> <li>High tensile steel, hardened and tempered.</li> <li>Hot dip galvanized coating according to ISO 1461-2009.</li> </ul>	<p>-40 °F to 392 °F.</p>	<p>Inspection certificate acc. EN-10204 - 3.1</p>



## Master Link MF HDG

Art. no.	Code	WLL (SF 5:1) lb		L	E	D	Weight lb
		EN1677-4	A-952/A952M				
BG14481	MF-86-8 HDG	4500	4500	4.92	2.76	0.55	1.10
BG14482	MF-108-8 HDG	7100	7100	5.51	3.15	0.67	1.76
BG14483	MF-1310-8 HDG	12000	12000	6.30	3.74	0.87	3.31
BG14484	MF-1613-8 HDG	18000	18000	7.48	4.33	1.1	6.17

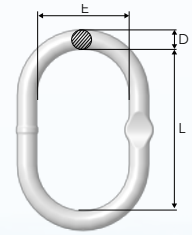

## Chain KLZ HDG

Art. no.	Code	WLL lb*	d nom.	p	w1	Weight lb	MPF lb	Breaking force lb	Delivery length
ZG802306	KLZ-6-8 HDG	2500	0.26	0.71	0.35	2.20	8200	10160	1 x 328 ft
ZG802307	KLZ-8-8 HDG	4500	0.35	0.94	0.44	3.75	14100	18000	1 x 328 ft
ZG802308	KLZ-10-8 HDG	7100	0.43	1.18	0.57	5.73	22000	28400	1 x 328 ft
ZG802309	KLZ-13-8 HDG	12000	0.56	1.54	0.76	9.92	37300	48000	1 x 328 ft
ZG802310	KLZ-16-8 HDG	18000	0.68	1.89	0.91	14.8	56400	72400	1 x 328 ft

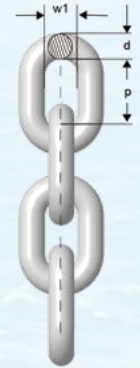

## Safety Hook BK HDG

Art. no.	Code	WLL lb*	A	L	B	E	F	G	H	Weight lb
ZG101108	BK-6-8 HDG	2500	0.47	4.29	1.14	0.87	0.39	0.59	0.83	1.10
ZG101097	BK-7/8-8 HDG	4500	0.55	5.43	1.46	1.10	0.43	0.67	1.02	1.98
ZG101024	BK-10-8 HDG	7100	0.63	6.61	1.77	1.34	0.51	0.83	1.22	3.31
ZG101032	BK-13-8 HDG	12000	0.79	8.15	2.17	1.73	0.63	1.18	1.57	6.61

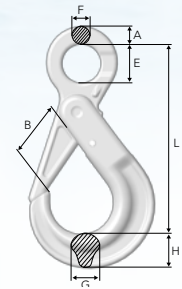

## Swivel Safety Hook BKL HDG

Art. no.	Code	WLL lb*	L	B	C	E	A	G	H	Weight lb
ZG101028	BKL-10-8 HDG	7100	8.58	1.77	1.46	1.73	0.59	0.83	1.22	4.41
ZG101036	BKL-13-8 HDG	12000	11.10	2.17	1.93	1.89	0.75	1.18	1.57	8.82

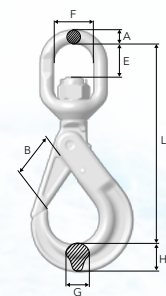

## Coupling Link G HDG

Art. no.	Code	WLL lb*	L	B	F	A	C	Weight lb
ZG100821	G-6-8 HDG	2500	1.77	0.59	0.28	0.31	0.67	0.22
ZG100822	G-8-8 HDG	4500	2.20	0.71	0.35	0.43	0.87	0.44
ZG100823	G-10-8 HDG	7100	2.68	0.98	0.43	0.51	1.02	0.66
ZG100824	G-13-8 HDG	12000	3.50	1.18	0.59	0.63	1.30	1.54

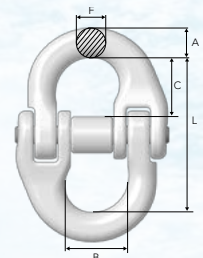

## Spare Part RD BK

(with assembly kit)

Set for BK/BKG Safety hooks consisting of trigger, stainless steel spring, retaining pin and assembly kit.

### Recessed trigger



Art. no.	Code	Weight lb
Z100282	RDBK-6	0.04
Z100283	RDBK-8	0.07
Z100284	RDBK-10	0.07
Z100285	RDBK-13	0.11
Z100286	RDBK-16	0.22
Z100297	RDBK-18/20	0.46
Z100287	RDBK-22	0.44
Z100280	RDBK-26	1.10
Z100294	RDBK-32	1.54
Z1002970	RDBK 18/20 OS	0.46
Z1002870	RDBK-22 OS	0.44
Z1002950	RDBK-26OS	1.102
Z1002940	RDBK-32OS	1.543

### Standard trigger (long trigger)

Art. no.	Code	Weight lb
Z1002820	RDBK-6	0.02
Z1002830	RDBK-8	0.07
Z1002840	RDBK-10	0.07
Z1002850	RDBK-13	0.11
Z1002860	RDBK-16	0.26

## Spare Part RD OBK / GBK

(with assembly kit)

Set for OBK/GBK Safety hooks consisting of trigger, stainless steel spring, retaining pin and assembly kit.



Art. no.	Code	Weight lb
Z100281	RDOBK-6	0.02
Z100288	RDOBK-7/8	0.04
Z100289	RDOBK-10	0.07
Z100290	RDOBK-13	0.11
Z100291	RDOBK-16	0.18
Z100297	RDOBK-18/20	0.46
Z100323	RDOBK-22-8	0.77

## Spare Part RD BKD / BKLKD

(with assembly kit)



Art. no.	Code	Weight lb
Z101157	RDBKD-13 double latch	0.49
Z101158	RDBKD-16 double latch	0.93
Z101159	RDBKD-18/20 double latch	1.04

## Spare Part RD GKN / OKN

Art. no.	Code	Weight lb
Z622175	RDGKN/OKN-7/8-8	0.11
Z622183	RDGKN/OKN-10-8	0.20
Z622206	RDGKN/OKN-13-8	0.29
Z622214	RDGKN-16-8	0.49



2

## Spare Part RD LKNG

Art. no.	Code	Weight lb
Z700495	RDLKNG-16 Bolt and Nut	1.54
B60122	RDLKNG-16 Bronze Washer and Retaining pin	0.07



## Spare Part RDGG

Spare part set consisting of pin, spring and locking ring.

Art. no.	Code	Weight lb
B17930	RDGG-8-10 locking pin	0.07
B17931	RDGG-10-10 locking pin	0.09
B17932	RDGG-13-10 locking pin	0.11
B17933	RDGG-16-10 locking pin	0.13

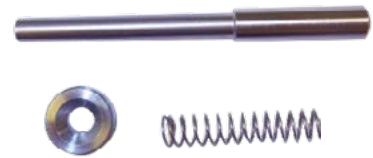

## Spare Part LKN / LKNK / EKN / OKN / EGKN / RH / ESKN

Set consisting of latch, stainless steel spring and rivet.

Art.no.	Code	Weight lb
Z100445	RDEKN- 6 / OKN / RH 1	0.07
Z100447	RDEKN- 7/8 /LKN / RH 2	0.11
Z100450	RDEKN-10 / LKN / RH 3	0.13
Z100449	RDEKN-13 / LKN / RH 5	0.29
Z100217	RDEKN-16 / LKN	0.44
Z100453	RDEKN-18/20	0.57
Z100452	RDEKN-22	0.93
Z100742	RDEKN-26	1.17
Z100743	RDEKN-32	1.32



## Spare Part Set SKN, OKN and LKN (old version)

Set consisting of latch, stainless steel spring and rivet.

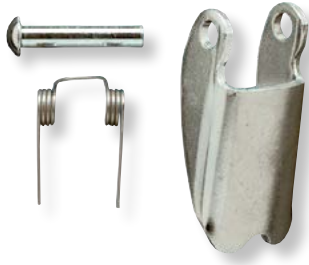

Art. no.	Code	Weight lb
Z420581	RDSKN/LKN-7/8-8	0.11
Z420688	RDSKN/LKN-10-8	0.22
Z420785	RDSKN/LKN-13-8	0.31
Z420989	RDSKN/OKN-16-8	0.49
Z421087	RDSKN/OKN-18/20-8	0.60
Z700698	RDOKN-22-8	1.06

## Spare Part UKN

Spare part set RDUKN (msp) consisting of forged latch, pin, stainless steel spring and retaining pin.

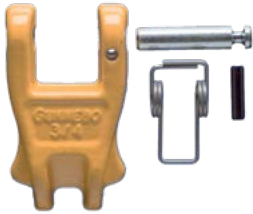

Art. no.	Code	Weight lb
Z100258	RDUKN-0.75	0.13
Z700264	RDUKN-1	0.26
Z700958	RDUKN-2	0.44
Z700266	RDUKN-3/4	0.44
Z700268	RDUKN-5/8	0.79
Z700269	RDUKN-10	1.94
Z700984	RDUKN-15	2.65

## Id-tag grade 8

Stainless steel.

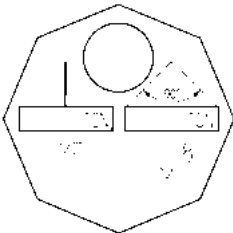

Art.no.	Code
Z100004	Id-tag

## Sling Id-tag Grade 10

Stainless steel. Sling Id-tag Grade 10 acc. to EN 818



Art. no.	Code
B14841	Flexitag 6 mm with ferrule and wire
B14842	Flexitag 8 mm with ferrule and wire
B14843	Flexitag 10 mm with ferrule and wire
B14844	Flexitag 13 mm with ferrule and wire
B14845	Flexitag 16 mm with ferrule and wire
Z100971	Flexitag 6 mm
Z100972	Flexitag 8 mm
Z100973	Flexitag 10 mm
Z100974	Flexitag 13 mm
Z100975	Flexitag 16 mm
Z101077	Flexitag 20 mm
Z100899	Flexitag Neutral



Stainless steel. Sling Id-tag Grade 10 acc. to ASME

Art. no.	Code
697053	US/CANADA FLEXI LEG TAG KIT (6MM)
697054	US/CANADA FLEXI LEG TAG KIT 5/16"
697055	US/CANADA FLEXI LEG TAG KIT 3/8"
697056	US/CANADA FLEXI LEG TAG KIT 1/2"
697057	US/CANADA FLEXI LEG TAG KIT 5/8"



2

## Load Pin Set CLS

Clevis connection set consisting of one load pin and one spring retaining pin.

Art. no.	Code	Weight lb/ea
B14930	CLS- 6	0.02
B14931	CLS- 8	0.04
B14932	CLS-10	0.09
B14933	CLS-13	0.20
B14934	CLS-16	0.35
B14935	CLS-20	0.57

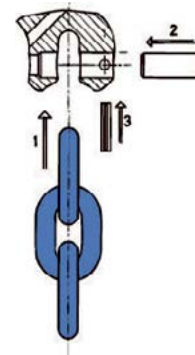

## Spare Part CS

C-connection set for CG, CGD, CL, CLD and RH hook, consisting of one blocking pin and one spring retaining pin, for locking.

Art. no.	Code	Weight lb/ea
B14920	CS- 6-10	0.02
B14921	CS- 8-10 / RH-1& -2	0.02
B14922	CS-10-10 / RH-3	0.02
B14923	CS-13-10	0.07
B14924	CS-16-10 / RH-5	0.11

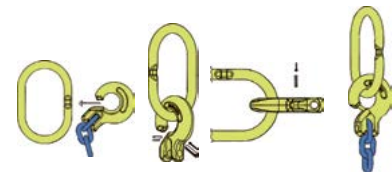

Assembly: C-coupling - C-grab/C-lok with MF

## Close/Open Locking Set FlexiLeg Quick Pin

Art. no.	Code	Weight lb
Z101010	QP-6-10	0.02
Z101011	QP-8-10	0.02
Z101012	QP-10-10	0.02
Z101013	QP-13-10	0.07
Z101014	QP-16-10	0.13

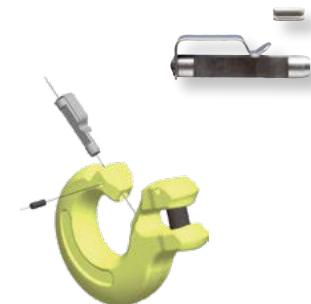

## Locking Set SKA

SKA locking set for G-link, consists of a load pin and locking collar.

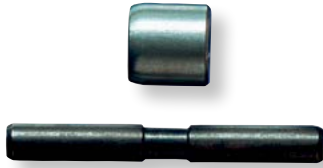

Art. no.	Code	Weight lb
Z100989	SKA- 6-10	0.02
Z100933	SKA- 7/8-10	0.04
Z100934	SKA-10-10	0.09
Z100990	SKA-13-10	0.18
Z100991	SKA-16-10	0.31
Z101176	SKA-20-10	0.57
Z650555	SKA-22-10	0.77
Z650556	SKA-26-10	1.39
Z650557	SKA-32-10	2.40

Art. no.	Code	Weight lb
Z700674	SKA-6-8	0.02
Z323624	SKA-7/8-8	0.04
Z318024	SKA-10-8	0.09
Z303822	SKA-13-8	0.18
Z303725	SKA-16-8	0.31
Z145048	SKA-18/20-8	0.57
Z133530	SKA-22-8	0.77
Z605407	SKA-26-8	1.39
Z650554	SKA-32-8	2.31

## Load Pin Set Berglok BLA

Set for Berglok and Clevis type connections. Consists of one load pin and two retaining pins.



Art. no.	Code	Weight lb
Z275649	BLA-6-8*	0.02
Z275347	BLA-7/8-8*	0.04
Z275444	BLA-10-8	0.09
Z275648	BLA-13-8	0.18
Z276047	BLA-16-8	0.33
Z276241	BLA-19-8	0.57

\* Also for Safety hook BKH

## Locking Set Midgrab MIG

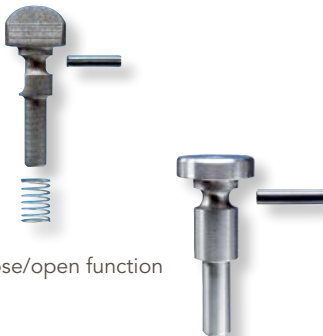

C - Close/open function

L - Permanent locking function

Art. no.	Code	Weight lb
B14904	C-8	0.04
B14905	L-8	0.04
B14914	C-10	0.04
B14915	L-10	0.04
B14916	C-13	0.18
B14917	L-13	0.11



**GUNNEBO**  
Industries

1<sup>st</sup> choice in lifting and rigging  
since 1764.

2

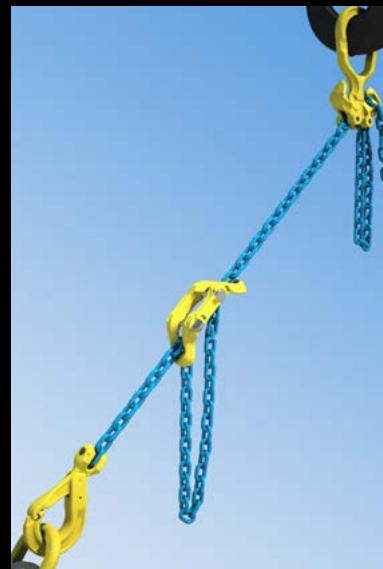

# Technical information

The following information aims to give advice and explain the most common questions in order to ensure safe and proper use of lifting equipment.

It is of the utmost importance that this information is known to the user, and in accordance with the Machinery Directive 2006/42/EC this information must be delivered to the customer.

See website or user instructions for assembly instructions.

Meets listed current specifications and standards at time of publication of this catalogue.

All G80 and G100 Alloy Chains, and Alloy components meet or exceed the safety standards as prescribed by ASME B30.9 and OSHA 1910-184 for slings. Always comply with applicable International, National, Federal and local regulations as they govern worksite activity. Understand all governing laws and safety standards before any products are used. Contact your International, National, Federal and local standards and regulations organizations for reference assistance.

## Extreme Environments

The in-service temperature effects the WLL as follows:

Temperature (°F)	Reduction of WLL			
	Grade 10 chain (400)	Grade 10 chain (200)	Grade 10 components	Grade 8 chain & components
-40 to +392 °F	0 %	0 %	0 %	0 %
+392 to +572 °F	10 %	Not allowed	10 %	10 %
+572 to +752 °F	25 %	Not allowed	25 %	25 %

Upon return to normal temperature, the sling reverts to its full capacity within the above temperature range. Chain slings should not be used above or below these temperatures. **Note! A chain sling with Grade 10 (200) chain must not be used in temperatures above 392 °F.**

- Chain and components must not be used in alkaline (>pH10) or acidic conditions (<pH6).
- Comprehensive and regular examination must be carried out when used in severe or corrosive inducing environments.
- In uncertain situations consult your Gunnebo Industries dealer.

## Surface Treatment

**Note!** Hot-dip galvanizing or plating is not allowed outside the control of the manufacturer.

## Protect Yourself and Others

- Before each use the chain sling should be checked for obvious damage or deterioration.
- Know the weight of the load, the center of gravity and ensure it is ready to move and no obstacles will obstruct the lift.
- Check the conformity of the load with the WLL of the ID tag for the specific working configuration. Never use a sling without a legible valid ID tag!
- Prepare the landing site.
- Never overload a sling and avoid shock loading.
- Never use an improper sling configuration.
- Never use a worn out or damaged sling.
- Never ride on the load.
- Never walk or stand under a suspended load.
- Take into consideration that the load may swing or rotate.
- Watch your feet and fingers while loading/unloading.
- Always ensure that your back is clear.

## General Advice

- Ensure that the sling is precisely as ordered.
- Ensure that the manufacturers certificate is in order.
- A metal I.D. Tag must always be attached to a chain sling, showing serial number, size, reach, rated capacity at angle of lift and manufacturer.
- Ensure that all details of the chain sling are recorded.
- Ensure that the staff using the chain sling has received the appropriate information and training.

## Asymmetrical Loading Conditions

For unequally loaded chain legs we recommend that the WLL are determined as follows:

- 2-leg slings calculated as the corresponding 1-leg sling
- 3 and 4-leg slings calculated as the corresponding 1-leg sling. (If it is certain that 2-legs are equally carrying the major part of the load, it can be calculated as the corresponding 2-leg sling.

# Safe use

## Machining and threading specifications for BKT shank hook

- BKT self-locking hook shank machining limits are defined and are given in TABLE 2 and these limits are required for WLLs given on page 2:16. Failure to comply can result in stripped threads and loss of load. Hook shank threads shall end with a thread relief. Hook shank shall not be swaged to wire rope or rod. Hook shank shall not be drilled and internally threaded.
- Gunnebo Industries cannot assume responsibility for:
  - Machining quality,
  - Application,
  - Attachment to power source or load.

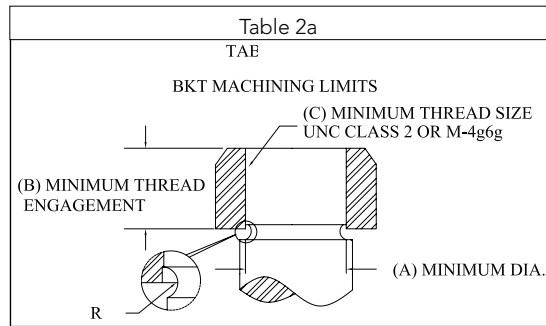

English				
Trade Size	(A)	(B)	(C) Min. Thread	
MM	IN	Dia.	Len.	Class 2
5/6	7/32	.430	.563	9/16-12 UNC
7/8	9/32	.485	.625	5/8-11 UNC
10	3/8	.600	.750	3/4-10 UNC
13	1/2	.820	1.00	1-8 UNC
16	5/8	1.048	1.25	1-1/4-7 UNC

Metric				
Trade Size	(A)	(B)	(C) Min. Thread	
MM	IN	Dia.	Len.	Class 4g6g
5/6	7/32	11	14	M14x2
7/8	9/32	13	16	M16x2
10	3/8	16	20	M20x2.5
13	1/2	20	24	M24x3
16	5/8	25	30	M30x3.5

## Safe use of self-locking hook

- Alloy steel BK self-locking hooks may be used to rig personnel platforms when lift system is in full compliance with OSHA 1926.1501(g) and passing the applicable inspection criteria.
- Loads shall be centered in the base (bowl/ saddle) of hook to prevent point loading of the hook. (See Figure 1a, 1b & 1c).
- Hooks shall not be used in such a manner as to place a side load or back load on the hook. (See Figure 2a & 2b).
- When using a device to close the throat opening of the hook, care shall be taken that the load is not carried by the closing device. (See Figure 3a & 3b).
- Hands, fingers and body shall be kept from between hook and load.
- The use of a hook with a latch does not preclude the inadvertent detachment of a slack sling or a load from the hook. Visual verification of proper hook engagement is required in all cases.
- Self-locking hooks shall be locked during use.
- When a hook is equipped with a latch, the latch should not be restrained from closing during use.
- Self-locking hooks shall not be rigged with more than two (2) sling legs in the hook saddle and sling leg angles shall not be greater than 45° from hook centerline. (Figure 1b).
- Self-locking hooks shall be rigged with a master ring or shackle when three (3) or more sling legs are used or sling leg angles exceed 45° from hook centerline. (Figure 1c).

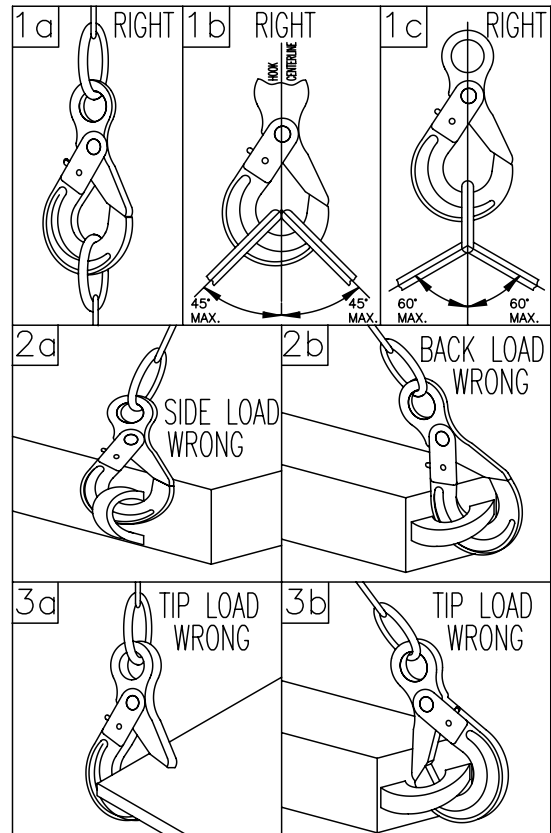

## Safe use

A chain sling is usually attached to the load and the crane by means of terminal fittings such as hooks, links etc.

When frequently using a sling to its maximum load, we recommend increasing the sling size by one dimension.



Chain should be without twists or knots, if the chain leg needs length adjustment use a shortening device. The lifting point should be seated well down in the terminal fitting, never on the point or wedged in the opening. The terminal fitting should be free to incline in any direction.

The chain may be passed under or through the load to form a choke hitch or basket hitch. The chain should be allowed to assume its natural angle and should not be hammered down.

Where choke hitch is employed the WLL of the chain sling shall be reduced by 20%.

Endless chain slings shall be rated in the same way as a 2-legged sling.

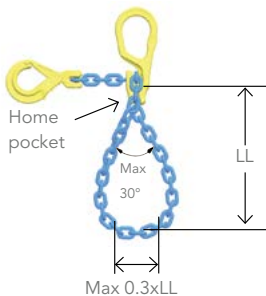

Home pocket loop shall have an internal loop top angle of max. 30°. Rule of thumb: Cross dimension of the load shall be max. 0.3 times the loop length (LL)

Definition: The home pocket is the shortening pocket of the top component directly above the clevis to which the chain is connected.

## Sharp edges

Use edge protectors to prevent sharp edges from damaging the chain. If lifting over sharp edges reduce the working load with the following reduction tor.

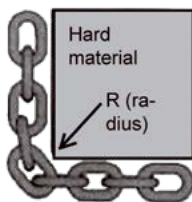

Edge load	$R > 2 \times \text{chain } \varnothing$	$R > \text{chain } \varnothing$	$R < \text{chain } \varnothing$
Reduction factor	1.0	0.7	0.5

- The angle of the edge must not be below 90°.
- Chain links shall be protected from being bent or deformed and from receiving cuts or gouges.
- Chain sling WLL is to be reduced when chain is rigged over an edge radius R less than two (2) x chain diameter (d).
- Reduced WLL equals chain sling WLL from identification tag x reduction factor.
- Slings shall be padded or protected from the edges of their loads when the edge radius is less than 0.5 of the chain diameter(d).
- Slings shall be rigged to prevent chain from sliding over a load edge radius while lifting.
- Slings used in basket hitch shall have the loads balanced to prevent slipping.

When lifting with chain directly on lugs the lug diameter > 3x the pitch of the chain, otherwise the WLL must be reduced by 50%.

## Maintenance

Periodic thorough examination must be carried out at least every 12 months or more frequently according to local statutory regulations, type of use and past experience.

- Overloaded chain slings must be taken out of service.
- If the lifting equipment is more than 25 years old, it must be recorded in the inspection register. An investigation into both its previous operating history and its current use should be made, as there is a potentially significant risk of fatigue, environmental impact etc.
- Chain and components including load pins which have been damaged, deformed, elongated, bent or showing signs of cracks or gouges shall be replaced. Carefully grind away small sharp cuts and burrs. Additional testing by magnetic particle inspection and/or proof loading at max. 2 x WLL may be carried out.
- The maximum permissible increase in hook aperture must not exceed 10% of the products nominal dimension.
- Check the function of latches, triggers and retaining pins / bushes, replace when necessary. Always use Gunnebo Industries original spare parts.
- Max. clearance between hook and latch. Note: For a Griplatch hook measure the difference between dimension A with unloaded spring and dimension A when the latch is pressed against the hook. Clearance B not applicable.

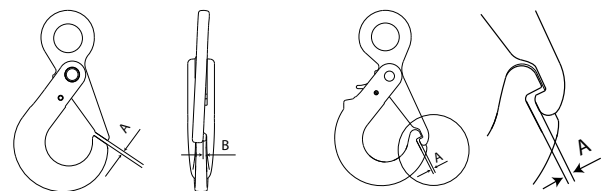

Trade size		Max. clearance (A)				Max. clearance (B)	
		Material handling		Personnel handling		(NA for griplatch hooks)	
mm	inch	mm	inch	mm	inch	mm	inch
6	7/32	2.2	0.09	1.5	0.06	3.5	0.14
7/8	9/32	2.7	0.11	1.9	0.07	4.5	0.18
7	9/32	2.7	0.11	1.9	0.07	4.5	0.18
8	5/16	2.7	0.11	1.9	0.07	4.5	0.18
10	3/8	3.0	0.12	2.1	0.08	6.0	0.24
13	1/2	3.3	0.13	2.3	0.09	7.0	0.28
16	5/8	4.0	0.16	2.8	0.11	9.0	0.35
18/20	3/4	5.5	0.22	3.9	0.15	10.0	0.39
22	7/8	6.0	0.24	4.2	0.17	11.0	0.43
26	1	6.5	0.26	4.6	0.18	12.0	0.47
32	1 1/4	7.0	0.28	4.9	0.19	13.0	0.51

- The wear of the chain and component shall in no place exceed 10% of the products nominal dimension. The chain link wear is defined and measured as the reduction of the mean diameter measured in two perpendicular directions, see picture.

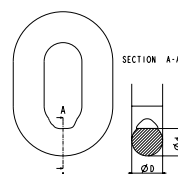

$$\frac{d_1 + d_2}{2} > 0.9d_{nn}$$

$d_n$  = nominal diameter

# Quality assurance

## Type testing

In order to prove the design, material, heat treatment and method of manufacture, each size of component and chain has been type tested in the finished condition in order to demonstrate that the component and chain possesses the required mechanical properties. The following testing procedures are particularly relevant:

### Test for deformation

The Manufacturing Proof Force (MPF) for the relevant size of the component is applied and removed. The dimensions after proof loading shall not alter from the original dimensions within the tolerances prescribed in our specifications and in the international standards.

### Static tensile test

The Breaking Force (BF) for each component and size is verified. The verified value shall be at least equal to the Minimum Breaking Force (MBF) value. The MBF value is equal to the Working Load Limit (WLL) multiplied by the safety factor.

### Fatigue test

By fatigue testing in pulsator testing machines the toughest conditions of service are simulated.

## Manufacturing testing

During manufacture continuous process tests are carried out according to the requirements in our specifications and in the latest international standards. The following testing procedures are particularly relevant:

### Non destructive test

3% of every production batch of forged components are subject to magnetic particle or dye penetrating examination.

### Proof force / visual inspection

Each individual component and chain link is tested to the Manufacturing Proof Force (MPF) level before delivery. The MPF level is 2.5 times the WLL, equal to 62.5% of the Minimum Breaking Force. Visual inspection is carried out on each chain link and each forged component to detect defects.

### Static tensile and ultimate elongation test

During chain manufacture, samples are tested and the Minimum Breaking Force (MBF) value and the total ultimate elongation are verified.

### Bending deflection

During manufacturing, of chain and master links, samples are taken and the minimum bend deflection is verified.

Stress / elongation diagram

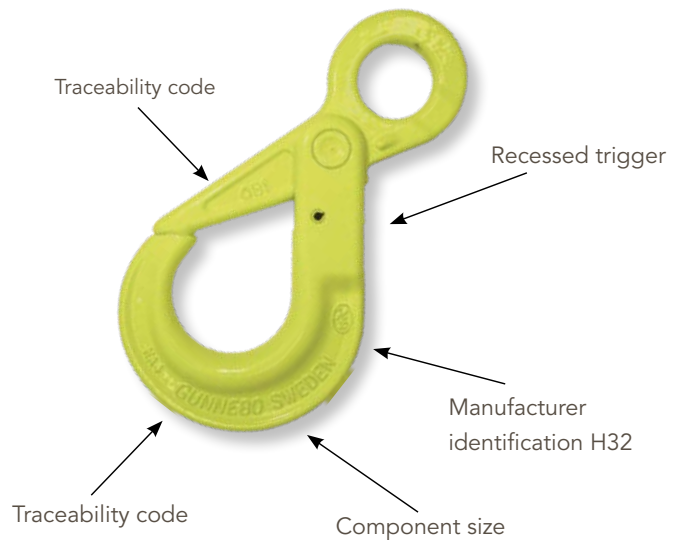
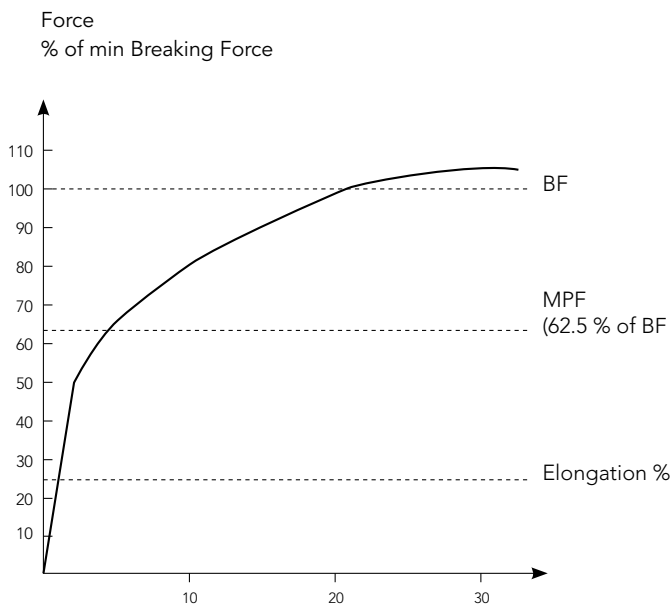



# Working Load Limits - United States

## WLL Ib Grade 10 GrabiQ

Working Load Limits in pounds for chain slings grade 10, according to NACM

Based on A 906/A 906M-2

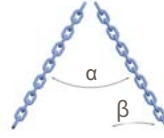
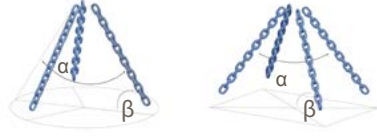
		1-leg	2-leg			3- and 4-leg		
								
			$\beta$ 60°	$\beta$ 45°	$\beta$ 30°	$\beta$ 60°	$\beta$ 45°	$\beta$ 30°
Chain size mm	Chain size inch		$\alpha$ 60°	$\alpha$ 90°	$\alpha$ 120°	$\alpha$ 60°	$\alpha$ 90°	$\alpha$ 120°
6	-	3 300	5 500	4 625	3 300	8 400	6 800	4 850
7	9/32"	4 300	7 400	6 100	4 300	11 200	9 100	6 400
8	5/16"	5 700	9 900	8 100	5 700	14 800	12 100	8 500
10	3/8"	8 800	15 200	12 400	8 800	22 900	18 700	13 200
13	1/2"	15 000	26 000	21 200	15 000	39 000	31 800	22 500
16	5/8"	22 600	39 100	32 000	22 600	58 700	47 900	33 900
20	3/4"	35 300	61 100	49 900	35 300	91 700	74 900	52 950
22	7/8"	42 700	74 000	60 400	42 700	110 900	90 600	64 000
26	1"	59 700	103 100	84 100	59 500	155 600	126 600	89 250
32	1-1/4"	88 160	152 700	124 600	88 160	229 000	186 950	132 200

Note 1: WLL for 2-leg sling and single leg basket slings = 2 x 1-leg WLL x sin of horizontal angle  $\alpha$

Note 2: WLL for 3- and 4-leg sling and 2-leg basket slings = 3 x 1-leg WLL x sin of horizontal angle  $\alpha$

Note 3: WLL based upon equally loaded and disposed sling legs

## WLL Ib Grade 8 Classic

Working Load Limits in pounds for chain slings grade 8, according to NACM

Based on A 906/A 906M-2

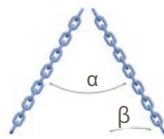
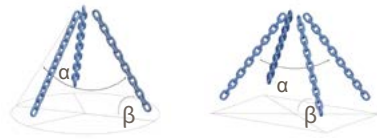
		1-leg	2-leg			3- and 4-leg		
								
			$\beta$ 60°	$\beta$ 45°	$\beta$ 30°	$\beta$ 60°	$\beta$ 45°	$\beta$ 30°
Chain size mm	Chain size inch		$\alpha$ 60°	$\alpha$ 90°	$\alpha$ 120°	$\alpha$ 60°	$\alpha$ 90°	$\alpha$ 120°
6	-	2 450	4 200	3 300	2 425	6 400	5 050	3 525
7	9/32"	3 500	6 100	4 900	3 500	9 100	7 400	5 200
8	5/16"	4 500	7 800	6 400	4 500	11 700	9 500	6 800
10	3/8"	7 100	12 300	10 000	7 100	18 400	15 100	10 600
13	1/2"	12 000	20 800	17 000	12 000	31 200	25 500	18 000
16	5/8"	18 100	31 300	25 600	18 100	47 000	38 400	27 100
20	3/4"	28 300	49 000	40 000	28 300	73 500	60 000	42 400
22	7/8"	34 200	59 200	48 400	34 200	88 900	72 500	51 300
26	1"	47 700	82 600	67 400	47 700	123 900	101 200	71 500
32	1-1/4"	72 300	125 200	102 200	72 300	187 800	153 400	108 400

Note 1: WLL for 2-leg sling and single leg basket slings = 2 x 1-leg WLL x sin of horizontal angle  $\alpha$

Note 2: WLL for 3- and 4-leg sling and 2-leg basket slings = 3 x 1-leg WLL x sin of horizontal angle  $\alpha$

Note 3: WLL based upon equally loaded and disposed sling legs



# Tips for chain sling assembly

## General

1. The reach of the sling is the length measured from the load bearing surface of the master link to the load bearing surface of the hook or lower terminal (as shown in illustrations).
2. A metal ID tag must always be attached to a chain sling, showing serial number, size, reach, Working Load Limit at angle of lift and manufacturer.
3. Each sling manufactured shall have a completed certificate of test provided to user.

## Classic chain slings

4. Single Leg Sling  
If the required measurement falls in the middle of a link, the next link is cut.
5. Double Leg Sling (clevis system)  
Cut chain to length and count the links. You must have an even number of links so hooks hang in the correct plane. Hooks should always point out, as shown in diagram.
6. Triple or Quadruple Leg Sling (clevis system)  
Cut chain to length and count the links. You must have an odd number of links so hooks hang in the correct plane. Hooks should always point out, as shown in diagram. If the measurement falls in the middle of a link, the next link that produce an odd number is cut.

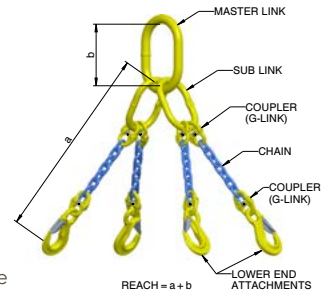

## GrabiQ chain slings

7. It is a common practice, when possible, to keep all hooks in the same plane as the master link. This is easily accomplished on 1, 2, & 4 leg slings. It is not possible with 3-leg GrabiQ slings when single and dual fittings are mixed.
8. It is a common practice, when possible, to attach hooks so that latches point away from the master link.
9. Mixing GrabiQ fittings: Adding two additional chain links to the CL & CLD gives the same effective reach as CG & CGD. The MG & MGD have the same effective reach.
10. Normally, the master link will have a maximum of two connecting links, CG, CGD, CL, or CLD. The maximum number of connecting links that can ever be mounted on a single master link is three, when constructing a double leg basket.
11. A GrabiQ sling can never have more than four independent legs or two basket legs.
12. Attaching CG, CGD, CL, & CLD connectors to MF and MFX Master Links: Insert the connector onto the master link at the engineered flat. C-Connecting links are normally attached to the master link using the Dismountable Connecting Set type CS or the Permanent Connecting Set type CP. Each C-Connector includes one solid retainer pin, 1 larger rolled spring keeper pin and 1 smaller rolled spring keeper pin. When the dismountable connecting set is used the sling can be disassembled for repair. The permanent connecting set cannot be disassembled for repair.
  - a. CS – First install the solid retainer pin. Second drive the smaller rolled spring keeper pin through the hole provided at a right angle to the solid retainer pin. The fit should be very snug.
  - b. CP – First install the solid retainer pin. Second drive the larger rolled spring keeper pin into the same hole, directly behind solid retainer pin. The fit should be very snug.

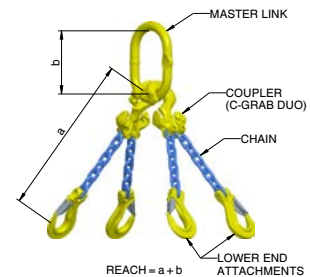

# Lifting Points

Rotating • Ball-bearing • De-centered • Weldable • Screw-on



**GUNNEBO**  
Industries

## Lifting Points

Lifting Points Information	3:2
Rotating Eye Lifting Point - RELP	3:4
Rotating Lifting Point - RLP	3:5
Decentered Lifting Point - DLP	3:6
Ball-bearing Lifting Point - BLP	3:7
Master Link - D	3:8
Weldable Lifting Point - WLP	3:8
Screw-on Lifting Point - SLP	3:8
Eye Lifting Point - ELP	3:8
Spare Parts	3:9 - 3:10

## Technical Information

Instructions for Safe Use	3:11 - 3:12
Working Load Limits	3:13



**WARNING:**  
Failure to read, understand and comply with the instructions, working load limits and specifications in this publication may result in serious injury or damage to property.

# The Lifting Point Family

We offer a wide range of lifting points that will fit most lifting and lashing applications. In our lifting point family you will find a full system, from master link to lifting point.

Choosing the right lifting point for your operation can be tricky, most lifting points can be used for a lot of purposes. But in order to give some guidance, and what we consider best practice, we have created a cross-chart (as seen on next page) to be used as indication to which lifting point that might be best suited for your specific purpose.

## Rotating Eye Lifting Point - RELP

The RELP is a compact and robust lifting point, ideal for top-mounting and when it is important to have quick and easy on-hooking. The lifting point is easy to assemble/disassemble with a standard allen key. On the bolt itself information such as the working load limit, mounting torque and manufacturing ID is stamped, so it is always available for the operator.

The RELP will automatically adjust to the loading direction which decreases the risk to load it incorrectly and endangering the lifting operation. For sensitive load surfaces the RELP is ideal, as the connecting sling hook will be positioned mainly parallel to the load surface, thus completely avoiding the hook causing damage on impact on the load. CE marked.



## Rotating Lifting Point - RLP

The RLP has an easily dismantlable D-ring to enable assembly of wiresling, master link or hook directly onto the lifting point.

RLP has a hexagon bolt (RFID prepared) to make it easy to disassemble/assemble with a wrench. The bolt is also clearly marked with information such as working load limit, mounting torque and manufacturer ID so it is always available to the operator. The RLP rotates 360° and pivots 180°, making it strong, flexible and reliable. CE marked.



## De-centered Lifting Point - DLP

The design of the DLP allows the link to be folded over the housing when idle, allowing the lifting point to be almost completely stowed away when not in use.

The closed, oblong link is also equipped with a "stay-up"-function for easy on-hooking, (sizes up to M24) especially when there is limited space. This saves both the load from damage due to impacts from the hook, as well as making rigging fast and easy. The DLP is ideal in narrow spaces, such as corners or edge position, as the housing has a compact design.

DLP has a hexagon bolt (RFID prepared) to make it easy to disassemble/assemble with a wrench. The bolt is also clearly marked with information such as working load limit, mounting torque and manufacturer ID so it is always available to the operator. CE marked.



## Ball-bearing Lifting Point - BLP

The BLP is a very versatile lifting point and can safely be used for most applications. The ball-bearings in the BLP allow the load to be rotated during the lift, which is especially good when maintenance is needed on heavy tools and other types of equipment.

If the load surface is sensitive to impacts or scratches, the BLP is a good choice as it builds out from the load which makes it less likely that the lifting equipment will come in contact with it causing damage. The housing (RFID prepared) of the BLP is in-house drop-forged for increased strength and has a hexagon shape for easy mounting and dismounting. The housing is also clearly marked with information such as working load limit, mounting torque and manufacturer ID so it is always available to the operator. CE marked.





	RELP	RLP	DLP	BLP
Tight space	✓		✓	✓
Limited height (effective length)	✓	✓		
Vertical lift	✓	✓		✓
Angular lift		✓	✓	✓
Vertical rotation under load				✓
Tilting under load		✓	✓	✓
Sensitive load surface				✓
Single part lift	✓	✓		✓
Multiple part lift		✓	✓	✓
Integrated combination (hook or link)		✓		
RFID prepared		✓	✓	✓

*This chart is intended to give guidance in choosing the right lifting point for your operation and is not rules for usage. For more advice contact your closest Gunnebo Industries dealer.*

## Rotating Eye Lifting Point RELP

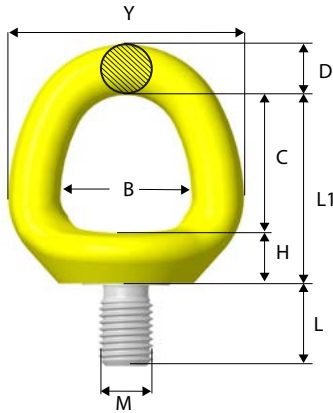

Art. no.	Code	B	C	D	E	H	L	L1	M	Y	Z	Weight lb
Z102408	RELP-M8 x 1.25	1.10	1.10	0.43	1.57	0.55	0.59	1.65	0.31	1.97	1.14	0.44
Z102410	RELP-M10 x 1.5	1.10	1.10	0.43	1.57	0.55	0.59	1.65	0.39	1.97	1.14	0.44
Z102412	RELP-M12 x 1.75	1.26	1.30	0.51	1.81	0.51	0.79	1.85	0.47	2.28	1.50	0.66
Z102416	RELP-M16 x 2	1.54	1.61	0.59	2.09	0.63	0.94	2.24	0.63	2.76	1.57	1.10
Z102420	RELP-M20 x 2.5	1.65	1.69	0.63	2.36	0.71	1.18	2.36	0.79	3.07	1.81	1.54
Z102424	RELP-M24 x 3	1.97	2.01	0.75	2.68	0.79	1.42	2.80	0.94	3.46	1.73	2.43
Z102430	RELP-M30 x 3.5	2.36	2.44	1.02	3.35	1.10	1.77	3.54	1.18	4.41	2.52	5.29
Z102436	RELP-M36 x 4	2.83	2.83	1.26	3.82	1.26	2.13	4.09	1.42	5.35	2.91	9.04
Z102442	RELP-M42 x 4.5	3.23	3.23	1.50	4.72	1.46	2.48	4.69	1.65	6.22	3.58	14.77
Z102448	RELP-M48 x 5	3.70	3.78	1.69	5.59	1.54	2.83	5.31	1.89	7.09	4.02	21.83

Bolt according to: ISO 898-1 Class 10.9

## RELP with UNC thread



Art. no.	Code	B	C	D	E	H	L	L1	Y	Z	M	Weight lb
Z102508	RELP 5/16"-18 UNC	1.10	1.10	0.43	1.57	0.55	0.59	1.65	1.97	1.14	5/16"	0.44
Z102510	RELP 3/8"-16 UNC	1.10	1.10	0.43	1.57	0.55	0.59	1.65	1.97	1.14	3/8"	0.44
Z102512	RELP 1/2"-13 UNC	1.26	1.30	0.51	1.81	0.51	0.79	1.85	2.28	1.50	1/2"	0.66
Z102516	RELP 5/8"-11 UNC	1.54	1.61	0.59	2.09	0.63	0.94	2.24	2.76	1.57	5/8"	1.10
Z102520	RELP 3/4"-10 UNC	1.65	1.69	0.63	2.36	0.71	1.18	2.36	3.07	1.81	3/4"	1.54
Z102521	RELP 7/8"-9 UNC	1.65	1.69	0.63	2.36	0.71	1.18	2.36	3.07	1.81	7/8"	1.54
Z102524	RELP 1"-8 UNC	1.97	2.01	0.75	2.68	0.79	1.42	2.80	3.46	1.73	1"	2.43
Z102530	RELP 1 1/4"-7 UNC	2.36	2.44	1.02	3.35	1.10	1.77	3.54	4.41	2.52	1 1/4"	5.29
Z102536	RELP 1 1/2"-6 UNC	2.83	2.83	1.26	3.82	1.26	2.13	4.09	5.35	2.91	1 1/2"	9.04
Z102542	RELP 1 3/4"-5 UNC	3.23	3.23	1.50	4.72	1.46	2.48	4.69	6.22	3.58	1 3/4"	14.99
Z102548	RELP 2"-4.5 UNC	3.70	3.78	1.69	5.59	1.54	2.83	5.31	7.09	4.02	2"	22.05

Bolt according to: ISO 898-1 Class 10.9

## Working Load Limits\* - RELP

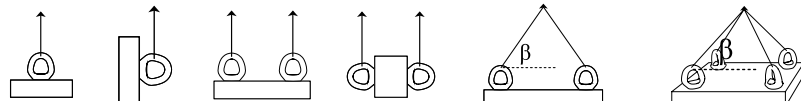
Symmetric Load (lb)							Tightening torque	Allen key				
	No. of legs	Angle $\beta$	1	1	2	2			2 symmetric	3 & 4 symmetric		
			0°	90°	0°	90°	45°	30°	45°	30°		
RELP - M8 x 1.25	1543	661	3086	1322	882	661	1322	882	10 Nm	8 mm		
RELP 5/16"-18 UNC	1543	661	3086	1322	882	661	1322	882	7Ft.Lbs	5/16" UNC		
RELP-M10x1,5	2645	1102	5290	2204	1543	1102	2204	1543	15 Nm	8 mm		
RELP 3/8"-16 UNC	2645	1102	5290	2204	1543	1102	2204	1543	11Ft.Lbs	5/16" UNC		
RELP - M12x1,75	4408	1763	8816	3526	2424	1763	3526	2645	27 Nm	8 mm		
RELP 1/2"-13 UNC	4408	1763	8816	3526	2424	1763	3526	2645	20Ft.Lbs	5/16" UNC		
RELP - M16x2	7714	3306	15428	6612	4628	3306	6832	4849	60 Nm	8 mm		
RELP 5/8"-11 UNC	7714	3306	15428	6612	4628	3306	6832	4849	44Ft.Lbs	5/16" UNC		
RELP - M20x2,5	13444	5290	26889	10579	7273	5290	11020	7934	90 Nm	19 mm		
RELP 3/4"-10 UNC	11020	5069	22040	10138	6832	5069	10579	7494	66Ft.Lbs	3/4" UNC		
RELP 7/8"-9 UNC	13444	6392	26889	12783	8948	6392	13422	9477	66Ft.Lbs	3/4" UNC		
RELP - M24x3	17852	7273	35705	14546	10138	7273	15208	10800	135 Nm	19 mm		
RELP 1"-8 UNC	17852	7273	35705	14546	10138	7273	15208	10800	100Ft.Lbs	3/4" UNC		
RELP - M30x3,5	26668	10138	53337	20277	14106	10138	21158	15208	270 Nm	19 mm		
RELP 1 1/4"-7 UNC	26668	10138	53337	20277	14106	10138	21158	15208	200Ft.Lbs	3/4" UNC		
RELP - M36x4	35484	15648	70969	31297	21820	15648	32840	23362	320 Nm	19 mm		
RELP 1 1/2"-6 UNC	35484	15648	70969	31297	21820	15648	32840	23362	236Ft.Lbs	3/4" UNC		
RELP - M42x4,5	52896	20056	105792	40113	28079	20056	42118	29974	600 Nm	19 mm		
RELP 1 3/4"-5 UNC	52896	20056	105792	40113	28079	20056	42118	29974	440Ft.Lbs	3/4" UNC		
RELP - M48x5	70528	26668	141056	53337	37336	26668	56004	39892	800 Nm	19 mm		
RELP 2"-4,5 UNC	70528	26668	141056	53337	37336	26668	56004	39892	590Ft.Lbs	3/4" UNC		

## Rotating Lifting Point RLP



Art. no. Standard bolt length	L	Art.no. Long bolt length**	L2	Code	B	C	D	L1	M	X	Y	Z	Weight lb***
Z101708	0.63	Z1017080L	3.98	RLP-M8 x 1.25	1.65	1.38	0.47	2.44	0.31	1.06	2.52	Ø1.57	0.66
Z101710	0.63	Z1017100L	3.98	RLP-M10 x 1.5	1.65	1.38	0.47	2.44	0.39	1.06	2.52	Ø1.57	0.66
Z101712	0.98	Z1017120L	4.72	RLP-M12 x 1.75	2.24	1.81	0.75	3.46	0.47	1.65	3.58	Ø2.13	2.20
Z101716	0.98	Z1017160L	6.30	RLP-M16 x 2	2.24	1.81	0.75	3.46	0.63	1.65	3.58	Ø2.13	2.20
Z101720	1.42	Z1017200L	7.87	RLP-M20 x 2.5	3.27	2.17	1.10	4.33	0.79	2.17	5.24	Ø3.15	6.39
Z101724	1.42	Z1017240L	9.45	RLP-M24 x 3	3.27	2.17	1.10	4.33	0.94	2.17	5.24	Ø3.15	6.39
Z101730	2.28	Z1017300L	11.81	RLP-M30 x 3.5	4.49	2.76	1.34	5.83	1.18	3.07	7.17	Ø4.37	15.65
Z101736	2.28	Z1017360L	11.81	RLP-M36 x 4	4.49	2.76	1.34	5.83	1.42	3.07	7.17	Ø4.37	16.09
Z101742	3.19	Z1017420L	11.85	RLP-M42 x 4.5	5.87	3.58	1.57	7.48	1.65	3.90	9.02	Ø5.59	31.53
Z101748	3.19	Z1017480L	11.85	RLP-M48 x 5	5.87	3.58	1.57	7.48	1.89	3.90	9.02	Ø5.59	31.97

\*\* Long Bolt supplied with nut and washer. \*\*\* Weight is calculated with standard bolt length.  
Bolt, nut and washer according to: ISO 898-1 Class 10.9

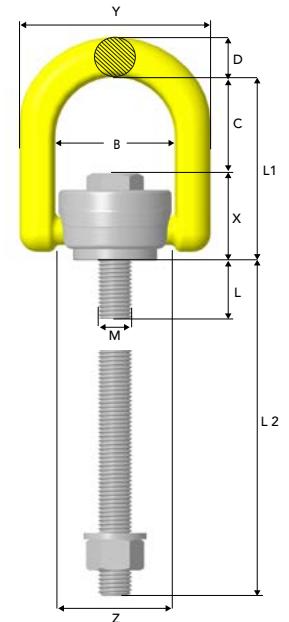

## RLP with UNC thread



Art. no. Standard bolt length	L	Art.no. long bolt length**	L2	Code	B	C	D	L1	X	Y	Z	M	Weight lb***
Z101808	0.63	Z1018080L	3.98	RLP-5/16"-18 UNC	1.65	1.38	0.47	2.44	1.06	2.52	Ø1.57	5/16"	0.66
Z101810	0.63	Z1018100L	3.98	RLP-3/8"-16 UNC	1.65	1.38	0.47	2.44	1.06	2.52	Ø1.57	3/8"	0.66
Z101812	0.98	Z1018120L	4.72	RLP-1/2"-13 UNC	2.24	1.81	0.75	3.46	1.65	3.58	Ø2.13	1/2"	2.20
Z101816	0.98	Z1018160L	6.30	RLP-5/8"-11 UNC	2.24	1.81	0.75	3.46	1.65	3.58	Ø2.13	5/8"	2.20
Z101820	1.42	Z1018200L	7.87	RLP-3/4"-10 UNC	3.27	2.17	1.10	4.33	2.17	5.24	Ø3.15	3/4"	6.39
Z101821	1.42	Z1018210L	7.87	RLP-7/8"-9 UNC	3.27	2.17	1.10	4.33	2.17	5.24	Ø3.15	7/8"	6.39
Z101824	1.42	Z1018240L	9.45	RLP 1"-8 UNC	3.27	2.17	1.10	4.33	2.17	5.24	Ø3.15	1"	6.39
Z101830	2.28	Z1018300L	11.81	RLP 1 1/4"-7 UNC	4.49	2.76	1.34	5.83	3.07	7.17	Ø4.37	1 1/4"	15.65
Z101836	2.28	Z1018360L	11.81	RLP 1 1/2"-6 UNC	4.49	2.76	1.34	5.83	3.07	7.17	Ø4.37	1 1/2"	16.09
Z101842	3.19	Z1018420L	11.85	RLP 1 3/4"-5 UNC	5.87	3.58	1.57	7.48	3.90	9.02	Ø5.59	1 3/4"	31.75
Z101848	3.19	Z1018480L	11.85	RLP 2"-4.5 UNC	5.87	3.58	1.57	7.48	3.90	9.02	Ø5.59	2"	32.41

\*\* Long Bolt supplied with nut and washer. \*\*\* Weight is calculated with standard bolt length.  
Bolt, nut and washer according to: ISO 898-1 Class 10.9

## Working Load Limits\* - RLP

Symmetric Load (lb)									Tightening torque	Spanner size
	No. of legs	1	1	2	2	2 symmetric	3 & 4 sym- metric			
Angle $\beta$	0°	90°	0°	90°	45°	30°	45°	30°		
RLP - M8 x 1.25	1 763	882	3 526	1 763	1 102	882	1 763	1 322	10 Nm	13 mm
RLP 5/16"-18 UNC	1 763	882	3 526	1 763	1 102	882	1 763	1 322	7 Ft.lb	1/2"
RLP - M10 x 1.5	2 645	1 543	5 290	3 086	1 984	1 543	3 086	2 204	15 Nm	13 mm
RLP 3/8"-16 UNC	2 645	1 433	5 290	2 865	1 984	1 322	2 865	1 984	11 Ft.lb	1/2"
RLP - M12 x 1.75	4 408	2 645	8 816	5 290	3 526	2 645	5 510	3 967	27 Nm	24 mm
RLP 1/2"-13 UNC	4 408	2 645	8 816	5 290	3 526	2 645	5 510	3 967	20 Ft.lb	15/16"
RLP - M16 x 2	7 053	4 408	14 106	8 816	6 171	4 408	9 257	6 612	60 Nm	24 mm
RLP 5/8"-11 UNC	7 053	4 408	14 106	8 816	6 171	4 408	9 257	6 612	44 Ft.lb	15/16"
RLP - M20 x 2.5	12 342	6 171	24 685	12 342	8 596	6 171	12 783	9 257	90 Nm	32 mm
RLP 3/4"-10 UNC	11 020	5 510	22 040	11 020	7 714	5 510	11 461	8 155	66 Ft.lb	1 5/16"
RLP 7/8"-9 UNC	12 342	6 171	24 685	12 342	8 596	6 171	12 783	9 257	66 Ft.lb	1 5/16"
RLP - M24 x 3	17 632	10 138	35 264	20 277	14 106	10 138	21 158	15 208	135 Nm	32 mm
RLP 1"-8 UNC	17 632	10 138	35 264	20 277	14 106	10 138	21 158	15 208	100 Ft.lb	1 5/16"
RLP - M30 x 3.5	26 448	13 224	52 896	26 448	18 514	13 224	27 770	19 836	270 Nm	55 mm
RLP 1 1/4"-7 UNC	26 448	13 224	52 896	26 448	18 514	13 224	27 770	19 836	200 Ft.lb	2 1/4"
RLP - M36 x 4	30 856	17 632	61 712	35 264	24 685	17 632	37 027	26 448	320 Nm	55 mm
RLP 1 1/2"-6 UNC	30 856	17 632	61 712	35 264	24 685	17 632	37 027	26 448	236 Ft.lb	2 1/4"
RLP - M42 x 4.5	35 264	30 856	70 528	61 712	43 198	30 856	64 798	46 284	600 Nm	75 mm
RLP 1 3/4"-5 UNC	35 264	30 856	70 528	61 712	43 198	30 856	64 798	46 284	440 Ft.lb	3"
RLP - M48 x 5	44 080	35 264	88 160	70 528	49 370	35 264	74 054	52 896	800 Nm	75 mm
RLP 2"-4.5 UNC	44 080	35 264	88 160	70 528	49 370	35 264	74 054	52 896	590 Ft.lb	3"



Disassembly of the RLP is made easy by just folding the D-ring forward and push down.

## De-centered Lifting Point DLP

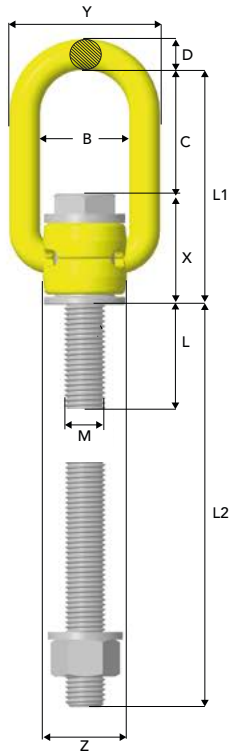

Art. no. Standard bolt length	L	Art.no. Long bolt length**	L2	Code	B	C	D	E	F	G	L1	M	X	Y	Z	Weight lb***
Z102208	0.51	Z1022080L	3.84	DLP-M8 x 1.25	1.38	1.89	0.39	1.54	0.55	0.39	3.07	0.31	1.18	2.17	1.02	0.66
Z102210	0.51	Z1022100L	3.84	DLP -M10 x 1.5	1.38	1.89	0.39	1.54	0.55	0.39	3.07	0.39	1.18	2.17	1.02	0.66
Z102212	0.91	Z1022120L	4.65	DLP -M12 x 1.75	1.38	1.89	0.47	2.01	0.79	0.55	3.58	0.47	1.73	2.32	1.26	1.10
Z102216	0.91	Z1022160L	6.22	DLP-M16 x 2	1.38	1.89	0.47	2.01	0.79	0.55	3.58	0.63	1.73	2.32	1.26	1.10
Z102220	1.34	Z1022200L	7.80	DLP-M20 x 2.5	2.13	3.46	0.71	2.80	1.10	0.71	5.71	0.79	2.28	3.54	1.89	3.53
Z102224	1.34	Z1022240L	9.37	DLP-M24 x 3	2.13	3.46	0.71	2.80	1.10	0.71	5.71	0.94	2.28	3.54	1.89	3.75
Z102230	2.09	Z1022300L	11.61	DLP-M30 x 3.5	3.23	3.70	1.02	4.09	1.54	1.06	7.17	1.18	3.46	4.80	2.95	11.02
Z102236	2.09	Z1022360L	11.61	DLP-M36 x 4	3.23	3.70	1.02	4.09	1.54	1.06	7.17	1.42	3.46	4.80	2.95	11.46
Z102242	2.87	Z1022420L	11.54	DLP-M42 x 4.5	3.94	4.09	1.42	5.35	2.13	1.34	8.50	1.65	4.45	6.14	4.33	25.57
Z102248	2.87	Z1022480L	11.54	DLP-M48 x 5	3.94	4.06	1.42	5.35	2.13	1.34	8.50	1.89	4.45	6.14	4.33	26.24

\*\* Long Bolt supplied with nut and washer. \*\*\* Weight is calculated with standard bolt length. Bolt, nut and washer according to: ISO 898-1 Class 10.9

## DLP with UNC thread



Art. no. Standard bolt length	L	Art.no. Long bolt length**	L2	Code	B	C	D	E	F	G	L1	X	Y	Z	M	Weight lb***
Z102308	0.51	Z1023080L	3.84	DLP-5/16"-18 UNC	1.38	1.89	0.39	1.54	0.55	0.39	3.07	1.18	2.17	1.02	5/16"	0.66
Z102310	0.51	Z1023100L	3.84	DLP-3/8"-16 UNC	1.38	1.89	0.39	1.54	0.55	0.39	3.07	1.18	2.17	1.02	3/8"	0.66
Z102312	0.91	Z1023120L	4.65	DLP-1/2"-13 UNC	1.38	1.89	0.47	2.01	0.79	0.55	3.58	1.73	2.32	1.26	1/2"	1.10
Z102316	0.91	Z1023160L	6.22	DLP-5/8"-11 UNC	1.38	1.89	0.47	2.01	0.79	0.55	3.58	1.73	2.32	1.26	5/8"	1.10
Z102320	1.34	Z1023200L	7.80	DLP-3/4"-10 UNC	2.13	3.46	0.71	2.80	1.10	0.71	5.71	2.28	3.54	1.89	3/4"	3.53
Z102321	1.34	Z1023210L	7.80	DLP-7/8"-9 UNC	2.13	3.46	0.71	2.80	1.10	0.71	5.71	2.28	3.54	1.89	7/8"	3.53
Z102324	1.34	Z1023240L	9.37	DLP-1"-8 UNC	2.13	3.46	0.71	2.80	1.10	0.71	5.71	2.28	3.54	1.89	1"	3.75
Z102330	2.09	Z1023300L	11.61	DLP-1 1/4"-7 UNC	3.23	3.70	1.02	4.09	1.54	1.06	7.17	3.46	4.80	2.95	1 1/4"	12.13
Z102336	2.09	Z1023360L	11.61	DLP-1 1/2"-6 UNC	3.23	3.70	1.02	4.09	1.54	1.06	7.17	3.46	4.80	2.95	1 1/2"	12.57
Z102342	2.87	Z1023420L	11.54	DLP-1 3/4"-5 UNC	3.94	4.06	1.42	5.35	2.13	1.34	8.50	4.45	6.14	4.33	1 3/4"	25.79
Z102348	2.87	Z1023480L	11.54	DLP-2"-4.5 UNC	3.94	4.06	1.42	5.35	2.13	1.34	8.50	4.45	6.14	4.33	2"	26.68

\*\* Long Bolt supplied with nut and washer. \*\*\* Weight is calculated with standard bolt length. Bolt, nut and washer according to: ISO 898-1 Class 10.9

## Working Load Limits\* - DLP

Symmetric Load (lb)

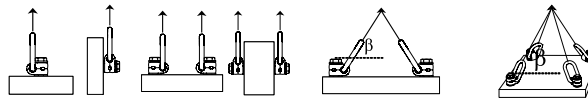

	No. of legs		2 symmetric		3 & 4 symmetric		Tightening torque	Spanner size	
	Angle β	0°-90°	0°-90°	45°	30°	45°			30°
DLP-M8		771	1 543	1 102	771	1 543	1 102	10 Nm	13 mm
DLP-5/16"-18 UNC		771	1 543	1 102	771	1 543	1 102	7Ft.lb	1/2"
DLP -M10		1 433	2 865	1 984	1 433	3 086	2 204	15 Nm	13 mm
DLP-3/8"-16 UNC		1 322	2 645	1 763	1 322	2 865	2 204	11Ft.lb	1/2"
DLP -M12		2 204	4 408	3 086	2 204	4 628	3 306	27 Nm	24 mm
DLP-1/2"-13 UNC		2 204	4 408	3 086	2 204	4 628	3 306	20Ft.lb	15/16"
DLP-M16		3 967	7 934	5 510	3 967	8 155	5 951	60 Nm	24 mm
DLP-5/8"-11 UNC		3 526	7 053	4 849	3 526	7 273	5 290	44Ft.lb	15/16"
DLP - M20x2.5		5 730	11 461	7 714	5 730	11 902	8 596	90 Nm	32 mm
DLP 3/4"-10 UNC		4 849	9 698	6 612	4 849	10 138	7 273	66Ft.lb	1 5/16"
DLP 7/8"-9 UNC		5 730	11 461	7 714	5 730	11 902	8 596	66Ft.lb	1 5/16"
DLP - M24x3		9 036	18 073	12 563	9 036	18 954	13 444	135 Nm	32 mm
DLP 1"-8 UNC		9 036	18 073	12 563	9 036	18 954	13 444	100Ft.lb	1 5/16"
DLP - M30x3.5 (Preliminary)		11 020	22 040	15 428	11 020	23 142	16 530	270 Nm	55 mm
DLP 1 1/4"-7 UNC (Preliminary)		11 020	22 040	15 428	11 020	23 142	16 530	200Ft.lb	2 1/4"
DLP - M36x4 (Preliminary)		15 428	30 856	21 599	15 428	32 399	23 142	320 Nm	55 mm
DLP 1 1/2"-6 UNC (Preliminary)		15 428	30 856	21 599	15 428	32 399	23 142	236Ft.lb	2 1/4"
DLP - M42x4.5 (Preliminary)		33 060	66 120	46 284	33 060	69 426	49 590	600 Nm	75 mm
DLP 1 3/4"-5 UNC (Preliminary)		33 060	66 120	46 284	33 060	69 426	49 590	440Ft.lb	3"
DLP - M48x5 (Preliminary)		44 080	88 160	61 712	44 080	92 568	66 120	800 Nm	75 mm
DLP 2"-4.5 UNC (Preliminary)		44 080	88 160	61 712	44 080	92 568	66 120	590Ft.lb	3"

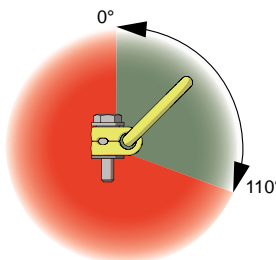

- The DLP can only be loaded from 0° to 110° degrees
- Rotation around screw axis when loaded at 0°-15° is not allowed.



## Ball-bearing Lifting Point BLP



Art. no.	Code	B	C	D	L	L1	M	X	Y	Z	Weight lb
Z102008	BLP-M8 x 1.25	1.38	2.17	0.51	0.63	4.41	0.31	2.24	2.44	Ø1.65	1.32
Z102010	BLP -M10 x 1.5	1.38	2.17	0.51	0.79	4.41	0.39	2.24	2.40	Ø1.65	1.32
Z102012	BLP -M12 x 1.75	1.38	2.17	0.51	0.94	4.41	0.47	2.24	2.40	Ø1.65	1.32
Z102016	BLP-M16 x 2	1.38	2.17	0.51	1.18	4.41	0.63	2.24	2.40	Ø1.65	1.32
Z102020	BLP-M20 x 2.5	1.34	2.24	0.67	1.18	5.20	0.79	2.95	2.64	Ø2.32	2.87
Z102024	BLP-M24 x 3	1.97	2.76	0.67	1.42	5.71	0.94	2.95	3.31	Ø2.32	3.31
Z102030	BLP-M30 x 3.5	2.13	3.78	0.87	1.77	4.02	1.18	4.17	3.90	Ø2.91	7.50
Z102036	BLP-M36 x 4	2.13	3.78	0.87	2.13	4.02	1.42	4.17	3.90	Ø2.91	7.72
Z102042	BLP-M42 x 4.5	2.76	4.72	1.10	2.48	9.53	1.65	4.80	5.00	Ø3.66	14.33
Z102048	BLP-M48 x 5	2.76	4.72	1.10	2.83	9.53	1.89	4.80	5.00	Ø3.66	14.99

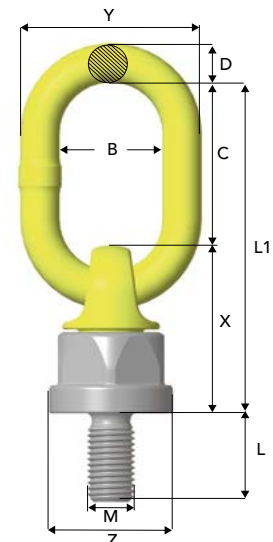

## BLP with UNC thread



Art. no.	Code	B	C	D	L	L1	X	Y	Z	M	Weight lb
Z102108	BLP-5/16"-18 UNC	1.38	2.17	0.51	0.63	4.41	2.24	2.40	Ø1.65	5/16"	1.32
Z102110	BLP-3/8"-16 UNC	1.38	2.17	0.51	0.79	4.41	2.24	2.40	Ø1.65	3/8"	1.32
Z102112	BLP-1/2"-13 UNC	1.38	2.17	0.51	0.94	4.41	2.24	2.40	Ø1.65	1/2"	1.32
Z102116	BLP-5/8"-11 UNC	1.38	2.17	0.51	1.18	4.41	2.24	2.40	Ø1.65	5/8"	1.32
Z102120	BLP-3/4"-10 UNC	1.34	2.24	0.67	1.18	5.20	2.95	2.64	Ø2.32	3/4"	2.87
Z102121	BLP-7/8"-9 UNC	1.34	2.24	0.67	1.18	5.20	2.95	2.64	Ø2.32	7/8"	2.87
Z102124	BLP-1"-8 UNC	1.97	2.76	0.67	1.50	5.71	2.95	3.31	Ø2.32	1"	3.31
Z102130	BLP-1 1/4"-7 UNC	2.13	3.78	0.87	1.89	7.95	4.17	3.90	Ø2.91	1 1/4"	7.50
Z102136	BLP-1 1/2"-6 UNC	2.13	3.78	0.87	2.24	7.95	4.17	3.90	Ø2.91	1 1/2"	7.94
Z102142	BLP-1 3/4"-5 UNC	2.76	4.72	1.10	2.64	9.53	4.80	5.00	Ø3.66	1 3/4"	14.55
Z102148	BLP-2"-4.5 UNC	2.76	4.72	1.10	2.99	9.53	4.80	5.00	Ø3.66	2"	15.43

## Working Load Limits\* - BLP

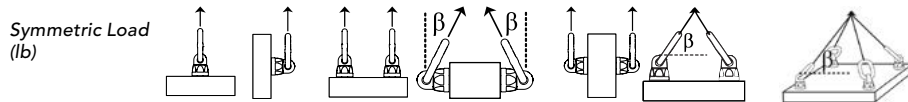

	No. of legs				2 symmetric		3 & 4 symmetric		Tightening torque	Spanner size
	1	1	2	2	30°	45°	45°	30°		
Angle β	0°*	90°	0°	90°						
BLP -M8x1.25	1 322	661	2 645	1 322	661	882	882	992	10 Nm	36 mm
BLP 5/16"-18 UNC	1 322	661	2 645	1 322	661	882	882	992	7Ft.Lb	1 1/2" UNC
BLP -M10x1.5	2 204	1 102	4 408	2 204	1 102	1 543	1 543	1 653	15 Nm	36 mm
BLP 3/8"-16 UNC	1 763	882	3 526	1 763	882	1 102	1 102	1 322	11Ft.Lb	1 1/2" UNC
BLP -M12x1.75	3 306	1 653	6 612	3 306	1 653	2 424	2 424	2 424	27 Nm	36 mm
BLP 1/2"-13 UNC	3 306	1 653	6 612	3 306	1 653	2 424	2 424	2 424	20Ft.Lb	1 1/2" UNC
BLP -M16x2	6 612	3 306	13 224	6 612	3 306	4 628	4 628	4 849	60 Nm	36 mm
BLP 5/8"-11 UNC	6 612	3 306	13 224	6 612	3 306	4 628	4 628	4 849	44Ft.Lb	1 1/2" UNC
BLP -M20x2.5	11 020	5 510	22 040	11 020	5 510	7 714	7 714	8 155	90 Nm	50 mm
BLP 3/4"-10 UNC	9 918	4 959	19 836	9 918	4 959	6 832	6 832	7 273	66Ft.Lb	2" UNC
BLP 7/8"-9 UNC	13 224	6 612	26 448	13 224	6 612	9 257	9 257	9 918	66Ft.Lb	2" UNC
BLP-M24x3	15 428	8 816	30 856	17 632	8 816	12 342	12 342	13 224	135 Nm	50 mm
BLP-1"-8 UNC	15 428	8 816	30 856	17 632	8 816	12 342	12 342	13 224	100Ft.Lb	2" UNC
BLP-M30x3.5	26 448	13 224	52 896	26 448	13 224	18 514	18 514	19 836	270 Nm	65 mm
BLP-1 1/4"-7 UNC	26 448	13 224	52 896	26 448	13 224	18 514	18 514	19 836	200Ft.Lb	2 5/8" UNC
BLP-M36x4	30 856	17 632	61 712	35 264	17 632	24 685	24 685	26 448	320 Nm	65 mm
BLP-1 1/2"-6 UNC	30 856	17 632	61 712	35 264	17 632	24 685	24 685	26 448	236Ft.Lb	2 5/8" UNC
BLP-M42x4.5	35 264	22 040	70 528	44 080	22 040	30 856	30 856	33 060	600 Nm	85 mm
BLP-1 3/4"-5 UNC	35 264	22 040	70 528	44 080	22 040	30 856	30 856	33 060	440Ft.Lb	3 1/8" UNC
BLP-M48x5	39 672	28 652	79 344	57 304	28 652	40 113	40 113	42 978	800 Nm	85 mm
BLP-2"-4.5 UNC	39 672	28 652	79 344	57 304	28 652	40 113	40 113	42 978	590Ft.Lb	3 1/8" UNC

\* provided only axial loading takes place, ie no bending force applied in the direction of the thread.

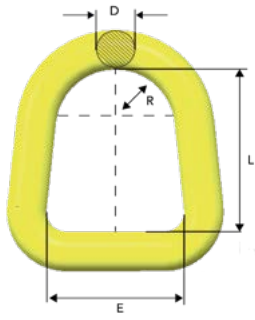

## Master Link D

CE

Art. no.	Code	WLL lb*	E	D	L	R	Weight lb
Z7008771	D-14-10	5 510	2.17	0.55	2.56	0.94	0.88
Z7008781	D-17-10	8 800	2.52	0.67	2.44	1.14	1.10
Z7008801	D-22-10	15 428	2.99	0.87	3.54	1.30	2.20
Z7008791	D-27-10	22 040	3.35	1.06	3.86	1.50	4.19
Z7008792	D-32-10	35 300	4.49	1.26	5.47	1.97	7.72

The load bearing width must be at least 0.5 x E.

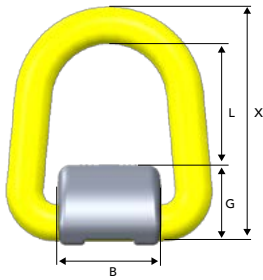

## Weldable Lifting Point WLP

CE

Art. no.	Code	WLL lb*	B	G	L	X	Weight lb
Z7009001	WLP-2.5T	5 510	1.97	1.06	2.09	3.74	1.10
Z7009011	WLP-4T	8 800	2.28	1.34	1.89	3.82	1.76
Z7009021	WLP-7T	15 428	2.52	1.61	2.87	5.31	3.97
Z7009031	WLP-10T	22 040	2.56	2.05	2.87	5.98	7.50
Z7009041	WLP-16T	35 300	3.54	2.60	4.13	7.99	14.77

Supplied with spring for stay up function.  
Master Link measurements, see Master Link D above.  
Working Load Limits on page 3:13.

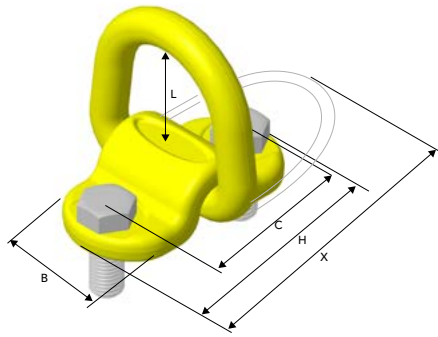

## Screw-on Lifting Point SLP

CE

Art. no.	Code	WLL lb*	B	C	H	L	M (metric thread)	X	Bolt protrusion	Weight lb
Z7009881	SLP-1T	2 204	1.97	2.83	3.86	2.13	M14	5.47	25	1.76
Z7009871	SLP-3T	6 612	2.28	3.31	4.49	1.93	M16	5.67	28	2.87
Z7009861	SLP-5T	11 020	2.52	4.57	6.30	2.80	M20	7.99	34	5.73

Supplied with bolt and spring for stay up function.  
Bolt according to: ISO 898-1 Class 10.9.  
Master Link measurements, see Master Link D above.  
Working Load Limits on page 3:13.

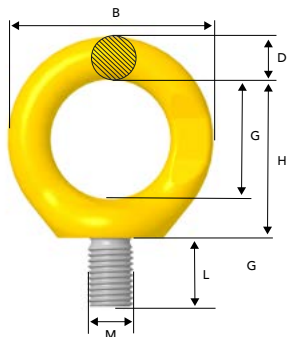

## Eye Lifting Point ELP

Art. no.	Code	WLL		B	D	G	H	L	M	Weight lb
		metric tonnes*	pounds							
Z100434	ELP-16-8	1.0**	2 204	2.83	0.63	1.65	2.17	0.94	M16	0.88
Z100435	ELP-20-8	1.5**	3 306	2.83	0.63	1.65	2.28	1.18	M20	0.88
Z100436	ELP-24-8	2.0**	4 500	3.46	0.75	1.89	2.72	1.42	M24	1.98
Z100437	ELP-30-8	3.0**	6 612	4.17	0.87	2.36	3.31	1.77	M30	3.09

\*\* In case of 1-leg application where loading is limited to straight loading in the direction of thread (no bending force) it is possible to use ELP with four times higher WLL. Note! Threaded depths need to be at least 1xM for steel, 1.25xM for cast iron and 2xM for aluminum alloy.  
Working Load Limits on page 3:13.

# Spare Parts

Standard length bolt and long bolt for RLP and DLP are available as spare parts.

## RDRLP - Metric

Standard length bolt incl. locking ring

Art. no.	Code
Z1017081	RDRLP-M8x1,25
Z1017101	RDRLP-M10x1,5
Z1017121	RDRLP-M12x1,75
Z1017161	RDRLP-M16x2
Z1017201	RDRLP-M20x2,5
Z1017241	RDRLP-M24x3
Z1017301	RDRLP-M30x3,5
Z1017361	RDRLP-M36x4
Z1017421	RDRLP-M42x4,5
Z1017481	RDRLP-M48x5



## RDRLP - Metric

Long bolt incl. nut, locking ring and washer

Art. no.	Code
Z10170801L	RDRLP-M8 LB
Z10171001L	RDRLP-M10 LB
Z10171201L	RDRLP-M12 LB
Z10171601L	RDRLP-M16 LB
Z10172001L	RDRLP-M20 LB
Z10172401L	RDRLP-M24 LB
Z10173001L	RDRLP-M30 LB
Z10173601L	RDRLP-M36 LB
Z10174201L	RDRLP-M42 LB
Z10174801L	RDRLP-M48 LB



3

## RDRLP - UNC

Standard length bolt incl. locking ring

Art. no.	Code
Z1018081	RDRLP-UNC 5/16"-18
Z1018101	RDRLP-UNC 3/8"-16
Z1018121	RDRLP-UNC 1/2"-13
Z1018161	RDRLP-UNC 5/8"-11
Z1018201	RDRLP-UNC 3/4"-10
Z1018211	RDRLP-UNC 7/8"-9
Z1018241	RDRLP-UNC 1"-8
Z1018301	RDRLP-UNC 1 1/4"
Z1018361	RDRLP-UNC 1 1/2"
Z1018421	RDRLP-UNC 1 3/4"
Z1018481	RDRLP-UNC 2"



## RDRLP - UNC

Long bolt incl. nut, locking ring and washer

Art. no.	Code
Z10180801L	RDRLP-UNC 5/16" LB
Z10181001L	RDRLP-UNC 3/8" LB
Z10181201L	RDRLP-UNC 1/2" LB
Z10181601L	RDRLP-UNC 5/8" LB
Z10182001L	RDRLP-UNC 3/4" LB
Z10182101L	RDRLP-UNC 7/8" LB
Z10182401L	RDRLP-UNC 1" LB
Z10183001L	RDRLP-UNC 1 1/4" LB
Z10183601L	RDRLP-UNC 1 1/2" LB
Z10184201L	RDRLP-UNC 1 3/4" LB
Z10184801L	RDRLP-UNC 2" LB



## RDDL P - Metric

Standard length bolt incl. locking ring

Art. no.	Code
Z1022081	RDDL P-M8x1,25
Z1022101	RDDL P-M10x1,5
Z1022121	RDDL P-M12x1,75
Z1022161	RDDL P-M16x2
Z1022201	RDDL P-M20x2,5
Z1022241	RDDL P-M24x3
Z1022301	RDDL P-M30
Z1022361	RDDL P-M36
Z1022421	RDDL P-M42
Z1022481	RDDL P-M48



## RDDL P - Metric

Long bolt incl. nut, locking ring and washer

Art. no.	Code
Z10220801L	RDDL P M8 LB
Z10221001L	RDDL P M10 LB
Z10221201L	RDDL P M12 LB
Z10221601L	RDDL P M16 LB
Z10222001L	RDDL P M20 LB
Z10222401L	RDDL P M24 LB
Z10223001L	RDDL P M30 LB
Z10223601L	RDDL P M36 LB
Z10224201L	RDDL P M42 LB
Z10224801L	RDDL P M48 LB



## RDDL - UNC

Standard length bolt incl. locking ring

Art. no.	Code
Z1023081	RDDL UNC 5/16"
Z1023101	RDDL UNC 3/8"
Z1023121	RDDL UNC 1/2"
Z1023161	RDDL -UNC 5/8"
Z1023201	RDDL -UNC 3/4"
Z1023211	RDDL -UNC 7/8"
Z1023241	RDDL -UNC 1"
Z1023301	RDDL -UNC 1 1/4"
Z1023361	RDDL UNC 1 1/2"
Z1023421	RDDL -UNC 1 3/4"
Z1023481	RDDL -UNC 2"



## RDDL - UNC

Long bolt incl. nut, locking ring and washer

Art. no.	Code
Z10230801L	RDDL UNC 5/16" LB
Z10231001L	RDDL UNC 3/8" LB
Z10231201L	RDDL UNC 1/2" LB
Z10231601L	RDDL UNC 5/8" LB
Z10232001L	RDDL UNC 3/4" LB
Z10232101L	RDDL UNC 7/8" LB
Z10232401L	RDDL UNC 1" LB
Z10233001L	RDDL UNC 1 1/4" LB
Z10233601L	RDDL UNC 1 1/2" LB
Z10234201L	RDDL UNC 1 3/4" LB
Z10234801L	RDDL UNC 2" LB

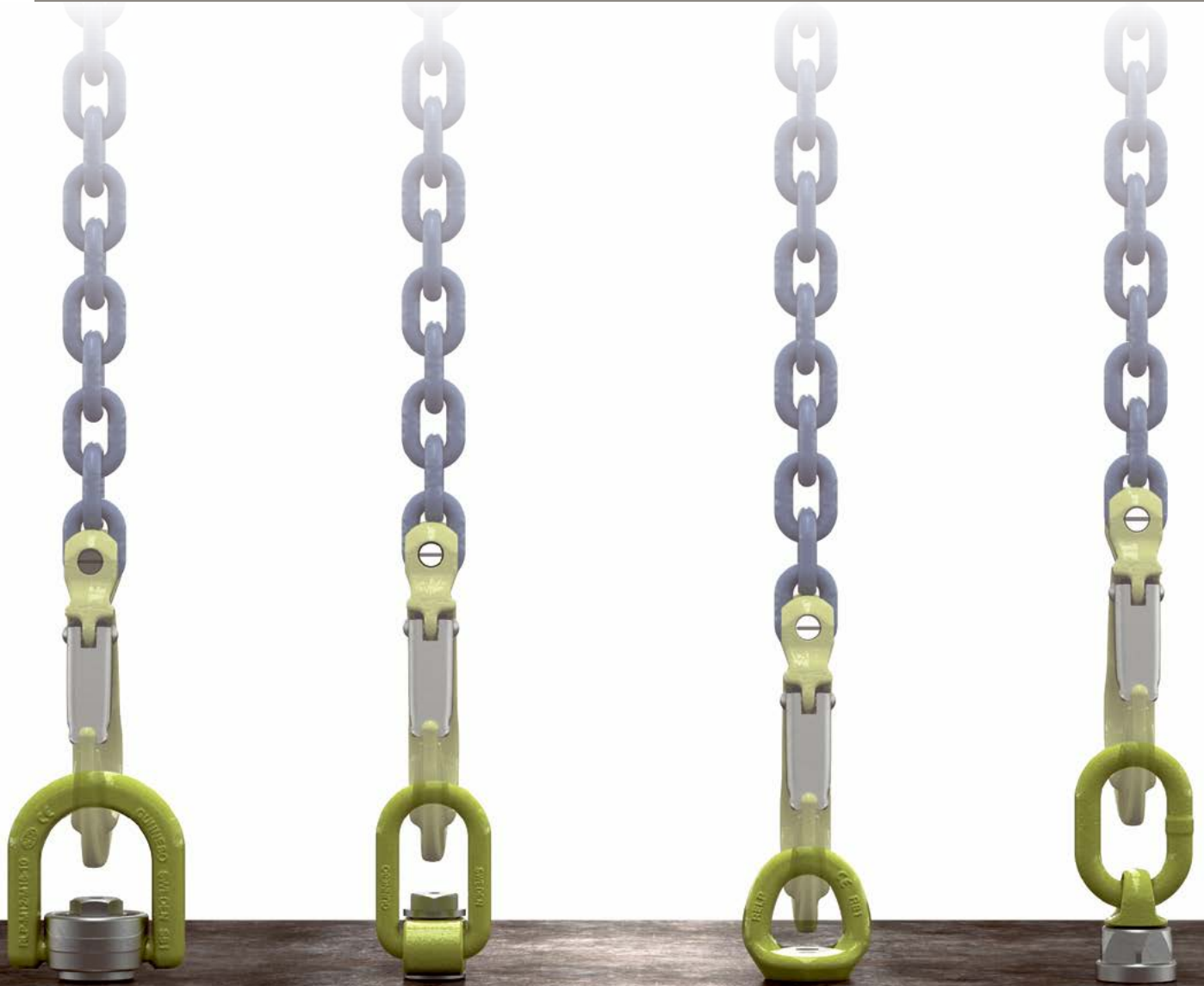

# Technical Information

The following information aims to give advice and explain the most common questions in order to ensure safe and proper use of lifting points. This technical information refers to RELP, RLP, DLP and BLP unless other is stated. Always refer to the user instructions of the specific model of lifting point before use. It is of the most importance that this information is known to the user and in accordance with the Machinery Directive 2006/42/EC this information must be delivered to the customer. See website or user instructions for assembly instructions. Meets listed current specifications and standards at time of publication of this catalogue.

## General Advice

Reference should be made to relevant standards and other statutory regulations. Inspections must be carried out only by people who possess sufficient knowledge.

Before installation and before every use, visually inspect the lifting points, paying particular attention to any evidence of corrosion, wear, weld cracks or deformations. Please ensure compatibility of bolt thread and tapped hole.

The material construction, to which the lifting point will be attached, should be of adequate strength to withstand forces during lifting without deformation.

Ensure minimum thread depth, see table (d refers to bolt diameter).

Thread depth	Yield limit of base material
1 x d	For steel, yield limit >29 ksi
1.25 x d	For cast iron, yield limit >29 ksi
2.5 x d	Aluminum
	For other metal alloys or base materials consult your Gunnebo Industries distributor.

- If the bolt length needs to be adjusted the bolt should be cut with a cold saw or lathe and temperature kept as low as possible during cutting. After cutting check the shape of the threads nearest the cut with an appropriately sized die (there must not be any burrs).
- The surface facing around the thread hole shall be flat (plane), clear of dirt and smooth to ensure perfect contact with the shoulder surface of the Lifting Point.

## Nut and washer

The nut and washer must be the original equipment supplied from Gunnebo Industries to ensure the correct mechanical properties. No warranty, insurance or liability will be accepted if bolts not supplied by Gunnebo Industries have been used.

## Extreme Environments

The in-service temperature affects the WLL as follows:

### RLP

Temperature (°F)	Reduction of WLL
-40 to +392 °F	0 %
+392 to +572 °F	10 %
+572 to +752 °F	25 %
Temperatures below -40°F or above 752 °F are not allowed.	

### RELP

Temperature (°F)	Reduction of WLL
-40 to +212 °F	0 %
+212 to +392 °F	15 %
+392 to +482 °F	20 %
+482 to +662 °F	25 %
Temperatures below -40 F or above 662 F are not allowed.	

### BLP / DLP

Temperature (°F)	Reduction of WLL
-40 to +392 °F	0 %
Temperatures below -40° F or above 392° F are not allowed.	

## Severe Environments

Lifting points must not be used in alkaline (> pH10) or in acidic condition (< pH6).

Comprehensive and regular examination must be carried out when used in severe or corrosive environments. In uncertain situations consult your Gunnebo Industries distributor.

## Surface Treatment

- Hot dip galvanizing or plating is not allowed outside the control of the manufacturer.
- Acid or Alkaline cleaning is not allowed.

## Protect yourself and others

- Before each use the Lifting Point should be checked for obvious damage or deterioration.
- Know the weight of the load and its center of gravity.
- Ensure the load is ready to move and that no obstacles will obstruct the lifting.
- Check the conformity of the load with the Working Load Limit.
- Prepare the landing site.
- Never overload and avoid shock loading.
- Never use an improper configuration.
- Never use a worn or damaged Lifting Point.
- Do not ever ride on the load.
- Do not ever walk or stand under a suspended load.
- Take into consideration that the load may swing or rotate.
- Watch your feet and fingers while loading/unloading.

## Inspection

Periodic thorough examination must be carried out at least every 12 months or more frequently according to local statutory regulations, type of use and past experience.

- Ensure correct bolt and nut size, quality and length.
- Ensure compatibility of bolt thread and tapped hole – control of the torque.
- The lifting point should be complete.
- The working load limit and manufacturers stamp should be clearly visible.
- Check for deformation of the component parts such as body, load ring and bolt.
- Check for mechanical damage, such as notches, particularly in high stress areas.
- Wear should be no more than 10 % of cross sectional diameter.
- Evidence of corrosion.
- Evidence of cracks.
- Damage to the bolt, nut and/or thread.
- The body of the Lifting Point must be free to rotate.

## Symmetric Loading Conditions

- For three and four leg lifts, the Lifting Points should be arranged symmetrically around the center of gravity and in the same plane if possible.
- The WLL for Gunnebo Industries Lifting Points is based on symmetrical loading.
- The Lifting Point must be positioned on the load in such way that movement is avoided during lifting.
- For single leg lifts, the lifting point should be vertically above the center of gravity of the load.
- For two leg lifts, the Lifting Points must be equidistant to or above the center of gravity of the load.

## Asymmetric Loading Conditions

- For unequally loaded lifts we recommend that the WLL is determined as follows:
- 2-leg slings are calculated as the corresponding 1-leg sling.
- 3 and 4-leg slings are calculated as the as the corresponding 1-leg sling\*

*\*(If 2-legs with full certainty are carrying the major part of the load, the WLL can be calculated as for the corresponding 2-leg sling).*

## WLP - WELDING

Preheat the structure if the temperature is below 32°F; otherwise follow AS 1554 or other suitable national standard.

- Ensure that the WLP cannot move during welding by welding the corners of the welding block.
- Continue the weld around the welding block without interruption in a single operation.
- The nozzle or electrode should be at 45° (see Fig. C), so that the required penetration is obtained. The minimum throat (A) should be maintained.

Product	Min. plate gauge (Rm-181.3 ksi) t <sub>min</sub>	Min. throat thickness
WLP 2.5 T	43"	0.43
WLP 4 T	74"	0.51
WLP 7 T	94"	0.63
WLP 10 T	1.18"	0.71
WLP 16 T	1.57"	0.79

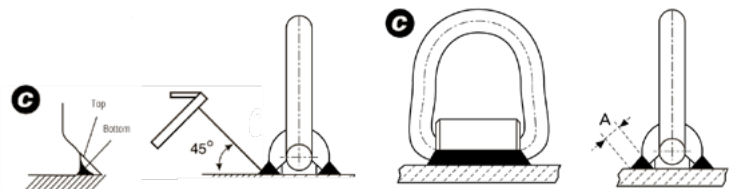

- The weld should not contain cracks or pores.
- Do not cool the weld with water. It should be left to cool naturally.

### Working Load Limits (lb) for WLP

		1-leg	2-leg	3- and 4-leg	
Typ	WLL lb*	$\alpha$ 0-90° $\beta$ 45°	$\alpha$ 90-120° $\beta$ 30°	$\alpha$ 0-90° $\beta$ 45°	$\alpha$ 90-120° $\beta$ 30°
WLP-2.5T	5 510	7 714	5 510	11 681	8 115
WLP-4T	8 816	12 342	8 815	18 514	13 224
WLP-7T	15 428	21 599	15 428	32 619	23 142
WLP-10T	22 040	31 076	22 040	46 725	33 060
WLP-16T	35 300	49 810	35 300	74 716	52 896

3

### Working Load Limits (lb) for SLP

		1-leg	2-leg	3- and 4-leg	
Typ	WLL lb*	$\alpha$ 0-90° $\beta$ 45°	$\alpha$ 90-120° $\beta$ 30°	$\alpha$ 0-90° $\beta$ 45°	$\alpha$ 90-120° $\beta$ 30°
SLP-1T	2 204	3 085	2 204	4 628	3 306
SLP-3T	6 612	9 256	6 612	13 885	9 918
SLP-5T	11 020	15 428	11 020	23 362	16 530

### Working Load Limits (lb) for ELP

		1-leg	2-leg	3- and 4-leg	
Typ	WLL lb*	$\alpha$ 0-90° $\beta$ 45°	$\alpha$ 90-120° $\beta$ 30°	$\alpha$ 0-90° $\beta$ 45°	$\alpha$ 90-120° $\beta$ 30°
ELP-16-8	2 204**	3 085	2 204	4 628	3 306
ELP-20-8	3 306**	4 628	3 306	6 832	4 848
ELP-24-8	4 408**	6 171	4 408	9 256	6 612
ELP-30-8	6 612**	9 256	6 612	13 885	9 918

Note! The above loads apply to normal usage and equally loaded legs. For asymmetric loaded chain slings, the following is recommended:

- A two-legged system is rated as a single-legged system.
- A three- or four-legged system is rated as a two-legged system.

\*\* In case of 1-leg application where loading is limited to straight loading in the direction of thread (no bending force) it is possible to use ELP with four times higher WLL. Note! Threaded depths need to be at least 1xM for steel, 1.25xM for cast iron and 2xM for aluminum alloy.

# Shackles & Rigging Screws

Dee and Bow • Arctic • Aquaculture • ROV  
• Stainless Steel

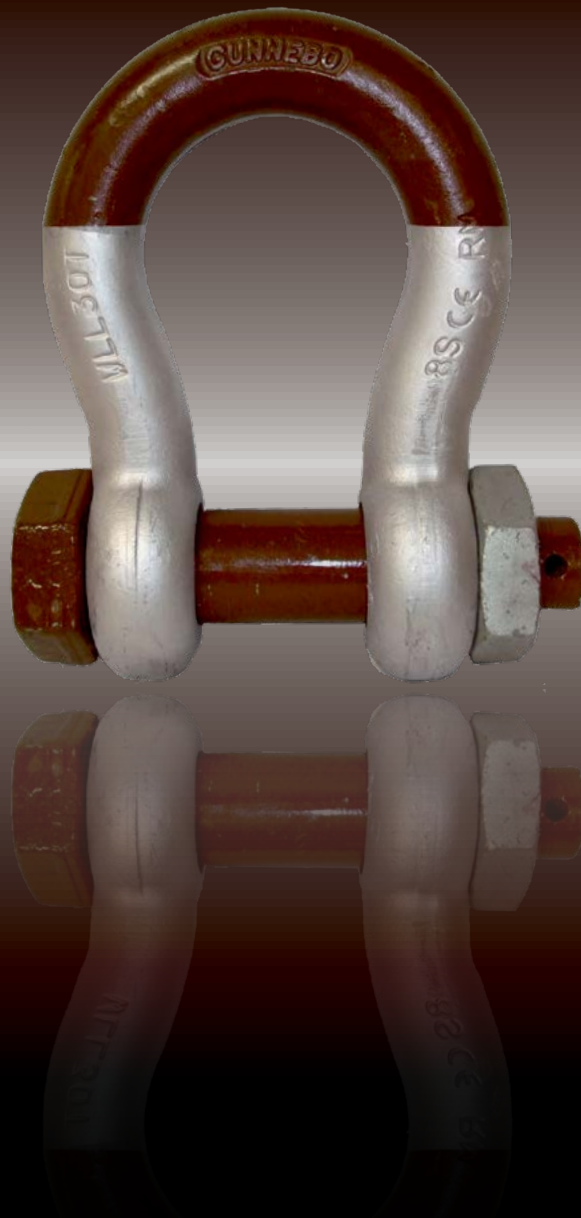

**GUNNEBO**  
Industries



## Shackle

About Gunnebo Industries Shackles	4:2
Shackles, Dee and Bow	4:3 - 4:4
Arctic Shackles	4:5
Super Shackles	4:6
Aquaculture	4:7
Mooring Shackles	4:8
Countersunk Shackles	4:8
Mooring Bolts	4:9
Galvanized Master Link	4:9
ROV Shackles	4:10 - 4:11
Shackles, Stainless Steel	4:12 - 4:13
Shackles, SA	4:13

## Rigging Screw

Rigging Screws, Alloy Steel	4:14
Rigging Screws, Hot Dip Galvanized	4:14

## Technical Information, Shackle

Instructions for Safe Use	4:15
---------------------------	------



**WARNING:**  
Failure to read, understand and comply with the instructions, working load limits and specifications in this publication may result in serious injury or damage to property.

# Feel Confident in Every Situation

Our lifting systems are valued for their long durability and high quality. Whether the working environment is hot or cold, our systems assure lifting operations with high safety and functionality.

Gunnebo Industries shackles are made from a range of steel qualities, including acid proof stainless steel and high grade alloy steel to comply with the most stringent specifications. Our workshops comprise all facilities and systems for the manufacturing and control of a top quality product. This includes tool design, an advanced tool shop, forging, heat treatment, machining, hot dip galvanizing and quality control.

We offer a range of DNV 2.7-1 Type approved lifting shackles for offshore containers, developed for the tough conditions of the offshore industry, where safety must be of the highest priority at all times. The heat treatment of these products ensures the proper ductility and strength to sustain shock loads which may be imposed when the container is lifted from the deck of a vessel.

Furthermore we offer Standard shackles, Super lifting shackles with increased working load limit, ROV shackles, Heavy duty shackles, Wide-Body shackles, Mooring shackles, Stainless Steel shackles etc.

## Make sure you have the original

- High quality shackles acc. EN 13889 and U.S. Fed.Spec RR-C. 271 (grade A and grade B)
- Consistent product quality
- Long experience of shackle production using modern manufacturing methods
- Local availability of expertise from Gunnebo Industries subsidiary or distributors

To ensure you have a genuine Gunnebo Industries Shackle, it should be marked as below:

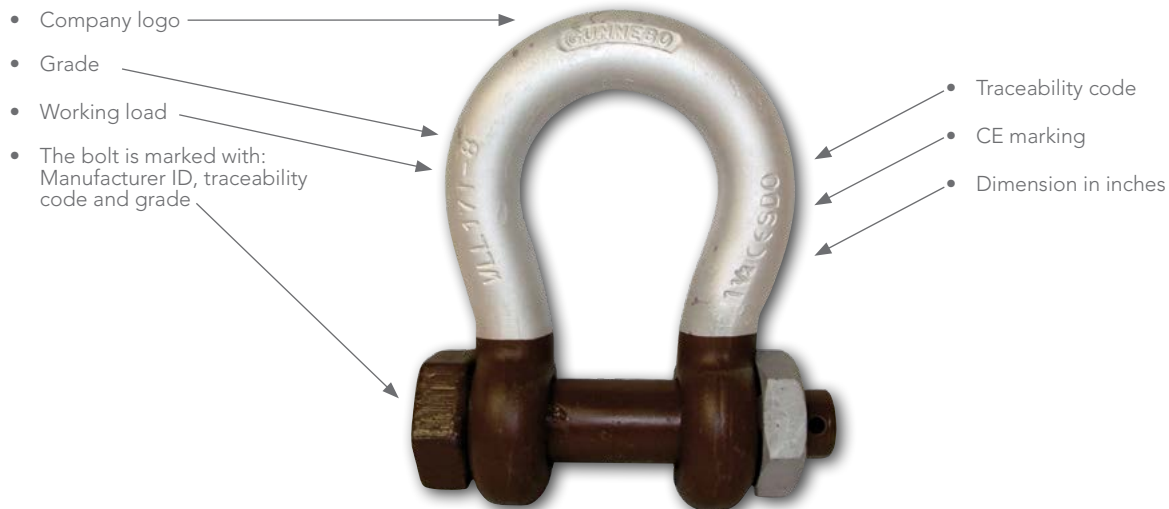

## Dee Shackle No 834 and No 835

Standard: DNV 2.7-1 Type Approved, EN 13889 and U.S Fed. Spec. RR-C-271  
 Material: High Tensile Carbon Steel, Quenched and tempered, Grade 6  
 Finish: All parts hot dip galvanized, pin brown painted on top of galv.  
 Safety factor: 6:1  
 Documentation: Test certificate and traceable raw material / inspection certificate acc. EN 10204 - 3.1.  
 DNV 2.7-1 and DNV 2.7-3 Type Approval Certification.  
 Temperature: -4°F to 392°F

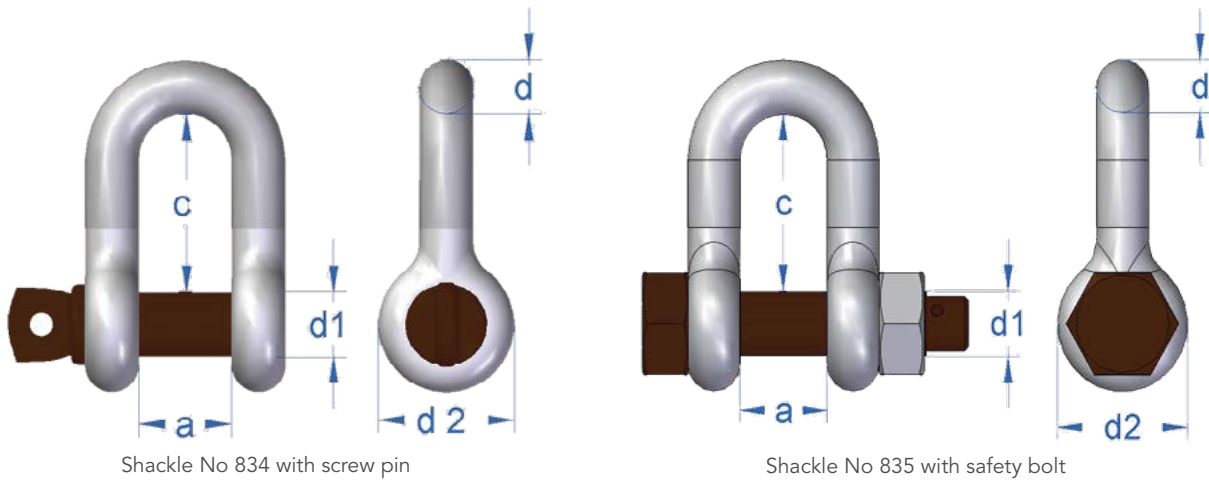

4

CE

Art. no. Screw pin	Art. no. Safety bolt	WLL metric tonnes 6:1	Dim. d1	d Trade size		Inner width a*	Inner length c*	Eye outer d2	Screw pin lb	Safety bolt lb
				mm	inch					
A083405	-	0.33	0.24	5	3/16"	0.39	0.87	0.51	0.04	-
A083406	-	0.5	0.31	7	1/4"	0.47	0.98	0.47	0.13	-
A083408	-	0.75	0.39	9	5/16"	0.53	1.06	0.63	0.24	-
A083409	-	1.0	0.43	10	3/8"	0.67	1.22	0.79	0.33	-
A083411	-	1.5	0.51	11	7/16"	0.73	1.46	0.87	0.46	-
A083413	A083513	2.0	0.63	13	1/2"	0.83	1.61	1.30	0.55	0.66
A083416	A083516	3.25	0.75	16	5/8"	1.06	2.01	1.57	1.21	1.32
A083419	A083519	4.75	0.87	19	3/4"	1.22	2.36	1.89	2.20	2.43
A083422	A083522	6.5	0.98	22	7/8"	1.46	2.80	2.05	2.87	3.31
A083425	A083525	8.5	1.10	25	1"	1.69	3.19	2.36	4.19	4.85
A083428	A083528	9.5	1.26	28	1 1/8"	1.81	3.54	2.52	6.17	6.83
A083432	A083532	12.0	1.38	32	1 1/4"	2.05	3.94	2.83	7.937	9.26
A083435	A083535	13.5	1.50	35	1 3/8"	2.24	4.37	2.99	10.141	12.35
A083438	A083538	17.0	1.65	38	1 1/2"	2.36	4.80	3.31	14	16.53
A083445	A083545	25.0	1.97	45	1 3/4"	2.91	5.87	4.13	25	28.66
A083452	A083552	35.0	2.24	50	2"	3.27	6.73	4.41	35	39.68
-	A083564	55.0	2.76	65	2 1/2"	4.13	7.99	5.71	-	85.980

\* Forging tolerance: +/- 5% on inside width/length.

Split pin included

## Bow Shackle No 854 and No 855

Standard: DNV 2.7-1 Type Approved, EN 13889 and U.S Fed. Spec. RR-C-271  
 Material: High Tensile Carbon Steel, Quenched and tempered, Grade 6  
 Finish: All parts hot dip galvanized, brown painted bolts on top of galv.  
 Safety factor: 6:1  
 Documentation: Test certificate and traceable raw material / inspection certificate acc. EN-10204 - 3.1.  
 DNV 2.7-1 and DNV 2.7-3 Type Approval  
 Temperature: -4°F to 392°F

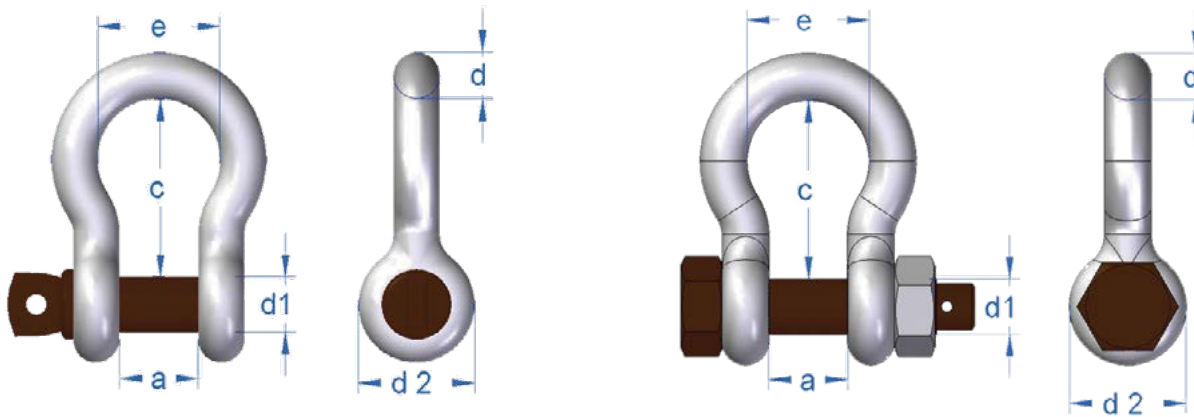

Shackle No 854 with screw pin

Shackle No 855 with safety bolt



Art. no. Screw pin	Art. no. Safety bolt	WLL metric tonnes 6:1	Dim. d1	Trade size		inner width a*	inner length c*	Bow width e	Eye outer d2	Screw pin lb	Safety bolt lb
				mm	inch						
A085405	-	0.33	0.24	5	3/16"	0.39	0.87	0.63	0.51	0.04	-
A085406	A085506	0.5	0.31	6	1/4"	0.47	1.14	0.79	0.63	0.13	0.15
A085408	A085508	0.75	0.39	8	5/16"	0.51	1.26	0.83	0.79	0.24	0.29
A085409	A085509	1.0	0.43	9	3/8"	0.63	1.42	1.02	0.87	0.33	0.37
A085411	A085511	1.5	0.51	11	7/16"	0.71	1.69	1.14	1.02	0.46	0.55
A085413	A085513	2.0	0.63	13	1/2"	0.83	1.85	1.30	1.30	0.82	0.93
A085416	A085516	3.25	0.75	16	5/8"	1.06	2.36	1.65	1.57	1.43	1.54
A085419	A085519	4.75	0.87	19	3/4"	1.22	2.80	1.93	1.89	2.43	2.65
A085422	A085522	6.5	0.98	22	7/8"	1.46	3.31	2.36	2.05	3.31	3.75
A085425	A085525	8.5	1.10	25	1"	1.69	3.74	2.68	2.36	4.87	5.69
A085428	A085528	9.5	1.26	28	1 1/8"	1.81	4.25	2.91	2.52	6.83	7.50
A085432	A085532	12.0	1.38	32	1 1/4"	2.05	4.69	3.27	2.83	9.26	10.58
A085435	A085535	13.5	1.50	35	1 3/8"	2.24	5.20	3.50	2.99	13.23	15.43
A085438	A085538	17.0	1.65	38	1 1/2"	2.36	5.75	3.86	3.31	18	19.84
A085445	A085545	25.0	1.97	45	1 3/4"	2.91	7.01	5.00	4.13	30	33
A085452	A085552	35.0	2.24	50	2"	3.27	7.76	5.43	4.41	42	46
-	A085556	42.5	2.56	57	2 1/4"	3.74	8.74	6.30	5.20	-	63
A085464	A085564	55.0	2.76	65	2 1/2"	4.13	10.24	7.09	5.71	84	86
-	A085576	85.0	3.27	75	3"	5.00	12.99	7.48	6.38	-	137
-	**A085589	120 (5:1)	3.74	95	3 3/4"	5.75	15.75	9.25	8.19	-	243

\* Forging tolerance: +/- 5% on inside width/length.

\*\* Safety factor 5:1

Split pin included

## Arctic Shackle No 856

Bow shackle with safety bolt

### Unique Benefits with The Arctic Shackle

Adverse weather and rough sea conditions in combination with extremely low temperatures, as often encountered in the North Sea for instance, places tough requirements on the products used. Gunnebo Industries has a range of shackles specially designed for these conditions. The Arctic Shackle is type approved to DNV 2.7-1 Offshore containers and meets the impact requirements of 31 ft-lb (42 J) at -40 degrees °F.

The Arctic Shackle is a grade 8 shackle with all parts hot dipped galvanized, including the safety bolt, and has the characteristic brown color marking.



- Standard: DNV 2.7-1, U.S. Fed. Spec. RR.C-271 and EN-13889
- Material: Special Alloy Steel, Quenched and Tempered, Grade 8
- Finish: All parts hot dip galvanized + brown color marking
- Safety factor: As specified in the table below
- Documentation: Test certificate and traceable raw material / inspection certificate acc. to EN-10204 - 3.1 DNV 2.7-1 and DNV 2.7-3 Type Approval Certification.
- Temperature: - 40°F to 392°F

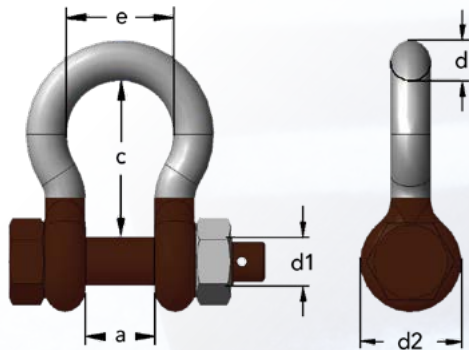

Art. no.	WLL metric tonnes	Dim. d1	d Trade size		a	c	d 2	e	Weight lb	Safety factor
			mm	inch						
A085613	2.0	0.63	13	1/2"	0.83	1.85	1.30	1.30	0.93	8.00
A085616	3.25	0.75	16	5/8"	1.06	2.36	1.57	1.65	1.54	8.00
A085619	4.75	0.87	19	3/4"	1.22	2.80	1.89	1.93	2.65	8.00
A085622	6.5	0.98	22	7/8"	1.46	3.31	2.05	2.36	3.75	7.85
A085625	8.5	1.10	25	1"	1.69	3.74	2.36	2.68	5.51	7.25
A085628	9.5	1.26	28	1 1/8"	1.81	4.25	2.52	2.91	7.50	6.94
A085632	12.0	1.38	32	1 1/4"	2.05	4.69	2.83	3.27	10.58	6.40
A085635	13.5	1.50	35	1 3/8"	2.24	5.20	2.99	3.50	15.43	6.10
A085638	17.0	1.65	38	1 1/2"	2.36	5.75	3.31	3.86	19.84	6.00
A085645	25.0	1.97	45	1 3/4"	2.91	7.01	4.13	5.00	33.07	6.00
A085652	35.0	2.24	50	2"	3.27	7.76	4.57	5.43	46.30	6.00
A085664	55.0	2.76	65	2 1/2"	4.13	10.24	5.71	7.09	85.98	6.00
A085676	85.0	3.27	75	3"	5.00	12.99	6.38	7.48	136.69	6.00

Split pin included

# Super Shackle No 858

Bow shackle with safety bolt

## Unique Benefits with The Super Shackle

In certain situations, a demand for extra Working Load Limit occurs, in others the lifting environment has limited space for the lifting application. Gunnebo Industries has therefore added the Super Shackle to the range, enabling the same Working Load Limit on a 7/8" in Super shackle as for a 1-1/8" in Standard shackle.

The Super shackle meets the US Federal Specification RR.C-271. It is a grade 8 shackle and has all parts hot dipped galvanized, including the safety bolt.



- Standard: U.S. Fed. Spec. RR.C-271 Type IVA Class 3, Grade B
- Material: High Tensile Steel. Quenched and Tempered, Grade 8
- Finish: All parts hot dip galvanized + brown color marking
- Safety factor: 5:1
- Documentation: Test certificate and traceable 3.1 certificate
- Temperature: -4 °F to 392 °F

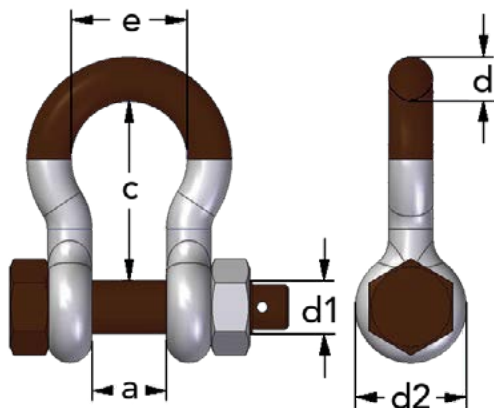

Art.no	WLL metric tonnes	Dim. d1	d Trade size		a	c	d2	e	Weight lb
			mm	inch					
A085813	3.3	0.63	13	1/2"	0.83	2.01	1.30	1.30	0.88
A085816	5.0	0.75	16	5/8"	1.06	2.36	1.57	1.65	1.54
A085819	7.0	0.87	19	3/4"	1.22	2.80	1.89	1.93	2.65
A085822	9.5	0.98	22	7/8"	1.46	3.31	2.05	2.36	3.75
A085825	12.5	1.10	25	1"	1.69	3.74	2.36	2.68	5.51
A085828	15.0	1.26	28	1 1/8"	1.81	4.25	2.52	2.91	7.50
A085832	18.0	1.38	32	1 1/4"	2.05	4.69	2.83	3.27	10.58
A085835	21.0	1.50	35	1 3/8"	2.24	5.20	2.99	3.50	15.43
A085838	30.0	1.65	38	1 1/2"	2.36	5.75	3.31	3.86	19.40
A085845	40.0	1.97	45	1 3/4"	2.91	7.01	4.13	5.00	33.07
A085857	55.0	2.24	57	2"	3.27	7.76	4.61	5.43	48.50
A085870	85.0	2.76	70	2 1/2"	4.13	10.24	5.63	7.09	83.78
A085883	120.0	3.27	83	3"	5.00	12.95	6.38	7.48	154.32
A085895	150.0	3.74	95	3 1/2"	5.79	15.75	8.19	9.37	246.92

Split pin included

# Aquaculture

## Because safety is everything

Gunnebo Industries has an in-depth knowledge of the demands aquaculture puts on the products supplied. With over 100 years of experience gained manufacturing shackles and chain for maritime use, which allows us to provide our clients with the highest level of satisfaction, even in the most extreme environments.

Whilst other producers have been focusing on low cost to the detriment of performance, we have focused on quality and improved properties to give best value for money. Products such as our hot dip galvanized chain and shackles are designed to satisfy the specific demands from the global fishing industry.

Gunnebo Industries products are the best choice when safety and quality comes first. We have always and will continue to provide the Aquaculture industry with the preferred products available in the market. All of our aquaculture products are independently approved according to Norwegian standard NS 9415. NS 9415 with this being the first national standard for aquaculture mooring systems.

Our continuous focus on quality has been proven by our achievements with the key industry standards:

- Approved acc. to ISO 9001
- Approved acc. to ISO 14001
- Product certification acc. to NS 9415



## Mooring Shackle No 852

### Unique Benefits with Mooring Shackle

The Mooring Shackle has a sunken bolt that locks into the shackle to prevent rotation (unintentional loosening of the nut). The sunken bolt also reduces the risk of the shackle interacting with the net. Fatigue resistance is increased by the addition of 25% extra material in the bow (increased life span and safety).

The shackle has a spacious bow for connecting thimbles, rope and mooring/connecting plates.

Standard: Third party approved to relevant Norwegian aquaculture standards

Material: High Tensile Steel. Quenched and Tempered, Grade 6

Finish: All parts hot dip galvanized + brown color marking

Plastic clip provided as standard safety pin for 3/4T - 1 1/4T,  
Stainless steel A4 split pins provided as standard for 15/8T and 13/4T

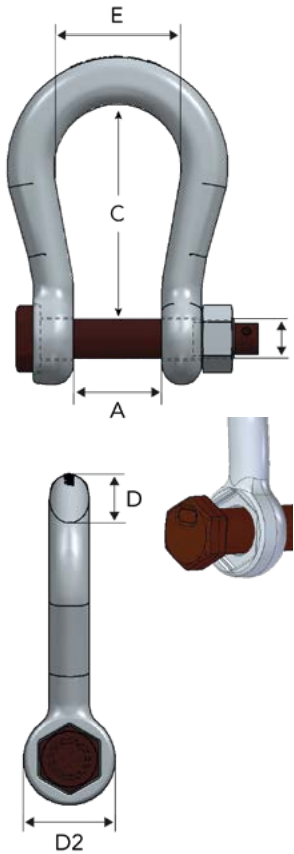

Art.no	MBL lb	D Trade size		A	C	E	D2	D1
		mm	inch					
*A085219	61 712	19	3/4"	1.73	3.94	2.28	1.89	0.87
*A085222	88 160	22	7/8"	2.05	4.92	2.68	2.05	0.98
*A085228	132 240	28	1 1/8"	2.44	5.91	3.50	2.52	1.10
*A085232	198 360	32	1 1/4"	3.23	6.69	3.86	2.83	1.26
A085242	242 440	42	1 5/8"	4.41	7.87	5.91	3.54	1.77
A085245	330 600	45	1 3/4"	4.96	9.76	6.89	4.13	1.97

\* These sizes come with a sunken hexagon bolt head that will greatly reduce the risk of the bolt unscrewing in service as well as making the fitting easier for the user.

### Customized securing options

- Clips (3/4T to 7/8T) - Yellow
- Clips (1 1/8T to 1 1/4T) - Green
- Plastic covered seizing wire
- Plastic covered steel wire
- Stainless steel cotter pin

## Countersunk Shackle No 830

Standard: Third party approved to relevant Norwegian aquaculture standards

Material: High Tensile Steel. Quenched and Tempered, Grade 6

Finish: All parts hot dip galvanized + brown color marking

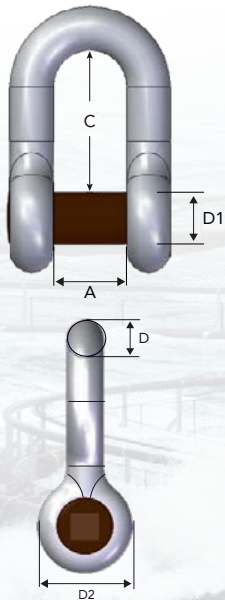

Art.no	Art.no*	WLL metric tonnes	Dim. D		A	C	D1	D2	Square hole	Recommended Key
			mm	inch						
A083013	A083013DP	2.0	13	1/2"	0.83	1.61	0.63	1.30	0.39 x 0.39	3/8"
A083016	A083016DP	3.2	16	5/8"	1.06	2.01	0.75	1.57	0.39 x 0.39	3/8"
A083019	A083019DP	5.0	19	3/4"	1.22	2.36	0.87	1.89	0.39 x 0.39	3/8"
A083022	A083022DP	6.5	22	7/8"	1.46	2.80	0.98	2.05	0.55 x 0.55	1/2"
A083025	A083025DP	8.5	25	1"	1.69	3.19	1.10	2.36	0.55 x 0.55	1/2"

\* Countersunk Shackles can also be supplied with a secondary securing for Double Protection (DP), for mooring applications.

## Long link Chain LLZ - see chapter 5





## Mooring bolt - Eye Bolt No 8250

Standard: Third party approved to relevant Norwegian aquaculture standards

Material: High Tensile Steel. Quenched and Tempered, Grade 6

Finish: All parts hot dip galvanized + brown color marking

Art.no	MBL lb	Dim Ø x L	G	E
A825032	88 160	Ø1.26 x 15.75	2.83	1.46
A825038	132 240	Ø1.50 x 19.69	3.31	1.73
A825045	176 320	Ø1.77 x 23.62	4.13	1.85

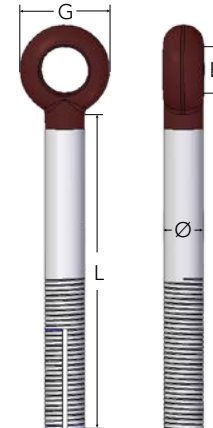

## Mooring bolt - T-bolt No 825

Standard: Third party approved to relevant Norwegian aquaculture standards

Material: High Tensile Steel. Quenched and Tempered, Grade 6

Finish: All parts hot dip galvanized + brown color marking

Art.no	MBL lb	Dim Ø x L	G	E
A825232	88 160	Ø1.26 x 15.75	2.83	1.38
A825238	132 240	Ø1.50 x 19.69	3.31	1.65
A825445	176 320	Ø1.77 x 19.69	4.13	1.77
A825245	176 320	Ø1.77 x 23.62	4.13	1.77
A825450	220 400	Ø1.97 x 19.69	3.94	1.77
A825250	220 400	Ø1.97 x 27.56	4.33	1.97

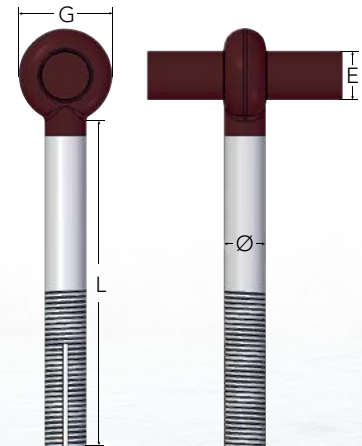

4

## Galvanized Master Link

Standard: Third party approved to relevant Norwegian aquaculture standards

Material: High Tensile Steel. Quenched and Tempered, Grade 6

Finish: All parts hot dip galvanized

Art.no	MBL lb	Dim Ø (D)	B	L
A825922	88 160	Ø7/8"	3.74	6.30
A825928	132 240	Ø1 3/8"	4.33	7.48
A825934	176 320	Ø1 3/8"	5.51	9.45
A825940	242 440	Ø1 5/8"	5.91	9.84

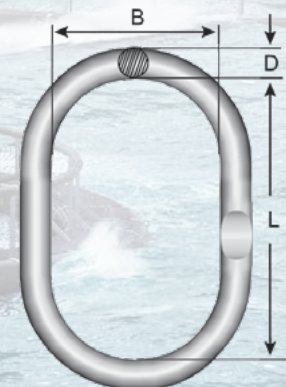

# ROV Shackles

The ROV Retrieve Shackle is designed for smooth and easy use in retrieving and releasing subsea lifting and rigging operations. It has no loose parts, in closed or opened position, and there is therefore no need for wires or monkey fists that will risk snagging or getting in the way.

The high visibility handles are close-die forged and has double safety functions - shark tooth locking with indicator that will show if the shackle is in open or locked position as well as the spring loaded handle. The handle is the same size, regardless of size of shackle.

The ROV Retrieve Shackle no. 861 is an easy to operate shackle, saving valuable time and money.

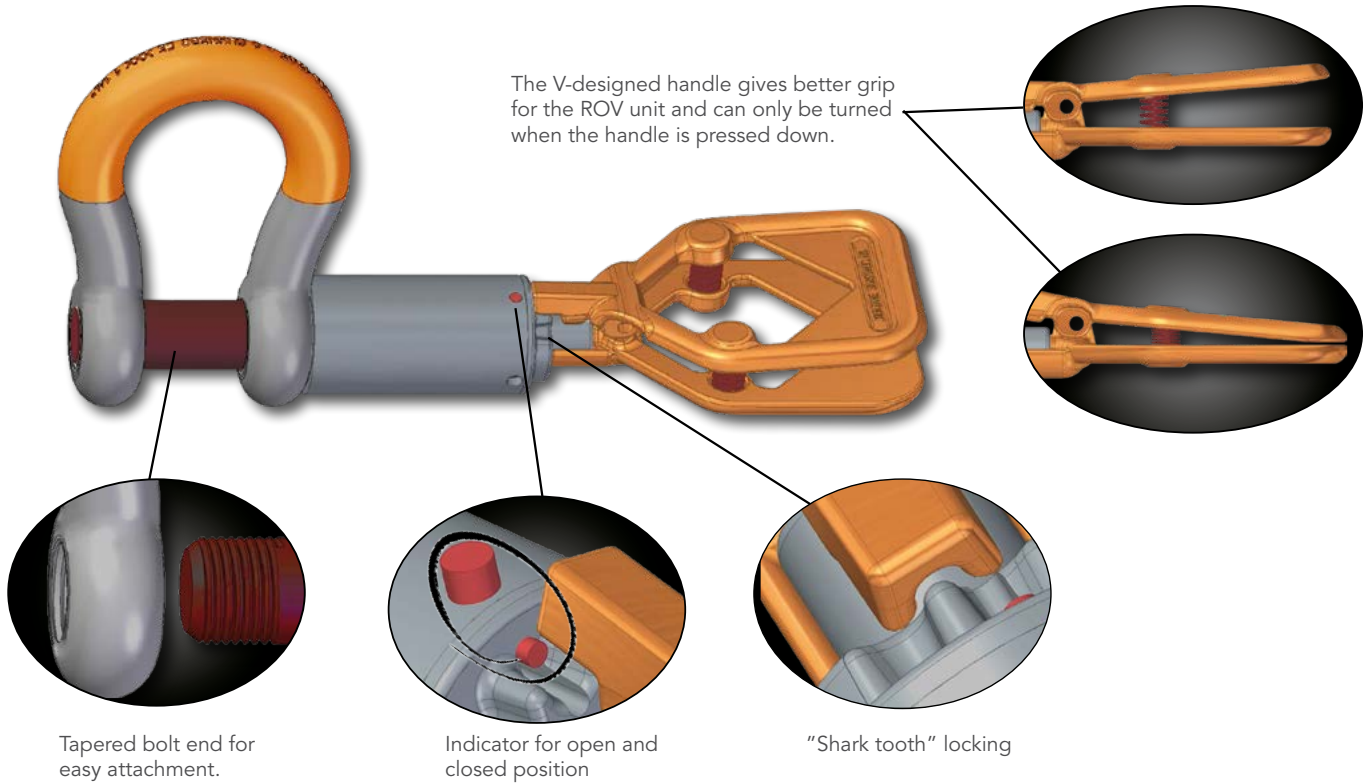

## ROV Retrieve Shackle No 861

All shackles have unique marking

Standard: Dim. according to EN 13889  
 Material: High Tensile Steel, Quenched and Tempered  
 Finish: All load bearing parts hot dip galvanized  
 Safety factor: 6:1  
 Documentation: Test certificate and traceable 3.1 certificate supplied on request.  
 Temperature: -40 °F to 392 °F

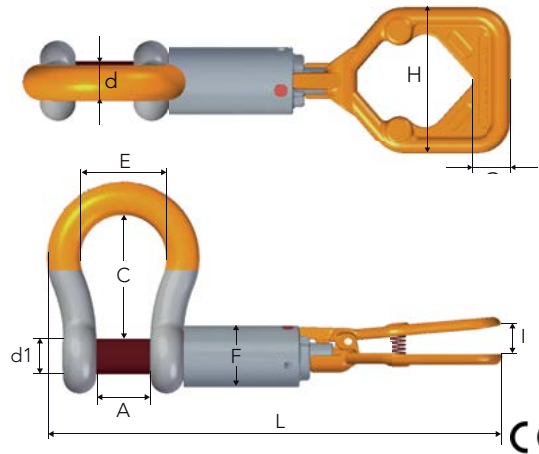

Art. no	WLL metric tonnes	d1	d	A	C	E	F	L	I	H	G	Weight lb
A086128	9.5	1.26	1.10	1.81	4.25	2.91	2.36	17.32	1.22	5.20	1.30	14.33
A086132	12.0	1.38	1.26	2.05	4.69	3.27	2.36	18.11	1.22	5.20	1.30	17.64
A086138	17.0	1.65	1.50	2.36	5.75	3.86	2.50	19.72	1.22	5.20	1.30	23.15
A086145	25.0	1.97	1.77	2.91	7.01	5.00	2.76	22.24	1.22	5.20	1.30	36.38
A086152	35.0	2.24	1.97	3.27	7.76	5.43	2.99	23.78	1.22	5.20	1.30	45.19
A086164	55.0	2.76	2.56	4.13	10.24	7.09	3.46	28.03	1.22	5.20	1.30	92.59

## ROV Shackle No 860

Threaded bolt with one locking pin

Standard:	Dim. according to EN 13889
Material:	High Tensile Steel, Quenched and Tempered
Finish:	All load bearing parts hot dip galvanized
Safety factor:	6:1
Documentation:	Test certificate and traceable 3.1 certificate supplied on request.
Temperature:	-40 °F to 392 °F



Art. no.	WLL metric tonnes	d1	d	a	c	d2	e	Weight lb
A086028	9.5	1.26	1.10	1.81	4.25	2.52	2.68	7.50
A086032	12.0	1.38	1.26	2.05	4.69	2.83	3.27	11.02
A086038	17.0	1.65	1.50	2.36	5.75	3.31	3.86	17.20
A086045	25.0	1.97	1.77	2.91	7.01	4.13	5.00	30.64
A086052	35.0	2.24	1.97	3.27	7.76	5.00	5.43	37.48
A086064	55.0	2.76	2.56	4.13	10.24	5.98	7.09	81.57

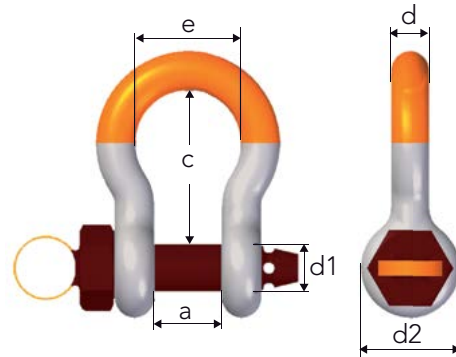

4

## ROV Release Shackle No 863

Equipped with bolt and two locking pins

Standard:	Dim. according to EN 13889
Material:	High Tensile Steel, Quenched and Tempered
Finish:	All load bearing parts hot dip galvanized
Safety factor:	5:1
Documentation:	Test certificate and traceable 3.1 certificate supplied on request.
Temperature:	-40 °F to 392 °F



Art. no.	WLL metric tonnes	d1	d	a	c	d2	e	Weight lb
A086322	6.5	0.98	0.87	1.46	3.31	2.05	2.28	3.53
A086328	9.5	1.26	1.10	1.81	4.25	2.52	2.91	7.50
A086332	12.0	1.38	1.26	2.05	4.69	2.83	3.27	11.02
A086338	17.0	1.65	1.50	2.36	5.75	3.31	3.86	17.20
A086345	25.0	1.97	1.77	2.91	7.01	4.13	5.00	30.64
A086352	35.0	2.24	1.97	3.27	7.76	5.00	5.43	37.48
A086364	55.0	2.76	2.56	4.13	10.24	5.98	7.09	81.57

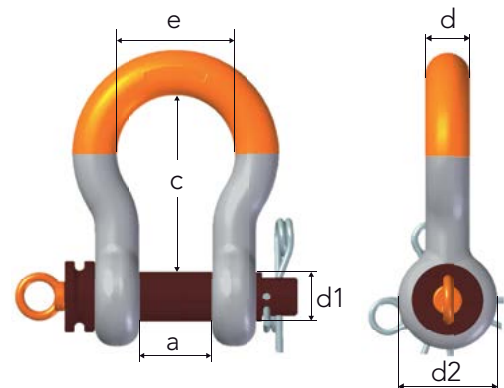

## Stainless Steel Shackle No 735

Dee shackle with safety bolt

Material: AISI 316  
 Finish: Highly Polished  
 Safety factor: 6:1  
 Documentation: Test certificate and traceable 3.1 certificate supplied on request.

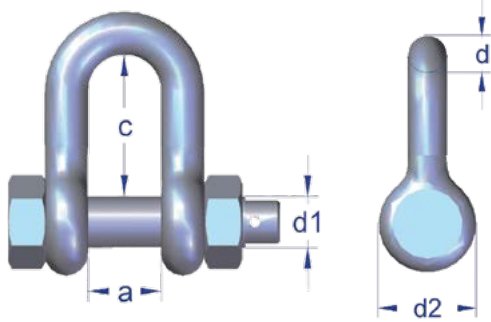

Art, no,	WLL metric tonnes	d1	d	a	c	d2	Weight lb
A073510	0.6	0.39	0.39	0.79	1.50	0.79	0.44
A073512	0.9	0.47	0.47	1.02	1.97	0.94	0.66
A073516	1.5	0.63	0.51	0.94	2.05	1.30	0.88
A073520	2.5	0.75	0.63	1.10	2.56	1.57	1.54
A073522	3.0	0.87	0.75	1.22	2.36	1.89	3.31
A073524	4.5	0.98	0.87	1.46	2.80	2.05	2.87
A073533	7.5	1.26	1.10	1.81	3.54	2.52	6.61
A073536	10.0	1.38	1.26	2.05	3.94	2.83	9.04

Split pin included

## Stainless Steel Shackle No 755

Bow shackle with safety bolt

Material: AISI 316  
 Finish: Highly Polished  
 Safety factor: 6:1  
 Documentation: Test certificate and traceable 3.1 certificate supplied on request.

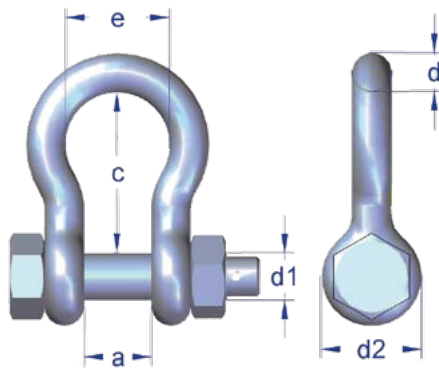

Art. no.	WLL metric tonnes	d1	d	a	c	e	d2	Weight lb
A075510	0.6	0.39	0.39	0.79	1.42	1.06	0.79	0.44
A075512	0.9	0.47	0.47	0.98	1.85	1.46	1.02	0.66
A075516	1.5	0.63	0.51	0.98	1.85	1.30	1.34	0.88
A075520	2.5	0.79	0.63	1.10	2.36	1.65	1.57	1.76
A075522	3.0	0.87	0.75	1.22	2.80	2.01	1.89	2.87
A075524	4.5	0.98	0.87	1.46	3.31	2.28	2.05	3.75
A075533	7.5	1.26	1.10	1.81	4.25	2.91	2.52	7.50
A075536	10.0	1.38	1.26	2.05	4.69	3.27	2.83	11.46

Split pin included

## Stainless Steel Shackle No 732

Dee shackle with countersunk pin

Material: AISI 316  
 Finish: Highly Polished  
 Safety factor: 6:1  
 Documentation: Test certificate supplied on request.

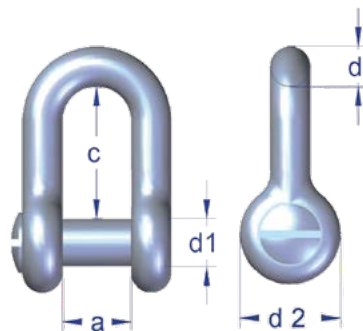

Art. No.	WLL metric tonnes	Dim. d1	d1	d	a	(c)	d2	Weight lb
A073216	2.0	0.63	0.63	0.51	0.94	2.05	1.34	0.66
A073220	3.0	0.79	0.79	0.63	1.10	2.56	1.57	1.32
A073222	3.0	0.87	0.87	0.75	1.22	2.36	1.89	3.09

## Stainless Steel Shackle No 730

Dee shackle with screw pin

Material: AISI 316  
 Finish: Highly Polished  
 Safety factor: 6:1  
 Documentation: Test certificate supplied on request.

Art. no.	WLL metric tonnes	Dim. d1	d	a	c	d2	Weight lb
A073008S	0.4	0.31	0.31	0.63	1.18	0.63	0.13
A073010S	0.6	0.39	0.39	0.79	1.50	0.79	0.22
A073012S	0.9	0.47	0.47	1.02	1.97	0.94	0.44
A073016S	1.5	0.63	0.51	0.94	2.05	1.34	0.66
A073020S	2.5	0.79	0.63	1.10	2.56	1.57	1.32
A073022S	3.0	0.87	0.75	1.18	2.83	1.89	1.98

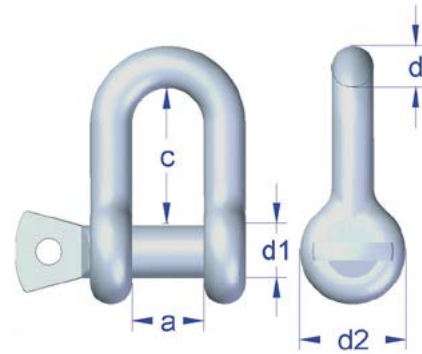

## Stainless Steel Shackle No 750

Bow shackle with screw pin

Material: AISI 316  
 Finish: Highly Polished  
 Safety factor: 6:1  
 Documentation: Test certificate supplied on request.

Art. no.	WLL metric tonnes	Dim. d1	d1	d	a	c	e	d2	Weight lb
A075008S	0.4	0.31	0.31	0.31	0.63	1.18	0.91	0.63	0.15
A075010S	0.6	0.39	0.39	0.39	0.79	1.42	1.06	0.79	0.24
A075012S	0.9	0.47	0.47	0.47	0.98	1.85	1.46	1.02	0.55
A075016S	1.5	0.63	0.51	0.51	0.98	1.85	1.34	1.30	0.73
A075020S	2.5	0.79	0.63	0.63	1.10	2.36	1.65	1.57	2.12
A075022S	3.0	0.87	0.75	0.75	1.22	2.80	2.01	1.89	2.20

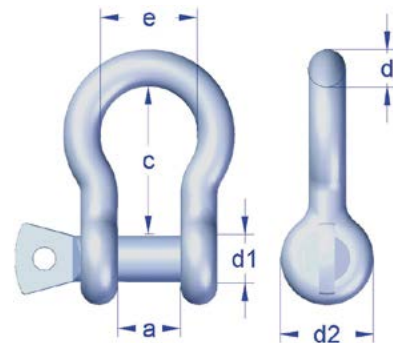

## Shackle SA

Grade 8

EN 1677-1

Finish: Painted yellow  
 Material: Alloy steel  
 Safety factor: 4:1

Art. no.	Code	WLL metric tonnes	For chain dim.	c	a	d	d2	d1	Weight lb
Z100706	SA-7/8-8	2.0	9/32", 5/16"	1.18	0.59	0.31	0.79	0.39	0.22
Z298728	SA-10-8	3.2	3/8"	2.05	0.94	0.51	1.34	0.63	0.88
Z292528	SA-13-8	5.4	1/2"	2.56	1.10	0.63	1.57	0.79	1.54
Z293024	SA-16-8	8.2	5/8"	2.83	1.18	0.71	1.81	0.87	2.20
Z299622	SA-19-8	11.5	3/4"	3.39	1.42	0.87	2.05	1.06	3.75
Z294122	SA-22-8	15.5	7/8"	3.70	1.57	0.98	2.36	1.18	5.51
Z304328	SA-26-8	21.7	1"	4.57	1.89	1.26	2.99	1.54	11.46

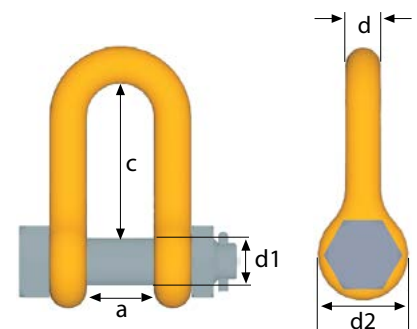

Split pin included

# Alloy Steel Rigging Screw, No 801, 802, 804

Grade 6

Standard: Working load acc. to U.S. Fed. spec. FF-T-791.b  
 Supplied with closed body from 5 510 - 37 468 lb, larger dimensions open body.  
 Material: Quenched and tempered alloy steel  
 Surface treatment: Hot dip galvanized  
 Safety factor: 5:1  
 Certificate: Test certificate and traceable 3.1 certificate supplied on request.  
 Tolerances: +/- 5%  
 Temperature: -4 °F to 392 °F

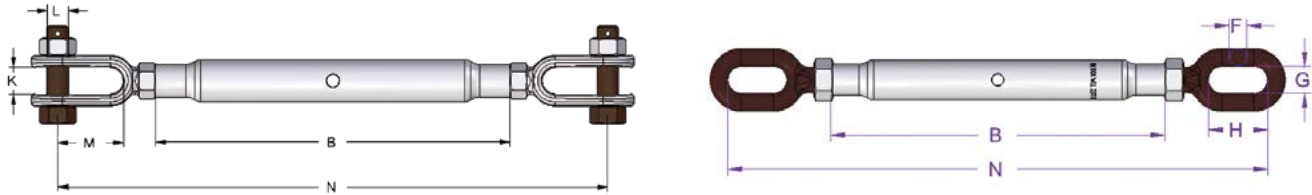

Art. no. Jaw/Jaw	Art. no. Jaw/Eye	Art. no. Eye/Eye	Thread M/UNC	WLL metric tonnes	Take up range	B	N	K	L	M	F	G	H	Weight lb/ea
A801420	A802420	A804420	M 20	2.5	8.27	10.63	17.91	0.79	0.63	1.97	0.51	0.83	1.77	5.07
A801424	A802424	A804424	M 24	5.0	9.84	13.39	22.44	1.10	0.87	2.56	0.75	1.10	2.20	10.14
A801432	A802432	A804432	1.1/4"	7.0	10.63	14.57	26.77	1.50	1.10	3.35	0.87	1.38	2.76	17.64
A801438	A802438	A804438	1.1/2"	10.0	11.81	15.75	31.10	1.77	1.26	3.94	0.98	1.57	3.07	30.86
A801445	A802445	A804445	1.3/4"	13.0	14.17	19.69	34.25	1.97	1.54	4.13	1.18	1.77	3.54	52.91
A801450	A802450	A804450	2"	17.0	17.72	23.62	40.55	2.28	1.77	4.72	1.38	1.77	3.94	83.78
A801464			*2.1/2"	27.2	21.02	30.71	51.65	2.95	2.24	5.59				194.01
A801470			*2.3/4"	34.0	22.68	30.71	55.83	3.54	2.76	5.71				216.05

\* Open turnbuckle body without nut and split pin

# Rigging Screw No 401, 402, 404 - Hot Dip Galvanized

Design: Jaw-Jaw (jaw-eye and eye-eye on request)  
 Standard: Acc.to B.S. 4429, closed body - with locking nut  
 Material: St. 42/St. 52, normalized  
 Surface treatment: Hot dip galvanized (M6 & M8 zinc plated)  
 Safety factor: 5:1  
 Note: The items marked with \* below are not for lifting  
 Tolerances: +/-5%

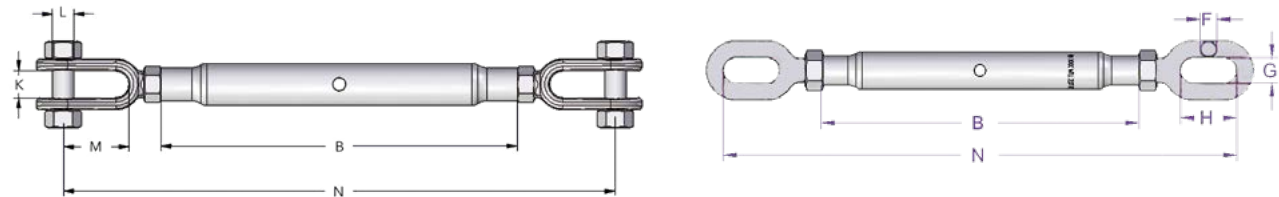

Art. no. Jaw/ Jaw	Art. no. Jaw/ Eye	Art.no Eye/Eye	Thread M/ UNC	WLL metric tonnes	Take up range	B	N	L	M	K	F	G	H	Weight lb/pcs
	*A402406		M 6	-	3.15	3.94	6.89	0.20	0.71	0.31	0.20	0.39	0.39	0.29
	*A402408		M 8	-	3.35	4.33	8.27	0.24	0.83	0.35	0.24	0.47	0.47	0.55
A401510	*A402410	*A404410	M 10	0.5	3.54	5.71	8.86	0.31	0.79	0.37	0.28	0.51	0.51	0.66
A401512	*A402412	*A404412	M 12	0.7	6.10	7.68	12.40	0.39	1.18	0.51	0.39	0.55	1.10	1.43
A401516	*A402416	*A404416	M 16	1.2	7.28	9.06	14.96	0.47	1.73	0.71	0.47	0.71	1.77	2.76
A401520	A402420	A404520	M 20	1.5	8.27	10.63	17.72	0.63	1.97	0.79	0.51	0.83	1.77	4.85
A401422	A402422	A404422	M 22	2.2	9.06	11.61	19.69	0.79	2.36	0.98	0.63	0.94	1.97	7.28
A401424	A402424	A404424	M 24	3.2	9.84	12.80	21.85	0.87	2.56	1.10	0.75	1.10	2.20	10.14
A401432	A402432	A404432	1.1/4"	4.8	11.42	14.57	26.77	1.10	3.35	1.50	0.87	1.38	2.76	18.74
A401438	A402438	A404438	1.1/2"	6.0	11.81	15.75	29.92	1.26	3.94	1.77	0.98	1.57	3.54	31.97
A401445	A402450	A404445	1.3/4"	8.5	11.42	15.75	29.92	1.50	4.13	1.97	1.18	1.77	3.54	46.08
A401452	A402452	A404452	2"	11.0	11.42	15.75	32.28	1.77	4.72	2.28	1.38	1.77	3.94	52.91

\* Will not be delivered with lifting certificate.

# Technical Information

2006/42/EC highlights the responsibility of the manufacturer, distributor and end user of lifting gear. Gunnebo Industries shackles are specified, monitored and documented in compliance with the most stringent requirements for the product concerned. A certified ISO 9001:2008 to 9001:2015 system is an evidence of our quality standard. See website or user instructions for assembly instructions. Meets listed current specifications and standards at time of publication of this catalogue.

## Instructions For Safe Use

1. The user is obliged to keep a valid Test Certificate for any shackle being used in a lifting operation.
2. Before use each shackle should be inspected to ensure that:
  - all markings in the body and the pin of the shackle are legible and in compliance with the relevant Test Certificate.
  - the shackle pin is of the correct type.
  - the body and pin are not distorted or unduly worn.
  - The body and pin are free from nicks, cracks, grooves and corrosion.
  - If there is any doubt with regards to the above criteria being met, the shackle should not be used for a lifting operation.
3. It is important to ensure that the pin is safely locked after assembly. For repeated lifting between inspections of the gear, it is recommended to use a safety bolt type shackle with nut and split-pin - the user must ensure that the split-pin is fitted, to prevent the nut from unscrewing during use.
4. Incorrect seating of a pin may be due to a bent pin, damaged threads or misalignment of the holes. Do not use the shackle under these circumstances, but refer the matter to a competent person (i.e. dealer, manufacturer)
5. Shackles should be fitted to the load in a manner that allows the shackle body to take the load in a true line along its centerline to avoid undue bending stresses which will reduce the load capacity of the shackle. When using shackles in conjunction with multi-leg slings, due consideration should be given to the effect of the angle between the sling legs. When a shackle is used to secure the top block of a set of rope blocks the load on this shackle is increased by the value of the hoisting effect.
6. To avoid eccentric loading of the shackle it is recommended to distribute the load as far as possible over the total length of the pin or to use loose spacers.
7. Never modify, repair or reshape a shackle by welding, heating or bending as this will affect the nominal WLL.
8. Never heat treat a shackle as this may affect the WLL.

Side loads should be avoided as the products are not designed for this purpose. If side loads cannot be avoided, the following reduction factors must be taken into account:

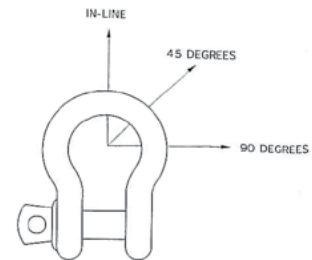

### Reduction for side loading

Load angle	New Working Load Limit
0°	100% of original WLL
45°	70% of original WLL
90°	50% of original WLL

Avoid applications where, due to load movement, the shackle pin can rotate

Shackle must be loaded in straight direction

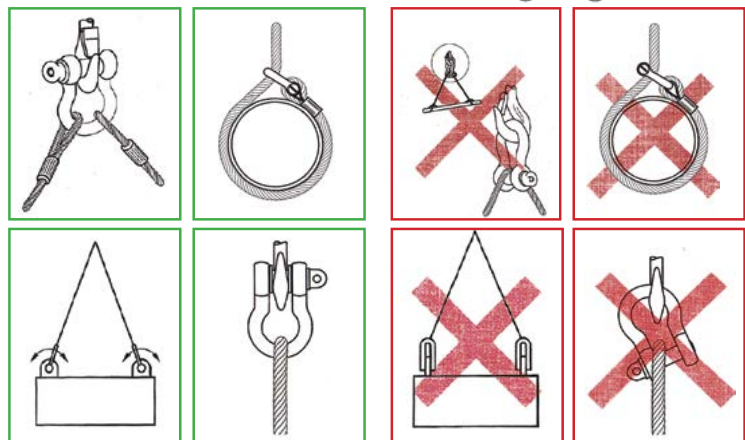

## Temperature

If extreme temperature situations are applicable, the following load reductions must be taken into account.

### Reduction for elevated temperatures

Temperature:	New Working Load Limit
-4 - 392 °F	100% of original Working Load Limit
392 - 572 °F	90% of original Working Load Limit
572 - 752 °F	75% of original Working Load Limit
> 752 °F	not allowed

# Chain

Grade 10 • Grade 8 • Short Link • Mid-link • Long-link

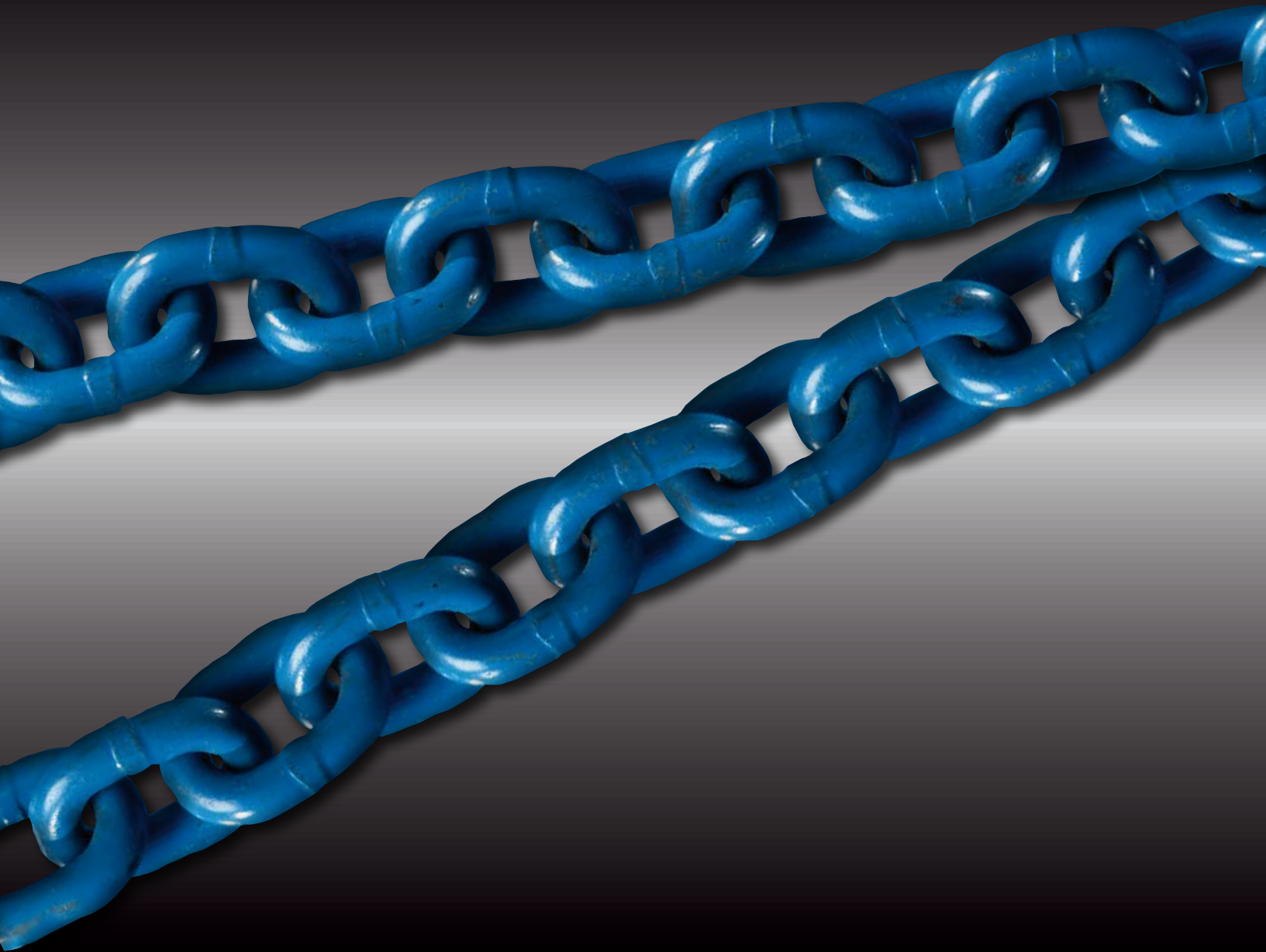

**GUNNEBO**  
Industries



## Chain

Chain, Grade 10 (200), GrabiQ	5:3
Chain, Grade 10 (400), GrabiQ	5:3
Chain, Short Link, Grade 8, Classic	5:3
Chain, Short Link, Grade 8	5:4
Chain, Mid-link, Grade 8	5:4
Chain, Long-link, Grade 8	5:4
Chain, Short Link, Galvanized, Grade 7	5:5
Chain, Mid-link, Galvanized, Grade 7	5:5
Chain, Long-link, Galvanized, Grade 6/7	5:5

## Technical Information

Chain Manufacturing	5:6
Safe Use and Extreme environments	5:7
Definitions	5:7

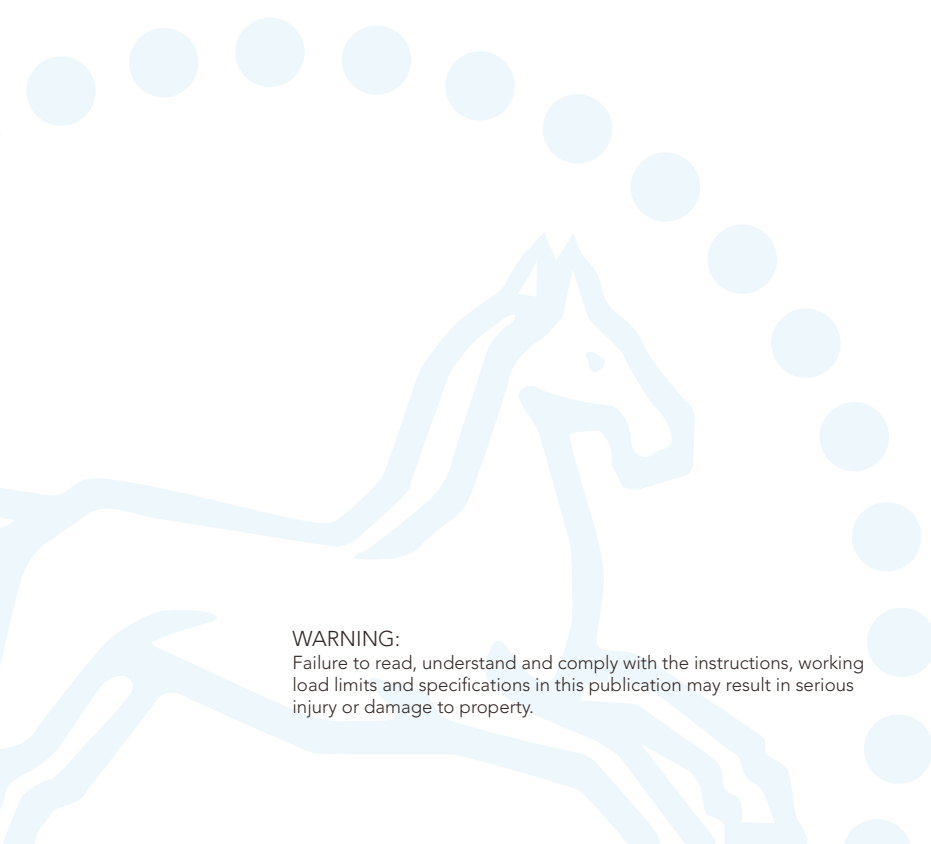

**WARNING:**  
Failure to read, understand and comply with the instructions, working load limits and specifications in this publication may result in serious injury or damage to property.



## Chain, GrabiQ Grade 10 (200)

Short link, KL

Heat treatment  
Quenched and tempered.  
Note! For chain grade 10 (200) the maximum in service temperature is 392°F.

Surface treatment  
Painted blue

Fulfills the requirements in:  
ASTM A973/A973M-07(2012)  
EN 818+2:2008 (WLL +25%,  
reduced temperature range)

Art. no. Box	Code	WLL lb	d nom.	P	w1	Weight lb/foot	MPF kN	Breaking force lb
Z802300 - 1 x 656 ft	KLA 6-10 (200)	3 306	(6mm)	0.71	0.33	0.54	8 272	13 240
Z802337 - 1 x 656 ft	KLA 7-10 (200)	4 300	9/32"	0.83	0.39	0.74	10 790	17 309
Z802301 - 1 x 656 ft	KLA 8-10 (200)	5 700	5/16"	0.94	0.43	0.94	14 162	22 929
Z802302 - 1 x 328 ft	KLA 10-10 (200)	8 800	3/8"	1.18	0.55	1.55	22 030	35 518
Z802303 - 1 x 328 ft	KLA 13-10 (200)	15 000	1/2"	1.54	0.70	2.55	37 316	60 246
Z802304 - 1 x 328 ft	KLA 16-10 (200)	22 600	5/8"	1.89	0.86	3.77	56 424	90 369
Z802305 - 1 x 164 ft	KLA 20-10 (200)	35 300	3/4"	2.36	1.06	6.32	88 346	141 624
Z802246 - 1 x 164 ft	KLA 22-10 (200)	44 080	7/8"	2.60	1.14	7.93	110 376	176 468
Z802248 - 1 x 164 ft	KLA 26-10 (200)	59 500	1"	3.07	1.38	9.81	149 267	238 737
Z802440 - 1 x 82 ft	KLA 32-10 (200)	88 160	1-1/4"	3.78	1.64	16.40	220 528	361 928

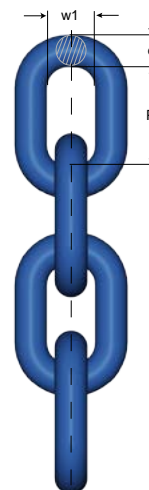

## Chain, GrabiQ Grade 10 (400)

Short link, KL

Heat treatment  
Quenched and tempered.  
Note! For chain grade 10 (400) the maximum in service temperature is 752°F.

Surface treatment  
Painted blue

Fulfills the requirements in:  
EN 818-2:2008 (WLL+25%,  
material dimension  $\varnothing$  +10%)

Note: This chain is marked with "8+" in addition to the marking required by the machine directive

Art. no. Box	Code	WLL lb	d nom.	P	w1	Weight lb/foot	MPF kN	Breaking force lb
Z802306 - 1 x 656 ft	KLA 6-10 (400)	3 306	0.26	0.71	0.35	0.67	8 272	13 218
Z802307 - 1 x 656 ft	KLA 8-10 (400)	5 700	0.35	0.94	0.44	1.14	14 162	22 929
Z802308 - 1 x 328 ft	KLA 10-10 (400)	8 800	0.43	1.18	0.57	1.75	22 030	35 518
Z802309 - 1 x 328 ft	KLA 13-10 (400)	15 000	0.56	1.54	0.76	3.02	37 316	60 246
Z802310 - 1 x 328 ft	KLA 16-10 (400)	22 600	0.68	1.89	0.91	4.50	56 424	90 369

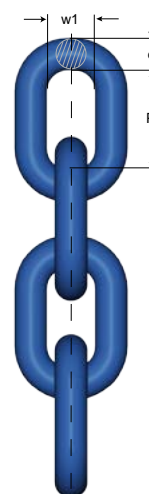

5

## Chain, Classic Grade 8

Short link, KL

Heat treatment  
Quenched and tempered.

Surface treatment  
Painted black (KLB)  
Painted yellow (KLU)

Fulfills the requirements in:  
EN 818-2:2008, AS 2321:2014,  
ASTM A391/A 391M-07 (2012)

Art. no. Box	Code	WLL lb*	d nom.	P	w1	Weight lb/foot	Manufacturing proof force lb	Breaking force lb
Z802174 - 1 x 656 ft	KLB 6-8E	2 500	(6mm)	0.71	0.33	0.54	6 362	10 161
Z802175 - 1 x 656 ft	KLB 7-8E	3 500	9/32"	0.83	0.39	0.74	8 655	13 938
Z802176 - 1 x 656 ft	KLB 8-8E	4 500	5/16"	0.94	0.43	0.94	11 308	18 120
Z802156 - 1 x 328 ft	KLB 10-8E	7 100	3/8"	1.18	0.55	1.55	17 760	29 225
Z802157 - 1 x 328 ft	KLB 13-8E	12 000	1/2"	1.54	0.70	2.55	29 900	48 109
Z802177 - 1 x 328 ft	KLB 16-8E	18 000	5/8"	1.89	0.86	3.77	45 187	72 389
Z801203 - 1 x 328 ft	KLB 19-8E	25 600	3/4"	2.24	1.06	5.24	63 846	102 738
Z801228 - 1 x 164 ft	KLB 22-8E	34 200	7/8"	2.60	1.16	7.13	85 428	137 134
Z801231 - 1 x 164 ft	KLB 26-8E	47 700	1"	3.07	1.38	9.95	119 374	191 089
Z801232 - 1 x 82 ft	KLB 32-8E	72 300	1-1/4"	3.78	1.64	14.52	180 747	292 253

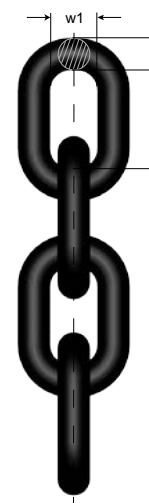

## Short Link Chain KLFU, Grade 8

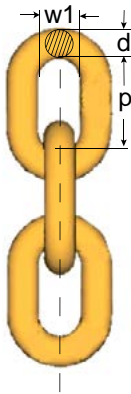

Heat treatment  
 Quenched and tempered,  
 Stress relieved

Surface treatment  
 Painted yellow

Not for lifting purposes

Art. no.	Code	Link dimensions			Weight lb/foot	Min. breaking load (lb)	Delivery length
		d nom.	P	w1			
Z802330	KLFU-10-8	3/8"	1.18	0.55	1.48	27 770	1 x 328 ft
Z802331	KLFU-13-8	1/2"	1.54	0.69	2.49	47 166	1 x 328 ft
Z801146	KLFU-16-8	5/8"	1.89	0.85	3.90	709 69	1 x 328 ft
Z327377	KLFU-19-8	3/4"	2.24	1.06	5.38	100 062	1 x 328 ft
Z327385	KLFU-22-8	7/8"	2.60	1.18	7.39	134 444	1 x 164 ft
Z801505	KLFU-26-8	1"	3.07	1.38	9.95	189 544	1 x 164 ft

## Mid-Link Chain MLFU, Grade 8

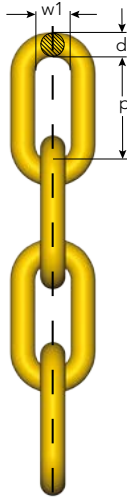

Heat treatment  
 Quenched and tempered,  
 Stress relieved

Surface treatment  
 Painted yellow

Not for lifting purposes

Art. no.	Code	Link dimensions			Weight lb/foot	Min. breaking load (lb)	Delivery length
		d nom.	P	w1			
Z802332	MLFU-10-8	3/8"	1.57	0.57	1.34	27 770	1 x 328 ft
Z802333	MLFU-13-8	1/2"	2.17	0.80	2.22	47 166	1 x 328 ft
Z800564	MLFU-16-8	5/8"	2.56	0.81	3.36	709 69	1 x 328 ft
Z800476	MLFU-19-8	3/4"	2.95	1.14	4.77	100 062	1 x 328 ft
Z800661	MLFU-22-8	7/8"	3.46	1.18	6.32	134 444	1 x 164 ft
Z801770	MFLU-26-8	1"	3.58	1.34	9.34	189 544	1 x 164 ft

## Long-Link Chain LLU, Grade 8

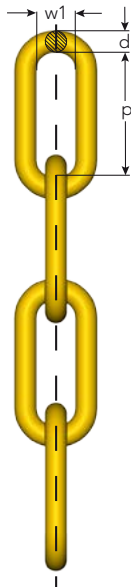

Heat treatment  
 Quenched and tempered,  
 Stress relieved

Surface treatment  
 Painted yellow

Not for lifting purposes

Art. no.	Code	Link dimensions			Weight lb/foot	Min. breaking load (lb)	Delivery length
		d	P	w1			
Z801934	LLU-9-8		2.09	0.56	0.02	22 481	4 x 328 ft
Z801935	LLU-11-8	7/16"	2.52	0.73	0.02	33 942	4 x 328 ft
Z801936	LLU-13-8	1/2"	3.15	0.83	0.03	47 166	3 x 328 ft
Z802160	LLU-16-8	5/8"	3.94	1.06	0.05	70 969	1 x 328 ft
Z601983	LLU-19-8	3/4"	3.94	1.06	0.08	100 062	1 x 328 ft
Z700526	LLU-22-8	7/8"	4.72	1.38	0.10	134 444	1 x 164 ft

## Short Link Chain - KLFZ, Grade 7

Heat treatment  
Quenched and tempered

Surface treatment  
Hot Dip Galvanized (HDG)

Not for lifting purposes

Art. No	Code	Link dimensions			Min. breaking load (lb)	Weight lb/foot	Delivery length
		d nom.	P	w1			
Z800666	KLFZ-10-7	3/8"	1.18	0.55	24 244	1.48	1 x 328 ft
Z802329	KLFZ-13-7	1/2"	1.54	0.68	39 672	2.49	1 x 328 ft
Z801644	KLFZ-16-7	5/8"	1.89	0.85	61 712	3.90	1 x 328 ft
Z801409	KLFZ-17-7	17	1.89	0.91	66 120	4.30	1 x 328 ft
Z801407	KLFZ-19-7	3/4"	2.24	1.06	88 160	5.38	1 x 328 ft

Fulfills requirements in: EN 1461:2009 (Average surface thickness 3.35 mils)

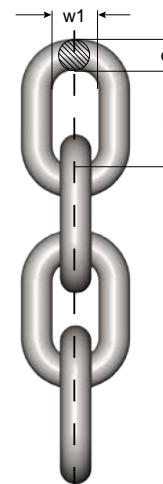

## Mid-Link Chain MLFZ, Grade 7

Heat treatment  
Quenched and tempered

Surface treatment  
Hot Dip Galvanized (HDG)

Not for lifting purposes

Art. No	Code	Link dimensions			Min. breaking load (lb)	Weight lb/foot	Delivery length
		d nom.	P	w1			
Z802455	MLFZ-10-6**	3/8"	1.57	0.57	22 040	1.34	1 x 328 ft
Z802335	MLFZ-13-7	1/2"	2.17	0.80	39 672	2.22	1 x 328 ft
Z801645	MLFZ-16-7	5/8"	2.56	0.81	61 712	3.36	1 x 328 ft
Z801477	MLFZ-19-7	3/4"	2.95	1.14	88 160	4.77	1 x 328 ft

Fulfills requirements in: EN 1461:2009 (Average surface thickness 3.35 mils)

\*\* Average surface thickness 2.75 mils

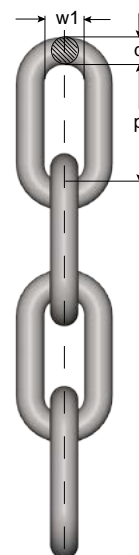

5

## Long Link Chain LLZ, Grade 6

Heat treatment  
Quenched and tempered

Surface treatment  
Hot Dip Galvanized (HDG)

Not for lifting purposes

Art. No	Code	Link dimensions			Min. breaking load (lb)	Weight lb/foot	Delivery length
		d nom.	P	w1			
Z802453	LLZ-9-6**	6/16"	2.09	0.56	17 191	0.94	1 x 328 ft
Z802454	LLZ-11-6**	7/16"	2.52	0.73	25 566	1.41	4 x 328 ft
Z800682	LLZ-13-6	1/2"	3.15	0.83	35 925	1.95	3 x 328 ft
Z802207	LLZ-13-6	1/2"	3.15	0.83	35 925	1.95	1 x 750 ft
Z801567	LLZ-16-6	5/8"	3.94	1.06	54 439	3.09	1 x 328 ft
GS1073	LLZ-16-6	5/8"	3.94	1.06	54 439	3.09	1 x 656 ft
Z801458	LLZ-19-6	3/4"	3.94	1.06	76 699	4.37	1 x 390 ft
Z801887	LLZ-22-6	7/8"	4.72	1.38	102 706	5.85	1 x 164 ft
Z802447	LLZ-25-6	1"	5.51	1.54	132 240	8.07	1 x 164 ft

Fulfills requirements in: EN 1461:2009 (Average surface thickness 3.35 mils)

\*\* Average surface thickness 2.75 mils

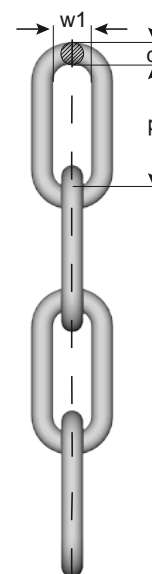

# Technical Information

## Chain Manufacturing - Quality and Strength Requirements

Chains are divided into grades based on minimum nominal breaking stress.

Chain Grade	Surface treatment	Code	Minimum breaking stress N/in <sup>2</sup>	Minimum breaking stress N/mm <sup>2</sup>	Mean breaking stress "ksi"	Load factors			Typical use
						WLL	MPF	Breaking force	
8	Yellow U Black B	KL	31.50	800	116	1	2.5	4	General lifting (KL), Container lashing (LL), Extra heavy towing (ML), Lashing (KL, LL), Fishing (KL, ML, LL)
		ML	31.50	800	116	-	1	4	
		LL	31.50	800	116	-	1	4	
10	Blue A	KL	39.37	1000	145	1	2.5	4	General lifting

### Testing and Quality Control- GrabiQ & Classic Chain (Grade 10 & 8)

In each step of the manufacturing of the chain, our systematic quality monitoring will ensure the highest safety and the longest life span in the product. Here are some especially important aspects of quality:

#### Material

The incoming material is supplied with test certificates only from qualified manufacturers and according to our stated material specifications.

#### Manufacturing

During forming and welding, the operators continuously control that the links meet the specified dimensions both before and after welding.

Single link samples are continuously mandrel tested on the weld. Shape, dimensions and deburring are then inspected visually.

Sample lengths are heat treated and then destruction load tested. Following these tests, the chain is heat treated.

Hardening and tempering is carried out continuously in computer controlled induction furnaces with regular samplings.

#### Proof Force

The entire chain is test loaded. The manufacturing proof force for short link chain is 2.5 times the permitted working load limit. This gives the chain high safety in use. The chain is then visually inspected and cut into delivery lengths. A sample is taken from every length and tested to destruction. Dimensions and shape are also checked. All results are documented.

#### Marking and Traceability

The international standards for lifting chain require that the chain is marked with Grade and Manufacturers ID. On our chain we stamp "SWE - 10G - H - 10G - 4", where the "H" and the "4" is the combination for the traceability code. In case of the unlikely event of chain failure, we can trace the specific chain link back to the very batch and raw material as well as the year and place of manufacture. Each individual delivery length also has its unique batch number.

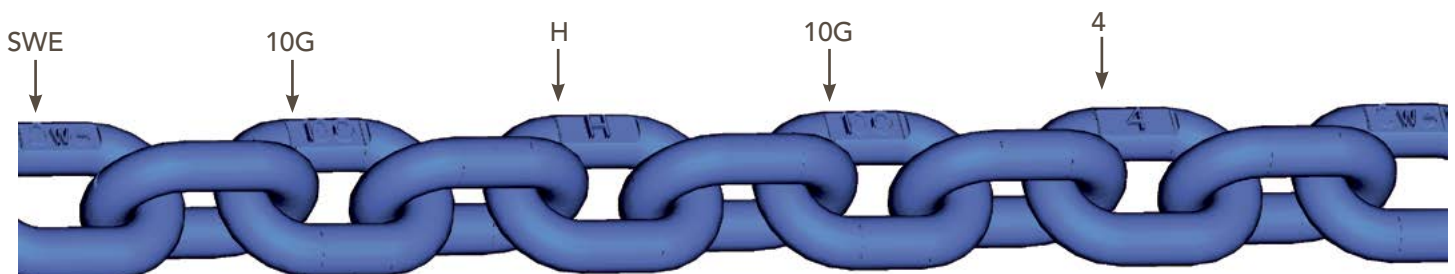

## Use

- Never lift with a twisted chain.
- Use shortening hooks, knotting is not allowed.
- Use edge protectors to prevent sharp edges from damaging the chain.

See website or user instructions for assembly instructions.

Meets listed current specifications and standards at time of publication of this catalogue.

## Maintenance

Periodic thorough examination must be carried out at least every 12 months or more frequently according to local statutory regulations, type of use and past experience.

1. Overloaded chain slings must be taken out of service.
2. Chain and components including load pins which have been damaged, deformed, elongated, bent or showing signs of cracks or gouges shall be replaced. Carefully grind away small nicks and burrs.
3. Additional testing by magnetic particle inspection and/or proof loading at max. 2 x WLL may be carried out. The wear of the chain and component shall in no place exceed 10% of the original dimensions.
4. The chain link wear - max. 10% - is defined as the reduction of the mean diameter measured in two directions.

## Severe Environment

Chain and components must not be used in alkaline (>pH10) or acidic conditions (<pH6). Comprehensive and regular examination must be carried out when used in severe or corrosive inducing environments. In uncertain situations consult your Gunnebo Industries dealer.

## Extreme Temperature Conditions

The in service temperature effects the WLL as following :

Temperature (°F)	Reduction of WLL			
	Grade 10 chain (400)	Grade 10 chain (200)	Grade 10 components	Grade 8 chain & components
-40 to +392 °F	0 %	0 %	0 %	0 %
+392 to +572 °F	10 %	Not allowed	10 %	10 %
+572 to +752 °F	25 %	Not allowed	25 %	25 %

After short heat exposure, maximum one hour, the sling reverts to its full capacity. Upon return to normal temperature, the sling reverts to its full capacity within the above temperature range. Chain slings should not be used above or below these temperatures.

**For chain grade 10(200) the maximum in service temperature is 392° C.**

## Definitions

### Proof force:

Each individual chain link is tested to the Manufacturing Proof Force (MPF) level before delivery. The MPF level is 2.5 times the WLL, equal to 62.5% of the Minimum Breaking Force.

### Breaking force (BF):

The highest static force a chain is exposed to during test loading before breaking.

### Working load limit (WLL):

The maximum permitted load on a lifting chain under normal (vertical) lifting conditions.

### Total ultimate elongation:

The elongation of the test item, relative to the original length, at the moment of breaking.

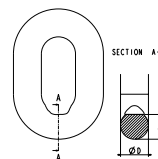

$$\frac{D+d}{2} > 0.9d_n$$

# Johnson Blocks

Crane Blocks • Snatch Blocks • Oilfield Blocks • Swivels  
• Custom Engineered Products •



**GUNNEBO**  
Industries

**JOHNSON**



<b>Crane Blocks</b>	6:2 - 6:14
Quick Reeve Crane Block	6:2
Shorty "J" Crane Block	6:3
<b>Overhaul Balls</b>	6:15 - 6:17
Top Swivel Overhaul Ball	6:15
Top-Swivel Overhaul Ball with BK Hook	6:17
Non-Swivel Overhaul Ball	6:17
<b>Swivels</b>	6:18 - 6:21
<b>Wedge Sockets</b>	6:22
<b>Snatch Blocks</b>	6:23 - 6:26
Snatch Block - Tailboard	6:23
Snatch Block – Shackle	6:24
Snatch Block – Hook	6:24
Snatch Block – Others (page 6:29)	6:25
Tilt Wall Block	6:26
<b>Oilfield Blocks</b>	6:27 - 6:30
Tubing Block	6:27
Manhandler Block	6:28
Derrick Block	6:28
Laydown Block	6:29
Tong Line Block	6:30
Hay Fork Pulley	6:30
Guyline Block	6:30
<b>J-Latches</b>	6:31
<b>Technical Information</b>	6:32 - 6:43
General Precautions	6:32
Inspection and Maintenance	6:36
Warnings and Use Limitations	6:38

**WARNING:**  
Failure to read, understand and comply with the instructions, working load limits and specifications in this publication may result in serious injury or damage to property.

## Johnson Blocks

With 50 years of excellence and industry leadership, Johnson Blocks has deep roots in the oilfield and the OEM crane industries. Our crane blocks are dominant in the North American lifting industry and the benefits of using Johnson blocks are many; with a proven record of engineering innovations and dependability, we have provided blocks all over the world for decades, always delivered with the highest quality, providing our customers a peace of mind.



### Quick Reeve - Mobile Crane Block



#### Standard Features

- Quick release, zinc plated, rope retention pin meets OSHA requirements for rope retention. Cannot be completely removed from block to avoid pin loss.
- J-Latch™ is standard equipment for blocks up to 250 short tons. Larger blocks are equipped with standard bar latches.
- Johnson J-Latch™ heavy duty, steel, lockable, spring loaded latch meets OSHA personnel lifting requirements.
- The Johnson J-Latch™ provides a fast hook deformation inspection point.
- Quick Reeve™ upright design rests on its own hook for a stable base while reeving.
- No bulky, drop down, trap door to handle or damage.
- Wire rope end fitting will pass through block without removal from wire rope.
- 5 – 330 short tons capacity
- 4:1 design factor
- 1, 2, 3, 5 or 7 sheaves
- 10" - 30" sheave diameters
- Reeving pins for all models
- Roller bearing sheaves
- Direct-channel sheave bearing lubrication through center pin
- Flame hardened grooves on sheave sizes 16" - 24" in diameters
- Dual action (swing/swivel) roller thrust bearing hooks
- Forged steel hooks, up to 30 short tons
- Total disassembly possible
- Meet ASME 30.5 standard

#### Optional Features

- Forged steel hooks, 35 - 300 short tons
- Duplex hooks available from 25 short tons
- Anti-rotation hook locking devices, all models
- Swivel safety anchor shackles, all models
- Center top dead end available for blocks with 3 sheaves or less
- Sheave shrouds, all models
- All weighted models have detachable cheek weights in cast iron or steel
- Proof test and certification, radiographic, magnetic particle, and other non-destructive testing to specification by customer
- Bronze bushings available
- Other sheave combinations available
- Can be manufactured to API, Lloyd's, DNV, ABS, CCS and CE

## Shorty "J" Crane Blocks

Shorty "J" represents the broadest line of standard crane blocks in the industry. In all, we manufacture more than 1500 standard models of crane blocks not including options.

### Standard Features

- 10 - 325 short tons capacity
- 4:1 design factor
- 1, 2, 3, 5 or 7 sheaves
- 12" - 24" in sheave diameters
- Roller bearing sheaves
- Direct-channel sheave bearing lubrication through centre pin
- Flame hardened grooves on sheave sizes 16" - 24" in diameters
- Dual action (swing/swivel) roller thrust bearing hooks
- Forged steel hooks, up to 30 short tons
- J-Latch™ is standard equipment for blocks up to 250 short tons. Larger blocks are equipped with standard bar latches
- Johnson J-Latch™ heavy duty, steel, lockable, spring loaded latch meets OSHA personnel lifting requirements.
- The Johnson J-Latch™ provides a fast hook deformation inspection point.
- Meet ASME 30.5 standard

### Optional Features

- Forged steel single barb hooks, 35 - 300 short tons
- Duplex hooks available from 25 short tons
- Anti-rotation hook locking devices, all models
- Swivel safety anchor shackles, all models
- Sheave shrouds, all models
- All weighted models have detachable cheek weights in cast iron or steel
- Bronze bushings available
- Other sheave combinations available
- Proof test and certification, radiographic, magnetic particle, and other non-destructive testing to specification by customer
- Can be manufactured to API, Lloyd's, DNV, ABS, CCS, CMAA and CE



## Fixed Bail Construction and Marine Rigging Blocks

Beginning with 100 standard models, you are assured of selections that fit your every need. The lowest weight to capacity ratios, the quickest rigging and the easiest maintenance are a few additional benefits that prove once again that Johnson Blocks are consistent in quality and value.

### Standard Features

- 10 to 135 short tons
- 4:1 design factor
- 1 to 6 sheaves
- Full coverage side plates and center plates
- Top dead-end shackle
- Tapered roller bearings
- Oval pattern side plates

### Optional Features

- Bronze bushings
- Diamond pattern side plates
- Fully galvanized for corrosion resistance
- High capacity, custom engineered blocks available upon request



6

# One Sheave Shorty "J" Crane Blocks

Design Factor 4:1

For crane block warnings and use limitations see pages: 6:42 and 6:43

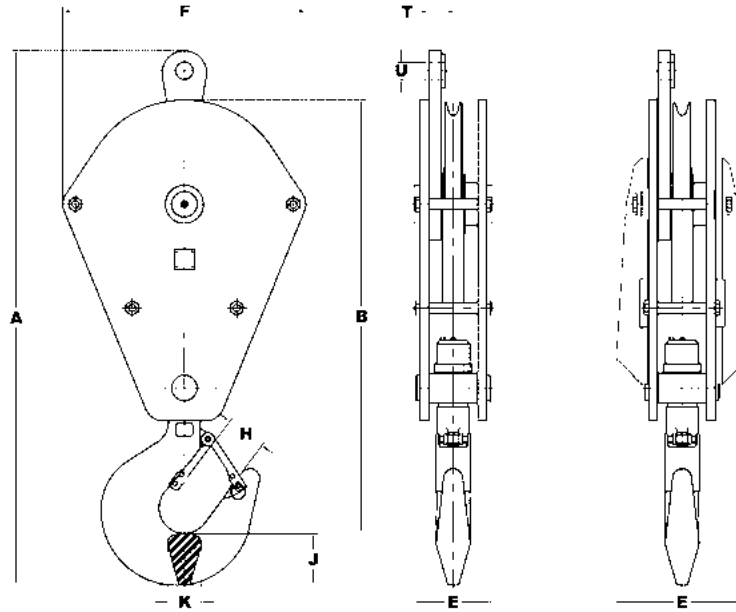

## 12-inch 1-Sheave Shorty "J" Crane Blocks, 10-20 short tons, 3/8" to 9/16" or 10mm to 15mm

Model	WLL	Wt.	A Overall Length	B Net Length	E Thickness	F Width	H Throat Opening w/Latch	J Hook Thick.	K Hook Width
J-10S12RTB	10	270	32.5	26.25	9.687	16	1.91	2.53	1.93
J-15S12RTB	15	263	32.5	26.25	9.687	16	1.91	2.53	1.93
J-20S12RTB	20	323	37.875	30.5	10.187	16	3.5	3	2.38

Model	WLL	Wt.	A Overall Length	B Net Length	E Thickness	F Width	H Throat Opening w/Latch	J Hook Thick.	K Hook Width	T Deadend Thick.	U Hole Dia.
-------	-----	-----	------------------	--------------	-------------	---------	--------------------------	---------------	--------------	------------------	-------------

## 16-inch 1-Sheave Shorty "J" Crane Blocks, 15-30 short tons, 5/8" to 3/4" or 16mm to 19mm

J15S16RTB	15	371	37.375	30.25	9.562	20.125	1.91	2.625	1.937	1.37	1.65
J20S16RTB	20	434	42.75	34.5	10.062	20.125	2.8	3.75	3	1.37	1.65
J20S16RTB	20	434	42.75	34.5	10.062	20.125	2.8	3.75	3	1.37	1.65
J30S16RTB	30	447	45.25	36.5	10.062	20.125	3.28	3.5	3	1.5	1.65

## 20-inch 1-Sheave Shorty "J" Crane Blocks, 25-40 short tons, 7/8" to 1" or 22mm to 26mm

J25S20RTB	25	734	49.75	40.875	11.437	24.75	3.28	3.75	3	1.5	2.06
J30S20RTB	30	748	50.25	41.375	11.437	24.75	3.28	3.5	3	1.5	2.06
J40S20RTB	40	947	59	46.875	12.187	24.75	3.27	4.25	3.38	1.75	2.28

## 24-inch 1-Sheave Shorty "J" Crane Blocks, 30-55 short tons, 1-1/8" or 29mm

J30S24RTB	30	1251	54	45.125	14.687	28.75	3.28	3.5	3	1.5	2.06
J40S24RTB	40	1472	60.875	50.875	15.562	28.75	3.27	4.25	3.375	1.75	2.28
J55S24RTB	55	1556	65.25	53.25	15.562	28.75	4.63	6.13	4	2	2.53

## Two Sheave Shorty "J" Crane Blocks

Design Factor 4:1

For crane block warnings and use limitations see pages: 6:42 and 6:43

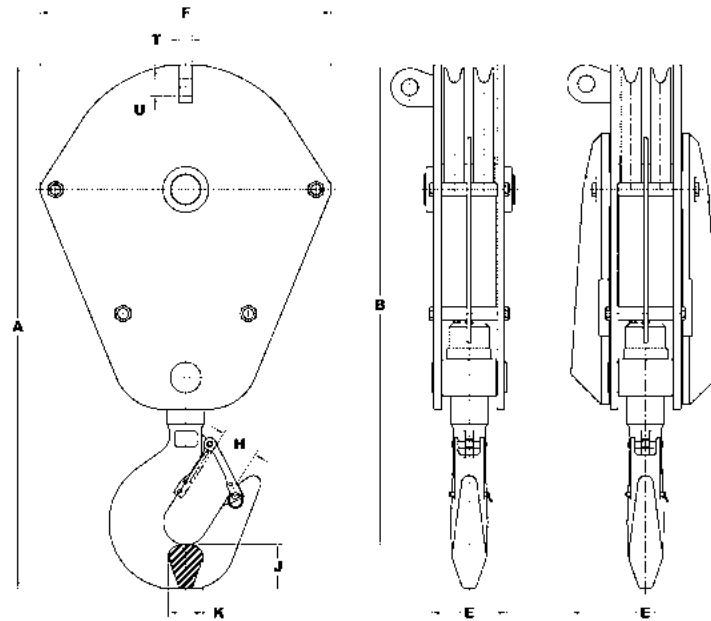

Model	WLL	Wt.	A Overall Length	B Net Length	E Thickness	F Width	H Throat Opening w/Latch	J Hook Thick.	K Hook Width
<b>12-inch 2-Sheave Shorty "J" Crane Blocks, 10-25 short tons, 3/8" to 9/16" or 10mm to 15mm</b>									
J-10D12RTB	10	285	28.875	26.25	9.687	16	1.91	2.53	1.93
J-15D12RTB	15	290	28.875	26.25	9.687	16	1.91	2.53	1.93
J-20D12RTB	20	345	34.25	30.5	10.187	16	2.8	3	2.38
J-25D12RTB	25	345	34.25	30.5	10.187	16	2.8	3	2.38
<b>16-inch 2-Sheave Shorty "J" Crane Blocks, 20-30 short tons, 5/8" to 3/4" or 16mm to 19mm</b>									
J-20D16RTB	20	484	38.25	34.5	10.062	20.125	2.8	3	2.38
J-25D16RTB	25	484	38.25	34.5	10.062	20.125	2.8	3	2.38
J-30D16RTB	30	506	40.25	36.5	10.062	20.125	3.28	3.5	3
<b>20-inch 2-Sheave Shorty "J" Crane Blocks, 25-55 short tons, 7/8" to 1" or 22mm to 26mm</b>									
J-25D20RTB	25	820	44.625	40.875	11.437	24.75	3.28	3	2.38
J-30D20RTB	30	834	45.125	41.375	11.437	24.75	3.28	3.5	3
J-40D20RTB	40	1047	51.125	46.875	12.312	24.75	3.27	4.25	3.38
J-55D20RTB	55	1123	55.5	49.375	12.312	24.75	4.63	6.13	4
<b>24-inch 2-Sheave Shorty "J" Crane Blocks, 40-70 short tons, 1-1/8" or 29mm</b>									
J40D24RTB	40	1617	55.125	50.875	15.562	28.75	3.27	4.25	3.38
J55D24RTB	55	1692	59.375	53.25	15.562	28.75	4.63	6.13	4
J70D24RTB	70	1700	59.625	53.375	15.562	28.75	4.36	6.25	4.5

6

## Three Sheave Shorty "J" Crane Blocks

Design Factor 4:1

For crane block warnings and use limitations see pages: 6:42 and 6:43

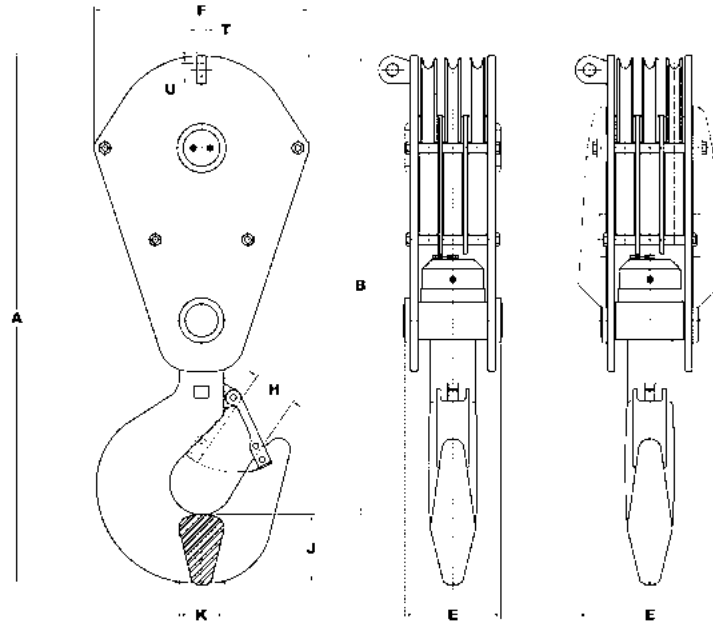

Model	WLL	Wt.	A Overall Length	B Net Length	E Thickness	F Width	H Throat Opening w/Latch	J Hook Thick.	K Hook Width
-------	-----	-----	------------------------	--------------------	----------------	------------	-----------------------------------	---------------------	--------------------

### 12-inch 3-Sheave Shorty "J" Crane Blocks, 15-30 short tons, 3/8" to 9/16" or 10mm to 15mm

J-15T12RTB	15	325	27.375	24.75	12	16	1.91	2.53	1.93
J-20T12RTB	20	380	29.75	26.75	12.5	16	2.8	3	2.38
J-25T12RTB	25	380	29.75	26.75	12.5	16	2.8	3	2.38
J-30T12RTB	30	425	35	31.25	12.5	16	3.28	3.5	3

### 16-inch 3-Sheave Shorty "J" Crane Blocks, 25-40 short tons, 5/8" to 3/4" or 16mm to 19mm

J25T16RTB	25	544	33.75	30.75	12.375	20.125	2.8	3	2.38
J30T16RTB	30	593	40	36.25	12.375	20.125	3.28	3.5	3
J40T16RTB	40	661	45.25	41	12.375	20.125	3.27	4.25	3.38

### 20-inch 3-Sheave Shorty "J" Crane Blocks, 30-80 short tons, 7/8" to 1" or 22mm to 26mm

J30T20RTB	30	976	42.125	38.375	14.375	24.75	3.28	3.5	3
J40T20RTB	40	1169	51.125	46.875	14.375	24.75	3.27	4.25	3.38
J55T20RTB	55	1250	55.5	49.375	14.375	24.75	4.63	6.13	4
J60T20RTB	60	1250	55.5	49.375	14.375	24.75	4.63	6.13	4
J70T20RTB	70	1282	55.75	49.5	14.375	24.75	4.36	6.25	4.5
J80T20RTB	80	1492	60	53	15.625	24.75	4.75	6.75	4.75

### 24-inch 3-Sheave Shorty "J" Crane Blocks, 55-100 short tons, 1-1/8" or 29mm

J55T24RTB	55	1851	59.375	53.25	18.125	28.75	4.63	6.13	4
J60T24RTB	60	1851	59.375	53.25	18.125	28.75	4.63	6.13	4
J70T24RTB	70	1884	59.625	53.375	18.125	28.75	4.36	6.25	4.5
J80T24RTB	80	2077	64	57	18.875	28.75	4.75	6.75	4.75
J90T24RTB	90	2357	65.125	57.5	19.375	28.75	4.77	7.63	5.5
J100T24RTB	100	2357	65.125	57.5	19.375	28.75	4.77	7.63	5.5

## Five Sheave Shorty "J" Crane Blocks

Design Factor 4:1

For crane block warnings and use limitations see pages: 6:42 and 6:43

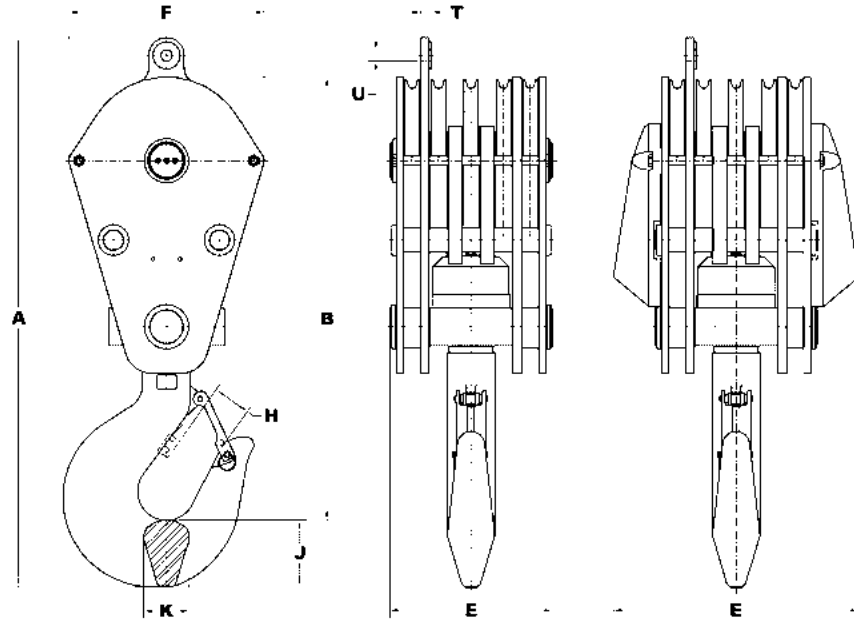

Model	WLL	Wt.	A Overall Length	B Net Length	E Thickness	F Width	H Throat Opening w/Latch	J Hook Thick.	K Hook Width
-------	-----	-----	------------------------	--------------------	----------------	------------	-----------------------------------	---------------------	--------------------

### 12-inch 5-Sheave Shorty "J" Crane Blocks, 25-30 short tons, 3/8" to 9/16" or 10mm to 15mm

J-25QN12RTB	25	466	34.75	27.75	17.062	16	2.8	3	2.38
J-30QN12RTB	30	495	39.125	31.25	17.062	16	3.28	3.5	3

### 16-inch 5-Sheave Shorty "J" Crane Blocks, 30-80 short tons, 5/8" to 3/4" or 16mm to 19mm

J30QN16RTB	30	753	44.25	36.25	16.937	20.125	3.28	3.5	3
J40QN16RTB	40	821	48.75	40.25	16.937	20.125	3.27	4.25	3.38
J50QN16RTB	50	998	53.875	43.625	17.562	20.125	4.63	6.13	4
J55QN16RTB	55	998	53.875	43.625	17.562	20.125	4.63	6.13	4
J70QN16RTB	70	1044	55.25	43.375	21.937	20.125	4.36	6.25	4.5
J80QN16RTB	80	1379	62	49.625	22.437	20.125	4.75	6.75	4.75

### 20-inch 5-Sheave Shorty "J" Crane Blocks, 55-100 short tons, 7/8" to 1" or 22mm to 26mm

J55QN20RTB	55	1737	61.25	49.625	21.937	24.75	4.63	6.13	4
J70QN20RTB	70	1770	61.5	49.625	21.937	24.75	4.36	6.25	4.5
J80QN20RTB	80	1785	65.625	53	22.687	24.75	4.75	6.75	4.75
J90QN20RTB	90	2128	66.5	53.625	22.687	24.75	4.77	7.63	5.5
J100QN20RTB	100	2128	66.5	53.625	22.687	24.75	4.77	7.63	5.5

### 24-inch 5-Sheave Shorty "J" Crane Blocks, 200 short tons, 1-1/8" or 29mm

J-200QN24RTB	200	5501	87	71	31.187	28.75	9.01	10.13	6
--------------	-----	------	----	----	--------	-------	------	-------	---

## Seven Sheave Shorty "J" Crane Blocks

Design Factor 4:1

For crane block warnings and use limitations see pages: 6:42 and 6:43

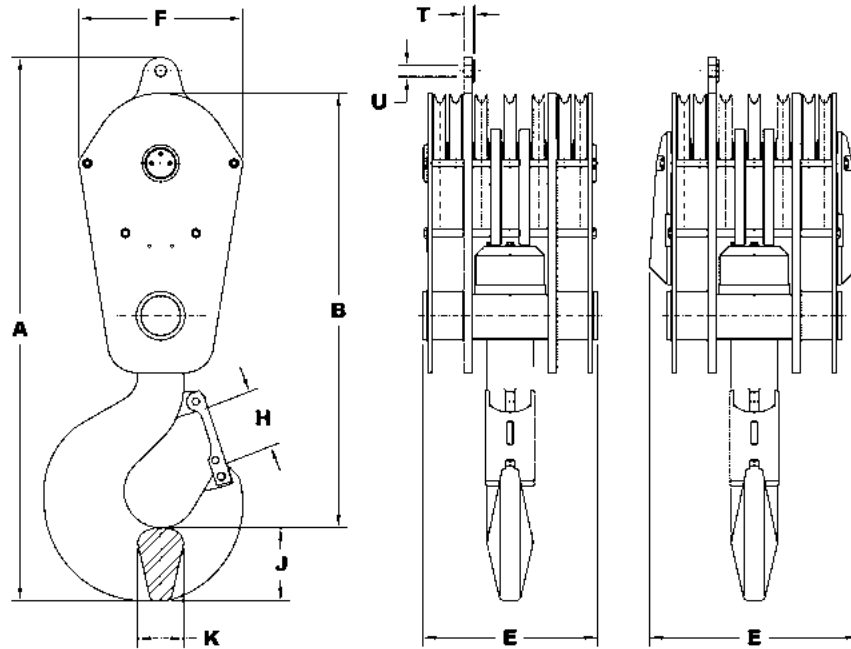

Model	WLL	Wt.	A Overall Length	B Net Length	E Thickness	F Width	H Throat Opening w/Latch	J Hook Thick.	K Hook Width
-------	-----	-----	------------------------	--------------------	----------------	------------	-----------------------------------	---------------------	--------------------

### 24-inch 7-Sheave Shorty "J" Crane Blocks, 250-325 short tons, 1-1/8" or 29mm

J-250SV24RTB	250	6279	95.375	76.25	36.75	28.75	8.52	12.81	8
J-265SV24RTB	265	6279	95.375	76.25	36.75	28.75	8.52	12.81	8
J-300SV24RTB	300	7149	95.25	76.75	38.875	28.75	9.13	12.73	9
J-325SV24RTB	325	7149	95.25	76.75	38.875	28.75	9.13	12.73	9



## Quick Reeve Crane Blocks™

Design Factor 4:1

For crane block warnings and use limitations see pages: 6:42 and 6:43

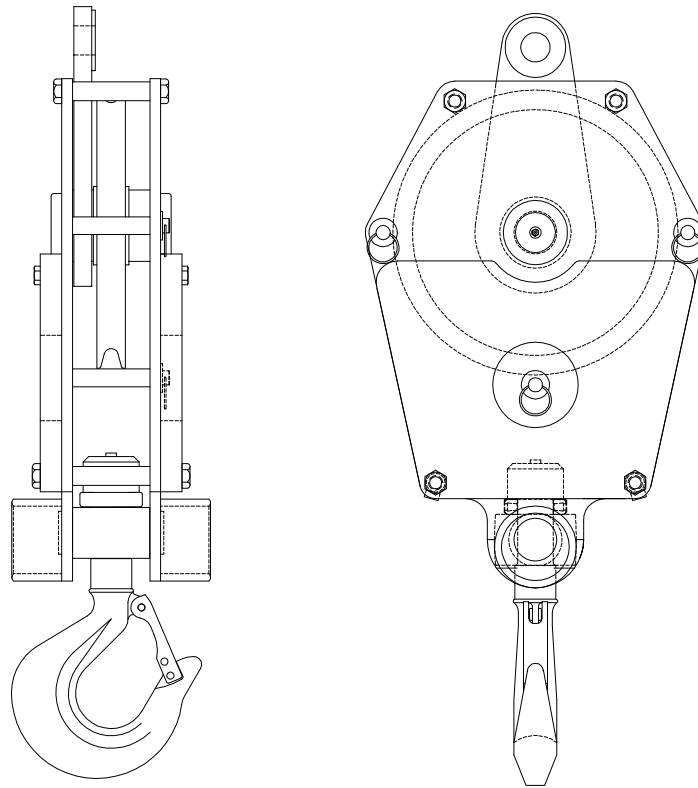

Model number	Working Load Limit (short tons)	Number of Sheaves	Sheave Diameter	Weight (lb.)
<b>12-inch 1-Sheave QRJ Blocks, 10-15 short tons, 3/8" to 9/16" or 10mm to 15mm</b>				
QRJ10S12RTB	10	1	12	270
QRJ15S12RTB	15	1	12	263
<b>16-inch 1-Sheave QRJ Blocks, 10-20 short tons 5/8" to 3/4" or 16mm to 19mm</b>				
QRJ10S16RTB	10	1	16	472
QRJ20S16RTB	20	1	16	434
<b>20-inch 1-Sheave QRJ Blocks, 20-30 short tons 7/8" to 1" or 22mm to 26mm</b>				
QRJ20S20RTB	20	1	20	734
QRJ25S20RTB	25	1	20	734
QRJ30S20RTB	30	1	20	748
<b>24-inch 1-Sheave QRJ Block, 30 short tons 1-1/8" or 29mm</b>				
QRJ30S24RTB	30	1	24	1310

# Quick Reeve Crane Blocks™

Design Factor 4:1

For crane block warnings and use limitations see pages: 6:42 and 6:43

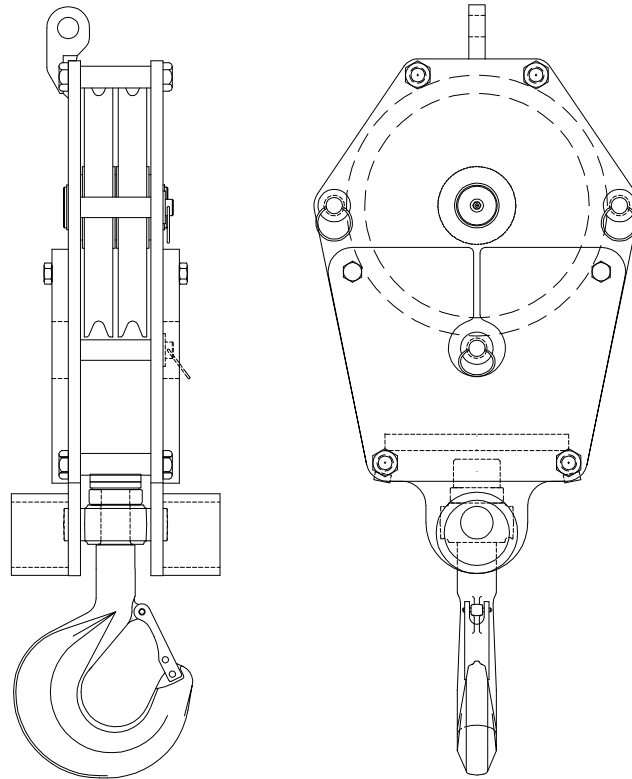

Model number	Working Load Limit (short tons)	Number of Sheaves	Sheave Diameter	Weight (lb.)
--------------	---------------------------------	-------------------	-----------------	--------------

### 12-inch 2-Sheave QRJ Blocks, 15-25 short tons 3/8" to 9/16" or 10mm to 15mm

QRJ15D12RTB	15	2	12	290
QRJ20D12RTB	20	2	12	345
QRJ25D12RTB	25	2	12	345

### 16-inch 2-Sheave QRJ Blocks, 15-40 short tons 5/8" to 3/4" or 16mm to 19mm

QRJ15D16RTB	15	2	16	410
QRJ20D16RTB	20	2	16	484
QRJ25D16RTB	25	2	16	484
QRJ30D16RTB	30	2	16	506
QRJ40D16RTB	40	2	16	581

## Quick Reeve Crane Blocks™

Design Factor 4:1

For crane block warnings and use limitations see pages: 6:42 and 6:43

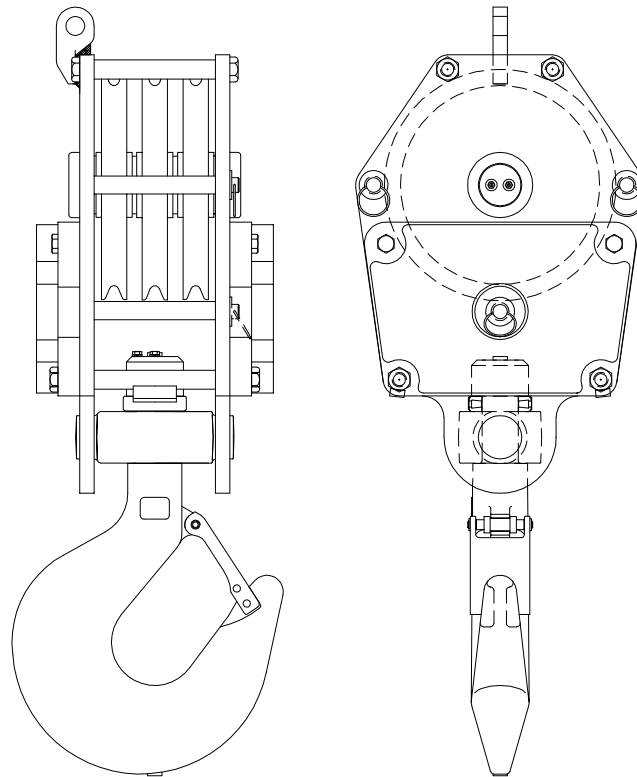

Model number	Working Load Limit (short tons)	Number of Sheaves	Sheave Diameter	Weight (lb.)
<b>12-inch 3-Sheave QRJ Blocks, 15-30 short tons, 3/8" to 9/16" or 10mm to 15mm</b>				
QRJ15T12RTB	15	3	12	325
QRJ20T12RTB	20	3	12	380
QRJ25T12RTB	25	3	12	380
QRJ30T12RTB	30	3	12	425
<b>16-inch 3-Sheave QRJ Blocks, 25-50 short tons, 5/8" to 3/4" or 16mm to 19mm</b>				
QRJ25T16RTB	25	3	16	544
QRJ30T16RTB	30	3	16	593
QRJ40T16RTB	40	3	16	661
QRJ50T16RTB	50	3	16	734
<b>20-inch 3-Sheave QRJ Block, 50 short tons, 7/8" to 1" or 22mm to 26mm</b>				
QRJ50T20RTB	50	3	20	1250

## Quick Reeve Crane Blocks™

Design Factor 4:1

For crane block warnings and use limitations see pages: 6:42 and 6:43

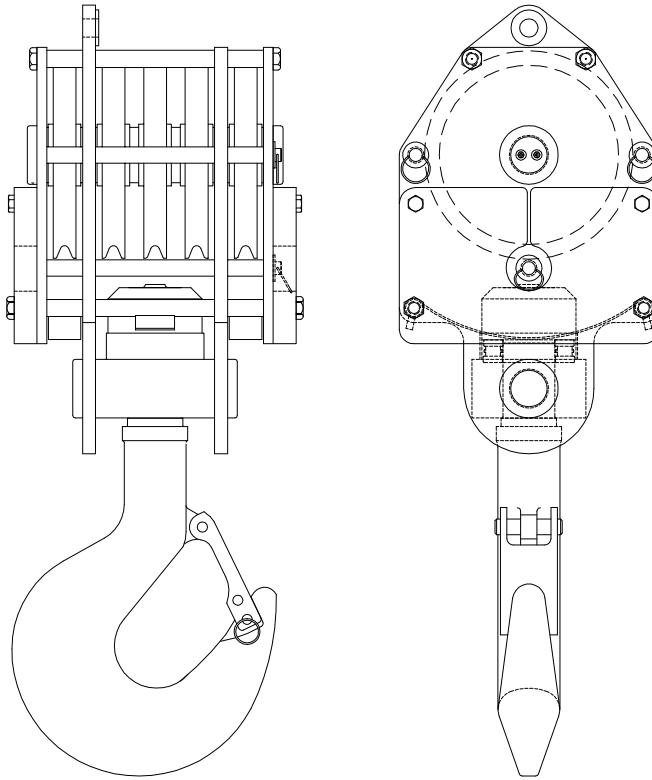

Model number	Working Load Limit (short tons)	Number of Sheaves	Sheave Diameter	Weight (lb.)
<b>16-inch 5-Sheave QRJ Blocks, 40-80 short tons, 5/8" to 3/4" or 16mm to 19mm</b>				
QRJ40QN16RTB	40	5	16	821
QRJ50QN16RTB	50	5	16	998
QRJ70QN16RTB	70	5	16	1044
QRJ80QN16RTB	80	5	16	1379
<b>20-inch 5-Sheave QRJ Blocks, 70-100 short tons, 7/8" to 1" or 22mm to 26mm</b>				
QRJ70QN20RTB	70	5	20	1770
QRJ80QN20RTB	80	5	20	1785
QRJ90QN20RTB	90	5	20	2128
QRJ100QN20RTB	100	5	20	2128
<b>24-inch 5-Sheave QRJ Blocks, 90-100 short tons, 1-1/8" or 29mm</b>				
QRJ90QN24RTB	90	5	24	2892
QRJ100QN24RTB	100	5	24	2892

## Quick Reeve Crane Blocks™

Design Factor 4:1

For crane block warnings and use limitations see pages: 6:42 and 6:43

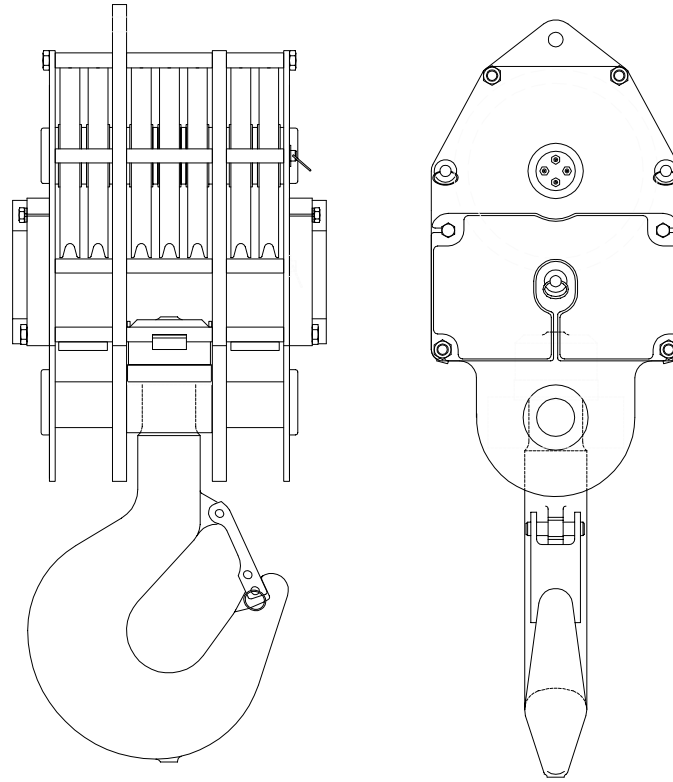

Model number	Working Load Limit (short tons)	Number of Sheaves	Sheave Diameter	Weight (lb.)
--------------	---------------------------------	-------------------	-----------------	--------------

**20-inch 7-Sheave QRJ Blocks, 100-140 short tons, 7/8" to 1" or 22mm to 26mm**

QRJ100SV20RTB	100	7	20	2600
QRJ140SV20RTB	140	7	20	3097

## Overhaul Balls

Provide the overhaul weight necessary to counter bearing friction and winch-to-boom-tip line weight. Because these units must meet a wide range of field applications, we offer an equally wide range of unit sizes. It is in fact, one of the widest ranges available. Over 240 models; 3 - 25 metric tonnes WLL. Non-swivel balls are also available.

### Standard Features

- 3 to 25 metric tonnes
- 4:1 design factor
- Heavy duty J-Latch standard

### Optional Features

- High capacity, custom engineered balls available upon request.



Split Ball    Non-Swivel    Top Swivel    Bottom Swivel    Gunnebo Industries BK Safety Hook

## Split Overhaul Ball

Design Factor 4:1

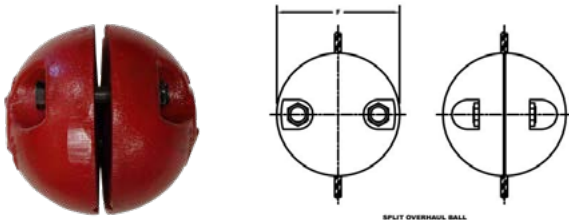

Art.no.	Model No.	Weight lb	Wire Rope Size	F Ball Dia.
452245	OB 50 SPLIT	50	Suits 1/2" - 7/8" in (13-22 mm) wire rope	7.24
452179	OB 100 SPLIT	100	Suits 5/8" - 7/8" in (16-22 mm) wire rope	9.25

## Top Swivel Overhaul Ball 3 - 25 metric tonnes

Design Factor 4:1

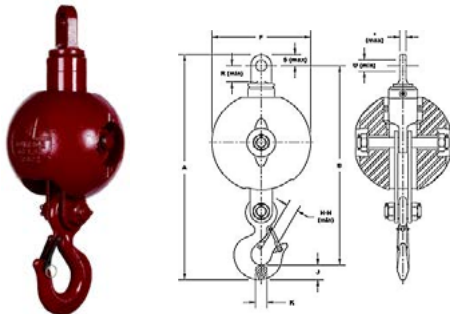

Key to Top Swivel Overhaul Ball Model Numbers:

- OB - Overhaul Ball
- 4EE - Swivel Model
- 85 - Ball Weight (lb)
- 4 - Type

To order please specify the model number.

Art.no.	Model No.	WLL metric tonnes	Weight of Assembly lb	A Overall Length	B Net Length	F Ball Dia.	H Throat Opening	J Hook Thickness	K Hook Width	R Pin to Obstruction	S Pin to End of Fitting	T Thickness of Eye	U Hole Dia.
471995	OB3JEM28-4	3	38	13.46	10.65	7.94	1.10	1.44	1.12	1.23	1.22	0.91	1.09
471538	OB4EE35-4	4	59	23.59	20.06	7.50	1.10	1.44	1.12	1.55	1.34	1.03	1.34
471539	OB7EE35-4	7	63	24.50	21.44	7.50	1.38	1.81	1.46	1.55	1.34	1.03	1.34

471539	OB7EE35-4	7	63	24.50	21.44	7.50	1.38	1.81	1.46	1.55	1.34	1.03	1.34
471541	OB7EE85-4	7	102	24.59	21.44	9.50	1.38	1.81	1.46	1.55	1.34	1.03	1.34
471545	OB7EE150-4	7	171	27.25	24.10	11.25	1.38	1.81	1.46	1.55	1.34	1.03	1.34
471550	OB12EE200-4	12	248	34.03	29.41	12.00	1.82	2.59	1.94	2.24	2.03	1.28	1.78
471861	OB12EE285-4	12	360	34.03	29.41	13.88	1.82	2.59	1.94	2.24	2.03	1.28	1.81
471552	OB12EE350-4	12	404	34.03	29.41	14.50	1.82	2.59	1.94	2.24	2.03	1.28	1.81
473734	OB19EE350-4	19	435	37.51	32.48	14.50	2.80	3.00	2.38	2.43	2.03	1.28	1.81
473735	OB19EE650-4	19	733	39.51	34.48	17.94	2.80	3.00	2.38	2.43	2.03	1.28	1.81
473738	OB25EE650-4	25	764	41.04	35.54	17.94	2.80	3.00	2.38	2.78	2.51	1.66	2.10
473739	OB25EE1150-4	25	1253	41.04	35.54	21.63	2.80	3.00	2.38	2.78	2.51	1.66	2.10

Model no.	Working Load Limit (short tons)	Weight of Assembly lb	A Overall Length	B Net Length	F Ball Dia.	H Throat Opening with Latch	J Hook Thickness	K Hook Width	R Pin to Obstruction	S Pin to End of Fitting	T Thickness of Eye	U Hole Diameter
-----------	---------------------------------	-----------------------	------------------	--------------	-------------	-----------------------------	------------------	--------------	----------------------	-------------------------	--------------------	-----------------

## Type 4 Overhaul Ball, 7 short tons

OB 7EE 35-4	7	63	24.59	21.44	7.5	1.38	1.81	1.46	1.55	1.34	1.03	1.31
OB 7EE 85-4	7	100	24.59	21.44	9.5	1.38	1.81	1.46	1.55	1.34	1.03	1.31
OB 7EE 150-4	7	171	27.25	24.1	11.25	1.38	1.81	1.46	1.55	1.34	1.03	1.31
OB 7EE 200-4	7	210	27.25	24.1	12	1.38	1.81	1.46	1.55	1.34	1.03	1.31
OB 7EE 220-4	7	250	27.25	24.1	12.75	1.38	1.81	1.46	1.55	1.34	1.03	1.31
OB 7EE 285-4	7	318	27.25	24.1	13.88	1.38	1.81	1.46	1.55	1.34	1.03	1.31

## Type 4 Overhaul Ball, 12 short tons

OB 12EE 85-4	12	139	31.53	26.91	9.5	1.82	2.59	1.94	2.24	2.03	1.28	1.78
OB 12EE 150-4	12	209	34.03	29.41	11.25	1.82	2.59	1.94	2.24	2.03	1.28	1.78
OB 12EE 200-4	12	248	34.03	29.41	12	1.82	2.59	1.94	2.24	2.03	1.28	1.78
OB 12EE 220-4	12	288	34.03	29.41	12.75	1.82	2.59	1.94	2.24	2.03	1.28	1.78
OB 12EE 285-4	12	360	34.03	29.41	13.88	1.82	2.59	1.94	2.24	2.03	1.28	1.78
OB 12EE 350-4	12	396	34.03	29.41	14.5	1.82	2.59	1.94	2.24	2.03	1.28	1.78
OB 12EE 500-4	12	585	36.03	31.41	17.06	1.82	2.59	1.94	2.24	2.03	1.28	1.78
OB 12EE 650-4	12	703	36.03	31.41	17.94	1.82	2.59	1.94	2.24	2.03	1.28	1.78
OB 12EE1150-4	12	1171	36.03	31.41	21.63	1.82	2.59	1.94	2.24	2.03	1.28	1.78

## Type 4 Overhaul Ball, 19 short tons

OB 19EE 85-4	19	170	35.01	29.98	9.5	2.8	3	2.38	2.43	2.03	1.28	1.78
OB 19EE 150-4	19	240	37.51	32.48	11.25	2.8	3	2.38	2.43	2.03	1.28	1.78
OB 19EE 200-4	19	280	37.51	32.48	12	2.8	3	2.38	2.43	2.03	1.28	1.78
OB 19EE 350-4	19	435	37.51	32.48	14.5	2.8	3	2.38	2.43	2.03	1.28	1.78
OB 19EE 500-4	19	588	39.51	34.48	17.06	2.8	3	2.38	2.43	2.03	1.28	1.78
OB 19EE 650-4	19	733	39.51	34.48	17.94	2.8	3	2.38	2.43	2.03	1.28	1.78
OB 19EE1150-4	19	1201	39.51	34.48	21.63	2.8	3	2.38	2.43	2.03	1.28	1.78

## Type 4 Overhaul Ball, 25 short tons

OB 25EE 350-4	25	460	39.04	33.54	14.5	2.8	3	2.38	2.78	2.51	1.66	2.1
OB 25EE 500-4	25	638	41.04	35.54	17.06	2.8	3	2.38	2.78	2.51	1.66	2.1
OB 25EE 650-4	25	784	41.04	35.54	17.94	2.8	3	2.38	2.78	2.51	1.66	2.1
OB 25EE1150-4	25	1253	41.04	35.54	21.63	2.8	3	2.38	2.78	2.51	1.66	2.1

## Type 4 Overhaul Ball, 30 short tons

OB 30EE 650-4	30	872	49.22	41.77	17.94	3.0	4.56	3.75	2.79	2.88	1.63	2.28
OB 30EE1150-4	30	1342	49.22	41.77	21.63	3.0	4.56	3.75	2.79	2.88	1.63	2.28

Bottom Swivel Overhaul Balls available upon request

## Top-Swivel with BK Hook and Non-Swivel Overhaul Balls

For overhaul ball warnings and use limitations see pages 6:45 – 6:46.

Design Factor 4:1



**Top-Swivel  
with BK Hook**

Overhaul Ball Assembly



**Non-Swivel  
Overhaul Balls**

### With BK-13-10 Hook

Model Number	Working Load Limit (short tons)	Weight (lb.)
OBK4EE35-4	4	61
OBK4EE85-4	4	101
OBK4EE150-4	4	169
OBK4EE200-4	4	208

### With BK-16-10 Hook

OBK7EE35-4	7	65
OBK7EE85-4	7	104
OBK7EE150-4	7	172
OBK7EE200-4	7	212

### With BK-18/22-10 Hook

OBK12EE85-4	12	141
OBK12EE150-4	12	210
OBK12EE200-4	12	250
OBK12EE285-4	12	360
OBK12EE350-4	12	404
OBK12EE650-4	12	727
OBK12EE1150-4	12	1172

Model Number	Working Load Limit (short tons)	Weight (lb.)
OB4NS35-2	4	65
OB4NS85-2	4	117
OB4NS150-2	4	185
OB4NS200-2	4	235
OB7NS35-2	7	69
OB7NS85-2	7	121
OB7NS150-2	7	189
OB7NS200-2	7	239
OB12NS85-2	12	145
OB12NS150-2	12	215
OB12NS200-2	12	265
OB12NS285-2	12	348
OB12NS350-2	12	419
OB12NS650-2	12	709
OB12NS1150-2	12	1220
OB19NS85-2	19	179
OB19NS150-2	19	249
OB19NS200-2	19	299
OB19NS350-2	19	451
OB19NS650-2	19	742
OB19NS1150-2	19	1250
OB25NS350-2	25	480
OB25NS650-2	25	775
OB25NS1150-2	25	1264
OB30NS650-2	30	811
OB30NS1150-2	30	1435



## Swivels

Our Johnson thrust bearing swivels are widely used for the primary purpose of allowing the natural twist in wire rope to rotate as necessary without affecting the suspended load. Standard swivels are available in six different end fitting combinations, from 3 to 30 metric tonnes WLL.

Simple and compact, the swivels are engineered for long life and economical cost. Hooks are forged alloy steel, lubrication fittings are recessed, and a generous bronze bushing assures toughness and long life.



### Standard Equipment

- Forged hook with latch
- Roller thrust bearing
- Large bronze thrust bushing
- Recessed lubrication fitting
- Large lubricant reservoir
- Proof load test

### Optional Equipment

- Custom end fitting sizes
- Custom sizes above 30 metric tonnes WLL
- Anti-corrosion coatings
- CE compliant upon request.

## The Simple and Compact Design of a Johnson Swivel

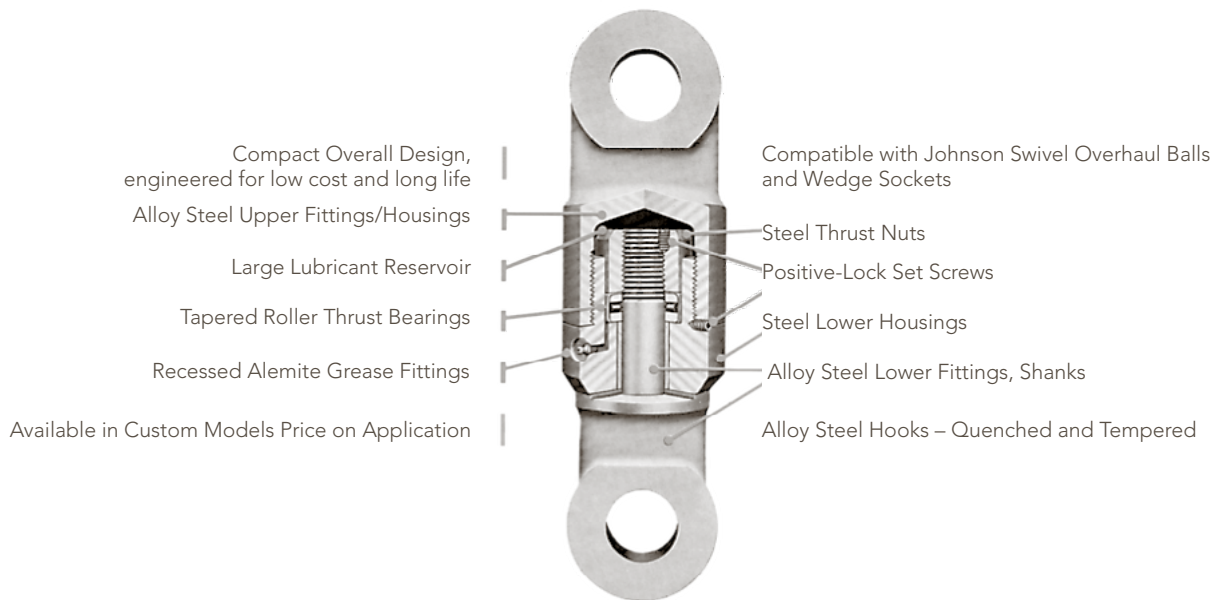

## Swivel Eye/Hook, 3 - 30 metric tonnes

Design Factor - see table

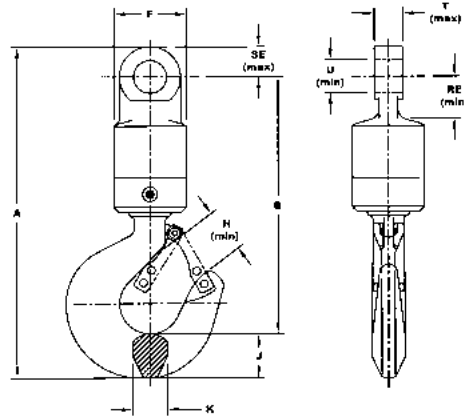

Key to Eye/Hook Swivel Model Numbers:

- 3 - Working Load Limit (metric tonnes)
- E - Top Fitting (E = Eye)
- H - Bottom Fitting (H = Hook)
- M - Midget Swivel

To order please specify the model number.

Art.no.	Model No.	WLL metric tonnes	A Overall Length	B Net Length	F Swivel Dia.	H Throat Opening with Latch	J Hook Thickness	K Hook Width	RE Hole to Obstruction Min	SE Hole to End of Fitting Max	T Thickness of Eye Max	U Hole Dia. Min	Weight lb	Design Factor
471266	3EHM	3	10.58	7.91	2.63	1.12	1.48	1.12	1.23	1.22	0.91	1.03	8	5
471268	3EH	3	13.46	10.73	3.25	1.12	1.48	1.12	1.56	1.34	1.03	1.31	15	5
471270	5EH	5	13.79	11.06	3.25	1.12	1.48	1.12	1.55	1.34	1.03	1.30	15	4
471272	7EH	7	14.82	11.76	3.25	1.39	1.81	1.38	1.55	1.34	1.03	1.31	16	4
471274	9EH	9	18.56	14.03	4.00	1.91	2.53	1.93	2.24	2.03	1.28	1.78	34	4
471276	12EH	12	18.89	14.36	4.44	1.91	2.53	1.93	2.43	2.03	1.28	1.78	39	4
471278	15EH	15	18.89	14.36	4.44	1.91	2.53	1.93	2.43	2.03	1.28	1.78	39	4
471280	20EH	20	22.83	17.45	5.25	2.80	3.00	2.38	2.78	2.50	1.66	2.10	69	4
471281	25EH	25	24.78	18.90	5.25	3.28	3.50	3.00	2.78	2.50	1.66	2.10	90	5
471282	30EH	30	26.53	20.28	6.50	3.28	3.50	3.00	2.79	2.88	1.63	2.32	117	4

## Swivel Jaw/Hook, 3 - 15 metric tonnes

Design Factor - see table

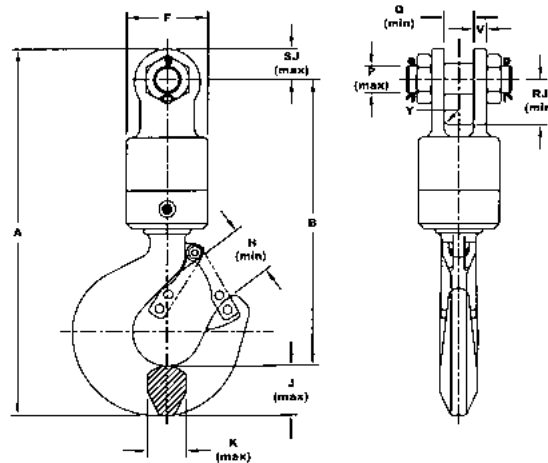

Key to Jaw/Hook Swivel Model Numbers:

- 3 - Working Load Limit (metric tonnes)
- J - Top Fitting (J = Jaw)
- H - Bottom Fitting (H = Hook)
- M - Midget Swivel

To order please specify the model number.

Art.no.	Model No.	WLL metric tonnes	A Overall Length	B Net Length	F Swivel Dia.	H Throat Opening with Latch	J Hook Thickness	K Hook Width	P Pin Dia. Max	Q Width Between Ears Min	RJ Pin to Obstruction Min	SJ Pin to End of Fitting Max	V Thickness of Ear	Y Jaw Radius	Weight lb	Design Factor
471267	3JHM	3	10.52	7.91	2.63	1.12	1.48	1.12	1.00	0.97	1.08	1.22	0.50	0.09	8.60	5
471269	3JH	3	13.71	10.85	3.25	1.12	1.48	1.12	1.25	1.44	2.07	1.43	0.56	0.25	18.08	5
471271	5JH	5	14.04	11.18	3.25	1.12	1.48	1.12	1.25	1.44	2.07	1.43	0.56	0.25	18.96	4
471273	7JH	7	15.07	11.89	3.25	1.39	1.81	1.38	1.25	1.44	2.07	1.43	0.56	0.25	19.84	4
471275	9JH	9	18.62	14.09	4.00	1.91	2.53	1.93	1.75	1.69	2.69	2.06	0.75	0.25	39.90	5
471277	12JH	12	19.14	14.61	4.44	1.91	2.53	1.93	1.75	1.94	2.94	2.06	0.75	0.25	44.97	4
471279	15JH	15	19.14	14.61	4.44	1.91	2.53	1.93	1.75	1.94	2.94	2.06	0.75	0.25	44.97	4

## Swivel Eye/Eye, 3 - 30 metric tonnes

Design Factor 5:1, CE marked

### Key to Eye/Eye Swivel Model Numbers:

- 3 - Working Load Limit (metric tonnes)
- E - Top Fitting (E = Eye)
- E - Bottom Fitting (E = Eye)
- M - Midget Swivel

To order please specify the model number.

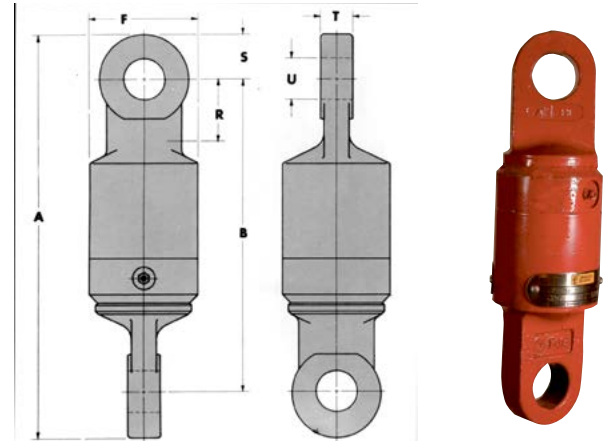

Art.no.	Model No.	WLL metric tonnes	A Overall Length	B Net Length	F Swivel Dia.	R Hole to Obstruction Min	S Hole to End of Fitting Max	T Thickness of Eye Max	U Hole Dia. Min	Weight lb
471430	3EEM	3	8.03	5.65	2.63	1.25	1.25	0.91	1.03	6
471769	4EE	4	12.03	9.47	3.25	1.55	1.34	1.03	1.31	14
471434	7EE	7	11.90	9.34	3.25	1.55	1.34	1.03	1.31	14
471438	12EE	12	15.29	11.29	4.00	2.42	2.03	1.28	1.78	26
471442	19EE	19	15.90	11.90	4.44	2.47	2.03	1.28	1.78	32
471446	25EE	25	17.70	12.95	5.25	2.79	2.41	1.66	2.10	50
471447	30EE	30	20.21	14.71	6.50	2.60	2.78	1.63	2.31	85

## Swivel Jaw/Jaw, 3 - 19 metric tonnes

Design Factor 5:1, CE marked

### Key to Jaw/Jaw Swivel Model Numbers:

- 3 - Working Load Limit (metric tonnes)
- J - Top Fitting (J = Jaw)
- J - Bottom Fitting (J = Jaw)
- M - Midget Swivel.

To order please specify the model number.

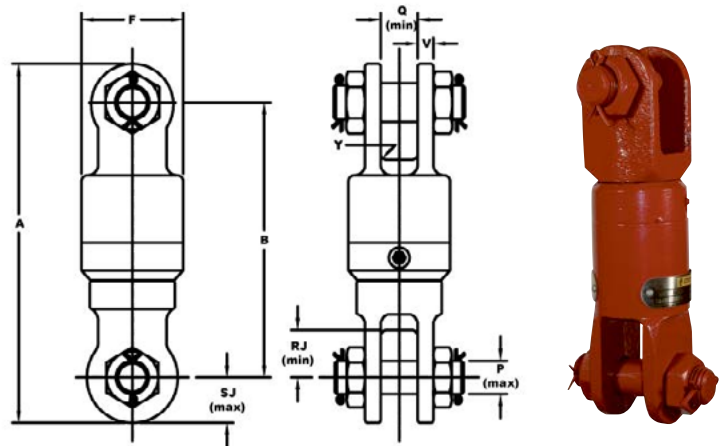

Art.no.	Model No.	WLL metric tonnes	A Overall Length	B Net Length	F Swivel Dia.	P Pin Dia. Max	Q Width Between Ears Min	R Pin to Obstruction Min	S Pin to End of Fitting Max	V Thickness of Ear	Y Jaw Radius	Weight lb
471433	3JJM	3	8.21	5.89	2.63	1.00	0.97	1.32	1.25	0.50	0.09	8
471772	4JJ	4	12.48	9.71	3.25	1.25	1.44	2.07	1.44	0.56	0.25	22
471437	7JJ	7	12.48	9.71	3.25	1.25	1.44	2.07	1.44	0.56	0.25	22
471441	12JJ	12	15.61	11.61	4.00	1.75	1.69	2.69	2.06	0.75	0.25	42
471445	19JJ	19	16.64	12.64	4.44	1.75	1.94	2.94	2.06	0.75	0.25	47

## Swivel Jaw/Eye, 3 - 19 metric tonnes

Design Factor 5:1, CE marked

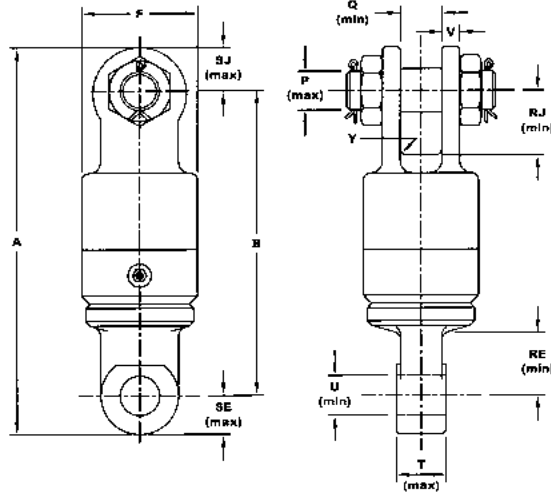

### Key to Jaw/Eye Swivel Model Numbers:

- 3 - Working Load Limit (metric tonnes)
- J - Top Fitting (J = Jaw)
- E - Bottom Fitting (E = Eye)
- M - Midget Swivel

To order please specify the model number.

Art.no.	Model No.	WLL metric tonnes	A Overall Length	B Net Length	F Swivel Dia.	P Pin Dia. Max.	Q Width Between Ears Min.	RE Hole to Obstruction Min.	RJ Pin to Obstruction Min.	SE Hole to End of Fitting Max.	SJ Pin to End of Fitting Max.	T Thickness of Eye Max.	U Hole Dia. of Fitting Min.	V Thickness of Ear	Y Jaw Radius	Weight lb
471432	3JEM	3	7.96	5.65	2.63	1.00	0.94	1.32	1.32	1.25	1.22	0.93	1.03	0.50	0.09	7
471771	4JE	4	12.15	9.45	3.25	1.25	1.44	1.55	2.07	1.40	1.37	0.94	1.31	0.56	0.25	17
471436	7JE	7	12.28	9.50	3.25	1.25	1.44	1.55	2.12	1.37	1.38	1.00	1.25	0.56	0.25	17
471440	12JE	12	15.54	11.54	4.00	1.75	1.72	2.43	2.72	2.03	2.03	1.28	1.78	0.75	0.25	33
471444	19JE	19	15.90	11.90	4.44	1.75	1.97	2.43	2.97	2.03	2.03	1.28	1.78	0.75	0.25	38

## Swivel Eye/Jaw, 3 - 19 metric tonnes

Design Factor 5:1, CE marked

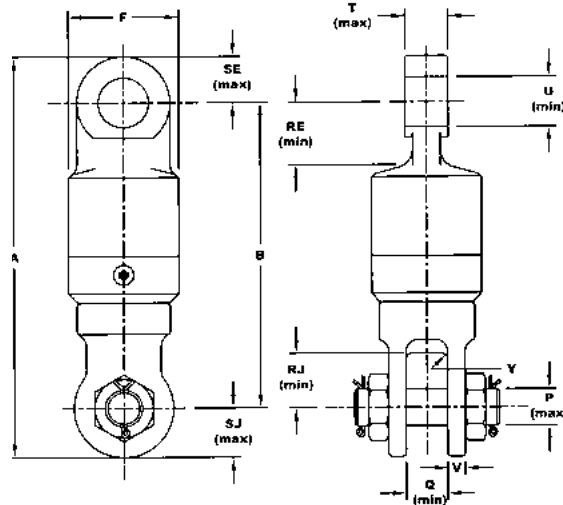

### Key to Eye/Jaw Swivel Model Numbers:

- 3 - Working Load Limit (metric tonnes)
- E - Top Fitting (E = Eye)
- J - Bottom Fitting (J = Jaw)
- M - Midget Swivel

To order please specify the model number.

Art.no.	Model No.	WLL metric tonnes	A Overall Length	B Net Length	F Swivel Dia.	P Pin Dia. Max.	Q Width Between Ears Min.	RE Hole to Obstruction Min.	RJ Pin to Obstruction Min.	SE Hole to End of Fitting Max.	SJ Pin to End of Fitting Max.	T Thickness of Eye Max.	U Hole Dia. Min.	V Thickness of Ear	Y Jaw Radius	Weight lb
471431	3EJM	3	8.27	5.90	2.63	1.00	0.97	1.25	1.35	1.22	1.22	0.91	1.03	0.50	0.09	7.28
471770	4EJ	4	12.23	9.59	3.25	1.25	1.44	1.63	2.07	1.28	1.44	1.03	1.31	0.56	0.25	18.08
471435	7EJ	7	12.23	9.59	3.25	1.25	1.44	1.63	2.07	1.28	1.44	1.03	1.31	0.56	0.25	18.08
471439	12EJ	12	15.61	11.61	4.00	1.75	1.69	2.53	2.69	2.03	2.06	1.28	1.78	0.75	0.25	35.05
471443	19EJ	19	16.39	12.39	4.44	1.75	1.94	2.44	2.94	2.03	2.06	1.28	1.78	0.75	0.25	42.11

## Open Wedge Sockets

Open Wedge Sockets combine positive attachment with optimum versatility. Easy-to-change Johnson Wedge Sockets are a high strength cast alloy steel with charpy value of 25 ft-lb (34J) at -4 F. Each socket accepts at least two different ductile iron wedges. This allows the socket to be used with more than one rope size. Together, wedge and body act as a vise which grips the wire rope and locks it into place.

### Key to Open Wedge Socket Model Numbers:

- WS - Wedge Socket
- FS - Federal Specification
- 6 - Body Number
- 3/4" - Wire Rope Wedge Size

To order please specify the model number.



## Open Wedge Socket 3/8" to 1 1/2"

Design Factor 4:1

Art.no.	Model No.	Wire Rope	Weight lb	A Overall Length	B Net Length	E Total Thickness	P Pin Dia.	Q Width Between Ears Min	R Pin to End of Fitting	S Pin to End of Fitting	V Thickness of Ear
472371	WS-4	3/8"	3.31	6.50	5.38	2.58	1.02	0.94	1.20	1.13	0.44
472372	WS-4	7/16"	3.31	6.50	5.38	2.58	1.02	0.94	1.20	1.13	0.44
472373	WS-4	1/2"	3.31	6.50	5.38	2.58	1.02	0.94	1.20	1.13	0.44
472374	WS-5	1/2"	8.82	8.72	7.25	3.55	1.27	1.38	1.80	1.47	0.65
472375	WS-5	9/16"	8.82	8.72	7.25	3.55	1.27	1.38	2.00	1.47	0.65
472376	WS-5	5/8"	8.82	8.72	7.25	3.55	1.27	1.38	2.00	1.47	0.65
472377	WS-6	5/8"	9.26	8.81	7.31	3.55	1.27	1.50	1.90	1.50	0.62
472378	WS-8A	5/8"	16.09	11.26	9.13	4.18	1.65	1.69	2.60	2.13	0.50
472379	WS-6	3/4"	9.26	8.81	7.31	3.55	1.27	1.50	1.40	1.50	0.62
472380	WS-8A	3/4"	16.09	11.26	9.13	4.18	1.65	1.69	2.40	2.13	0.50
472381	WS-7	7/8"	16.09	11.13	9.50	3.55	1.27	1.31	2.30	1.63	0.69
472382	WS-8	7/8"	18.08	11.38	9.50	4.18	1.65	1.69	2.10	1.88	0.81
472383	WS-7	1"	16.09	11.13	9.50	3.55	1.27	1.31	2.50	1.63	0.69
472384	WS-8	1"	18.08	11.38	9.50	4.18	1.65	1.69	2.20	1.88	0.81
472385	WS-10	1 1/8"	46.08	15.44	13.25	4.18	1.65	1.75	3.10	2.19	0.81
472386	WS-11	1 1/8"	54.01	16.00	13.50	5.19	2.52	2.44	4.40	2.50	0.87
472387	WS-10	1 1/4"	46.08	15.44	13.25	4.18	1.65	1.75	3.10	2.19	0.81
472388	WS-11	1 1/4"	54.01	16.00	13.50	5.19	2.52	2.44	4.30	2.50	0.87
474271	FS-26	1 3/8"	95.02	18.38	15.00	6.36	3.02	2.63	4.20	3.38	1.31
472389	FS-26	1 1/2"	95.02	18.38	15.00	6.36	3.02	2.63	4.20	3.38	1.31

Provides a termination efficiency 80%, based on the catalog minimum breaking force of 6x19, 6x25, and 6x36, IWRC wire rope.

6



## Snatch Blocks

Johnson Snatch Blocks have the convenient side opening feature. This is true even of our heavy duty top dead-end models, and makes it easy to reeve the block without removing any fitting from the end of the wire rope. Other features include choice of swivel hook, shackle, eye fittings or Tailboard Blocks which have no fittings at all.

### Standard Features

- Rugged and reliable
- 4:1 design factor
- Easy-open side plates
- Metric rated
- Large hand nuts
- Retainer on latch pin
- Bow shackle with retainer pin
- Bronze bushing

### Optional Features

- Proof load
- Roller bearings
- Marine epoxy paint
- Heavy duty J-latch
- Larger sizes
- Customized blocks
- CE compliant upon request

### Wide Range

We offer over 250 models and sizes, from 2 to 30 metric tonnes. Sheave sizes from 3 to 24 inches in diameter. Multiple rope sizes and end fittings available.

### Rugged

Johnson's famous durability is well established in the industry. These blocks stand up to the toughest applications, whether in blistering sun or under icy blizzard conditions.

### Reliable

From built-in strength comes the reliability long associated with the Johnson name. These blocks are performers, day after day and year after year.

### Many Choices

Singles, doubles, top dead end, towing, oilfield, pipe laying and general construction. Sizes and specific models for all.

### Convenient

Large, easy to grip hand nuts on all models, especially on the smallest models. Makes it easier to open and close under all conditions without removing gloves, and easy to tap with a hammer to loosen or lock down.

### Secondary Securement

All hand nuts and shackles are fitted with "R" pins as a secondary securement device, for example where inspection is limited or infrequent due to location or other factors.

## Snatch Block - Tailboard

### Single Sheave

Design Factor 4:1, CE marked



Art.no.	Model	WLL metric tonnes	Sheave diameter	Wire Rope Size	Weight lb
474572012QR3	SB2S3BT	2	3"	5/16" - 3/8" (8-10 mm)	3
474562016QR3	SB4S4BT	4	4"	3/8" - 1/2" (10-13 mm)	10
474621016QR3	SB4S6BT	4	6"	3/8" - 1/2" (10-13 mm)	13
474624016QR3	SB4S8BT	4	8"	3/8" - 1/2" (10-13 mm)	17
474542024QR3	SB8S6BT	8	6"	5/8" - 3/4" (16-19 mm)	16
474369024QR3	SB8S8BT	8	8"	5/8" - 3/4" (16-19 mm)	25
474375024QR3	SB8S10BT	8	10"	5/8" - 3/4" (16-19 mm)	31
474381024QR3	SB8S12BT	8	12"	5/8" - 3/4" (16-19 mm)	34
474410028QR3	SB12S6BT	12	6"	3/4" - 7/8" (20-22 mm)	28
474416028QR3	SB12S8BT	12	8"	3/4" - 7/8" (20-22 mm)	42
474422028QR3	SB12S10BT	12	10"	3/4" - 7/8" (20-22 mm)	54
474733036QR3	SB20S8BT	20	8"	1" - 1 1/8" (26-29 mm)	46
474734036QR3	SB20S10BT	20	10"	1" - 1 1/8" (26-29 mm)	65
474742040QR3	SB30S20BT	30	20"	1 1/8" - 1 1/4" (29-32 mm)	205

## Snatch Block with Shackle

### Single Sheave

Design Factor 4:1, CE marked

Art.no.	Model	WLL metric tonnes	Sheave diameter	Wire Rope Size	Weight lb
474602012QR3	SB2S3BS	2	3"	5/16" - 3/8" (8-10 mm)	5
474603016QR3	SB4S4BS	4	4"	3/8" - 1/2" (10-13 mm)	17
474620016QR3	SB4S6BS	4	6"	3/8" - 1/2" (10-13 mm)	20
474623016QR3	SB4S8BS	4	8"	3/8" - 1/2" (10-13 mm)	24
474644016QR3	SB4S10BS	4	10"	3/8" - 1/2" (10-13 mm)	33
474365024QR3	SB8S6BS	8	6"	5/8" - 3/4" (16-19 mm)	28
474371024QR3	SB8S8BS	8	8"	5/8" - 3/4" (16-19 mm)	37
474377024QR3	SB8S10BS	8	10"	5/8" - 3/4" (16-19 mm)	43
474587024QR3	SB8S12BS	8	12"	5/8" - 3/4" (16-19 mm)	54
474412028QR3	SB12S6BS	12	6"	3/4" - 7/8" (20-22 mm)	50
474418028QR3	SB12S8BS	12	8"	3/4" - 7/8" (20-22 mm)	64
474424028QR3	SB12S10BS	12	10"	3/4" - 7/8" (20-22 mm)	76
474582028QR3	SB12S12BS	12	12"	3/4" - 7/8" (20-22 mm)	92
474436028QR3	SB12S14BS	12	14"	3/4" - 7/8" (20-22 mm)	110
474455028QR3	SB15S8BS	15	8"	3/4" - 7/8" (20-22 mm)	64
474461028QR3	SB15S10BS	15	10"	3/4" - 7/8" (20-22 mm)	78
474647036QR3	SB20S8BS	20	8"	1" - 1 1/8" (26-29 mm)	95
474728036QR3	SB20S10BS	20	10"	1" - 1 1/8" (26-29 mm)	114
474729036QR3	SB20S12BS	20	12"	1" - 1 1/8" (26-29 mm)	117
474730036QR3	SB20S14BS	20	14"	1" - 1 1/8" (26-29 mm)	128
474731036QR3	SB20S16BS	20	16"	1" - 1 1/8" (26-29 mm)	161
474740040QR3	SB30S20BS	30	20"	1 1/8" - 1 1/4" (29-32 mm)	298



## Snatch Block with Hook and Latch

### Single Sheave

Design Factor 4:1, CE marked

Art.no.	Model	WLL metric tonnes	Sheave diameter	Wire Rope Size	Weight lb
475092012QR3	SB2S3BH	2	3"	5/16" - 3/8" (8-10 mm)	5
474655016QR3	SB4S4BH	4	4"	3/8" - 1/2" (10-13 mm)	16
475090016QR3	SB4S6BH	4	6"	3/8" - 1/2" (10-13 mm)	19
475093016QR3	SB4S8BH	4	8"	3/8" - 1/2" (10-13 mm)	22
474601024QR3	SB8S8BH	8	8"	5/8" - 3/4" (16-19 mm)	35
475104024QR3	SB8S10BH	8	10"	5/8" - 3/4" (16-19 mm)	42
474583024QR3	SB8S12BH	8	12"	5/8" - 3/4" (16-19 mm)	53
475109028QR3	SB12S6BH	12	6"	3/4" - 7/8" (20-22 mm)	46
474577028QR3	SB12S8BH	12	8"	3/4" - 7/8" (20-22 mm)	60
474594028QR3	SB12S10BH	12	10"	3/4" - 7/8" (20-22 mm)	72
474581028QR3	SB12S12BH	12	12"	3/4" - 7/8" (20-22 mm)	88
475119028QR3	SB15S8BH	15	8"	3/4" - 7/8" (20-22 mm)	66
475121028QR3	SB15S10BH	15	10"	3/4" - 7/8" (20-22 mm)	80
475123028QR3	SB15S12BH	15	12"	3/4" - 7/8" (20-22 mm)	97
475129036QR3	SB20S8BH	20	8"	1" - 1 1/8" (26-29 mm)	81
475131036QR3	SB20S10BH	20	10"	1" - 1 1/8" (26-29 mm)	100
475133036QR3	SB20S12BH	20	12"	1" - 1 1/8" (26-29 mm)	103
474823040QR3	SB30S20BH	30	20"	1 1/8" - 1 1/4" (26-29 mm)	276
475142040QR3	SB30S24BH	30	24"	1 1/8" - 1 1/4" (29-32 mm)	342



6

## Top Deadend Snatch Block with Shackle and Latch Single Sheave

Design Factor 4:1



Art.no.	Model	WLL metric tonnes	Sheave diameter	Wire Rope Size	Weight lb
474748016	TD4S6BS	4	6"	3/8" - 1/2" (10-13 mm)	22.93
474756024	TD8S8BS	8	8"	5/8" - 3/4" (16-19 mm)	39.9
474755024	TD8S6BS	8	6"	5/8" - 3/4" (16-19 mm)	35.05
474757024	TD8S10BS	8	10"	5/8" - 3/4" (16-19 mm)	46.96
474758024	TD8S12BS	8	12"	5/8" - 3/4" (16-19 mm)	59.08
474767028	TD12S10BS	12	10"	3/4" - 7/8" (20-22 mm)	78.93
474769028	TD12S14BS	12	14"	3/4" - 7/8" (20-22 mm)	111.99
475205028	TD15S10BS	15	10"	3/4" - 7/8" (20-22 mm)	76.94
475210028	TD15S12BS	15	12"	3/4" - 7/8" (20-22 mm)	95.9
474771036	TD20S14BS	20	14"	1" - 1 1/8" (26-29 mm)	145.95



## Top Deadend Snatch Block with Shackle Double Sheave

Design Factor 4:1

Art.no.	Model	WLL metric tonnes	Sheave diameter	Wire Rope Size	Weight lb
474774016	DB8D4BS	8	4"	3/8" - 1/2" (10-13 mm)	29.98
474781024	DB12D6BS	12	6"	5/8" - 3/4" (16-19 mm)	54.01
474792028	DB15D8BS	15	8"	3/4" - 7/8" (20-22 mm)	70.99
474801036	DB20D10BS	20	10"	1" - 1 1/8" (26-29 mm)	143.96



## Top Deadend Snatch Block with Hook and Latch Single Sheave

Design Factor 4:1

Art.no.	Model	WLL metric tonnes	Sheave diameter	Wire Rope Size	Weight lb
475253024	TD8S6BH	8	6"	5/8" - 3/4" (16-19 mm)	29.98
475257024	TD8S10BH	8	10"	5/8" - 3/4" (16-19 mm)	44.97
475249024	TD8S12BH	8	12"	5/8" - 3/4" (16-19 mm)	57
475261028	TD12S10BH	12	10"	3/4" - 7/8" (20-22 mm)	74.96
475263028	TD12S14BH	12	14"	3/4" - 7/8" (20-22 mm)	132.06
475270028	TD15S10BH	15	10"	3/4" - 7/8" (20-22 mm)	79
4752271028	TD15S12BH	15	12"	3/4" - 7/8" (20-22 mm)	98
475485036	TD20S14BH	20	14"	1" - 1 1/8" (26-29 mm)	132



## Top Deadend Snatch Block with Hook and Latch Double Sheave

Design Factor 4:1

Art.no.	Model	WLL metric tonnes	Sheave diameter	Wire Rope Size	Weight lb
475285016	DB8D6BH	8	6"	3/8" - 1/2" (10-13 mm)	37.04
475301024	DB12D10BH	12	10"	5/8" - 3/4" (16-19 mm)	78.04
475321028	DB15D10BH	15	10"	3/4" - 7/8" (20-22 mm)	84.00
475323028	DB15D12BH	15	12"	3/4" - 7/8" (20-22 mm)	106.92
475342036	DB20D14BH	20	14"	1" - 1 1/8" (26-29 mm)	184.97



## Tilt Wall Blocks – Shackle Models

Model Number	Working Load Limit (metric tonnes)	Wire Rope Size	Sheave O.D.	Wt.
<b>30 MT</b>				
TW30S16TS	30	1" (26 mm)	16"	235
TW30S16TS	30	1-1/8" (29 mm)	16"	235
TW30S16TS	30	1-1/4" (32 mm)	16"	235
TW30S16TS	30	1-3/8" (35 mm)	16"	235
TW30S16TS	30	1-1/2" (38 mm)	16"	235
TW30S20TS	30	1" (26 mm)	20"	250
TW30S20TS	30	1-1/8" (29 mm)	20"	250
TW30S20TS	30	1-1/4" (32 mm)	20"	250
TW30S20TS	30	1-3/8" (35 mm)	20"	250
TW30S20TS	30	1-1/2" (38 mm)	20"	250
<b>40 MT</b>				
TW40S18TS	40	1" (26 mm)	18"	330
TW40S18TS	40	1-1/8" (29 mm)	18"	330
TW40S18TS	40	1-1/4" (32 mm)	18"	330
TW40S18TS	40	1-3/8" (35 mm)	18"	330
TW40S18TS	40	1-1/2" (38 mm)	18"	330
TW40S24TS	40	1" (26 mm)	24"	420
TW40S24TS	40	1-1/8" (29 mm)	24"	420
TW40S24TS	40	1-1/4" (32 mm)	24"	420
TW40S24TS	40	1-3/8" (35 mm)	24"	420
TW40S24TS	40	1-1/2" (38 mm)"	24"	420
TW40S24TS	40	1-5/8" (41 mm)	24"	420
TW40S24TS	40	1-3/4" (44 mm)	24"	420
TW40S24TS	40	1-7/8" (48 mm)	24"	420
TW40S24TS	40	2" (51 mm)	24"	420
<b>55 MT</b>				
TW55S20TS	55	1" (26 mm)	20"	390
TW55S20TS	55	1-1/8" (29 mm)	20"	390
TW55S20TS	55	1-1/4" (32 mm)	20"	390
TW55S20TS	55	1-3/8" (35 mm)	20"	390
TW55S20TS	55	1-1/2" (38 mm)	20"	390
TW55S24TS	55	1" (26 mm)	24"	450
TW55S24TS	55	1-1/8" (29 mm)	24"	450
TW55S24TS	55	1-1/4" (32 mm)	24"	450
TW55S24TS	55	1-3/8" (35 mm)	24"	450
TW55S24TS	55	1-1/2" (38 mm)"	24"	450
TW55S24TS	55	1-5/8" (41 mm)	24"	450
TW55S24TS	55	1-3/4" (44 mm)	24"	450
TW55S24TS	55	1-7/8" (48 mm)	24"	450
TW55S24TS	55	2" (51 mm)	24"	450
TW55S24TS	55	2-1/4" (57 mm)	24"	450



Tailboard models available upon request

## Oilfield Tubing Blocks



Art.no.	Model No.	WLL (short tons)	Sheave diameter	Number of Sheaves	*Wire rope Size	Rod Hook Clevis Working Load Limit (short tons)	Weight (lb)	Weight (Kg)
475667028QR1	TB 75T 20TTA	75	20"	3	7/8" (22 mm)	25	1 685	764
475688028QR1	TB 75T 20TTB	75	20"	3	7/8" (22 mm)	25	2 140	971
475671032QR1	TB 100T 24TTA	100	24"	3	1" (26 mm)	35	2 252	1 022
475689032QR1	TB 100T 24TTB	100	24"	3	1" (26 mm)	35	2 950	1 338
475672032QR1	TB 100Q 24TTA	100	24"	4	1" (26 mm)	35	2 815	1 277
475690032QR1	TB 100Q 24TTB	100	24"	4	1" (26 mm)	35	3 514	1 594
475731032QR1	TB 125T 24TTA	125	24"	3	1" (26 mm)	35	2 252	1 022
475732032QR1	TB 125T 24TTB	125	24"	3	1" (26 mm)	35	2 950	1 338
475729032QR1	TB 125Q 24TTA	125	24"	4	1" (26 mm)	35	2 815	1 277
475730032QR1	TB 125Q 24TTB	125	24"	4	1" (26 mm)	35	3 514	1 594
475674036QR1	TB 150T 30TTA	150	30"	3	1 1/8" (29 mm)	35	3 560	1 615
475691036QR1	TB 150T 30TTB	150	30"	3	1 1/8" (29 mm)	35	4 702	2 133
475675036QR1	TB 150Q 30TTA	150	30"	4	1 1/8" (29 mm)	35	3 965	1 799
475692036QR1	TB 150Q 30TTB	150	30"	4	1 1/8" (29 mm)	35	5 106	2 316
475757036QR1	TB175T 30TTA	175	30"	3	1 1/8" (29 mm)	35	3 560	1 615
475758036QR1	TB175T 30TTB	175	30"	3	1 1/8" (29 mm)	35	4 702	2 133
475759036QR1	TB175Q 30TTA	175	30"	4	1 1/8" (29 mm)	35	3 965	1 799
475760036QR1	TB175Q 30TTB	175	30"	4	1 1/8" (29 mm)	35	5 106	2 316

\* Note: Additional Wire Rope Sizes Upon Request

- API 8C PSL1 compliant
- Concurrent hardening™ on sheave grooves
- Equipped with tapered roller bearings
- Optional cheek weight kits available
- Non-spring loaded duplex hook
- Hook positioning locking device, 8 positions
- Includes rod hook clevis as standard
- Hook latches with self-retaining bolt

## Tubing Block Rod Hook Clevis



Art.no.	WLL (short tons)	Weight (lb)	Weight (Kg)	Tubing Block Capacity (short tons)
475695	25	46	21	75
475696	35	71	32	100
475696	35	71	32	125
475697	35	111	50	150

- High capacity rating
- Life cycle tested
- API 8C PSL1 compliant

## Manhandler Snatch Block

Design Factor 12:1, CE marked

Johnson's Manhandler Snatch Blocks (MHSB) are suitable for personnel hoisting when properly incorporated into a compliant personnel hoist system and maintained in good working order.

See the Manhandler Warnings and Use Limitations Brochure available from Gunnebo Industries and your distributor.

- Standard painted finish
- For lifting personnel
- Sealed roller bearings
- Interlocking internal design
- R-pins retainers
- Secondary tether attachment points



Art. no	Model	WLL lb	Wire rope	Sheave diameter	Weight lb
687431014	MHSB1S8RS	1 500	3/8"-1/2" (10 - 13mm)	7.87	23

## Galvanized Derrick Block

Design Factor 4:1

- 4 - 20 metric tonnes WLL
- Standard galvanized finish
- Handling slots in the body
- Large knock-off handles
- Interlocking internal design
- For lifting materials
- R-Pin retainers

Art. no	Model	WLL metric tonnes	Wire rope	Sheave diameter	Weight lb
687710016	MHSB4S8TS	4	3/8"-1/2" (10 - 13mm)	8	33.07
687334018	MHSB12S10TS	12	1/2"-9/16" / 13 - 14mm)	10	87.96
687853024	MHSB12S14TS	12	5/8"-3/4" (16 -19mm)	14	127.87
693030028	MHSB20S14TS	20	3/4" - 7/8" (19 - 22 mm)	14	179.02



## Oilfield Blocks

We have produced Johnson oilfield equipment for over five decades. Because of our expertise in sheaves and blocks, Gunnebo Industries has become a respected manufacturer for the Petroleum industry. We know the needs and we have the know-how to fulfil them with quality lifting devices. High capacity, custom engineered oilfield blocks available upon request.



Laydown Block

Tong Line Block

Hayfork Pulley

Guy Line Block

## Laydown Block, 1 metric tonnes

Design Factor 4:1

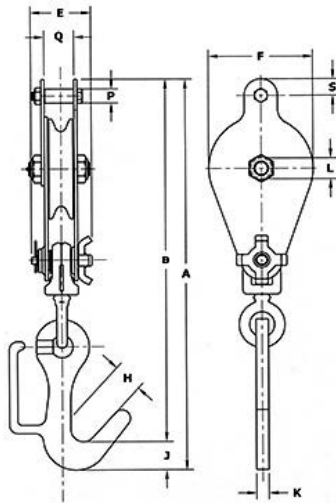

Key to Laydown Block Model Numbers:

- LD – Laydown Block
- 1 – Working Load Limit
- S – Number of sheaves: S = 1
- 6 – Sheave diameter (In inches)
- B – Sheave Bearing: B = Bronze Bushed
- H – Type of fitting: H = Hook

To order please specify the model number

Art.no.	Model No.	Weight lb	A Overall Length	B Net Length	E Total Thickness	F Width	H Throat Opening	J Hook Thickness	K Hook Width	L Center Pin Dia.	P Pin Dia. Max	Q Width Between Ears Min	S Pin to End of Fitting Max
474812020	LD1S6BH	20.94	23.57	21.85	3.63	6.26	3.00	1.72	0.75	25.4	21.3	44.7	26.9

## Tong Line Block

Design Factor 4:1

Art.no.	Model	WLL metric tonnes	Sheave diameter	Wire Rope Size	Weight lb
474805020	TL2.8S6RE	2.8	6"	Suits 1/2"-5/8" (13 - 16 mm) wire rope	14.99
474807020	TL2.8S8RE	2.8	8"	Suits 1/2"-5/8" (13 - 16 mm) wire rope	20.06



## Hay Fork Pulley, 1 short tons

Design Factor 3.3:1

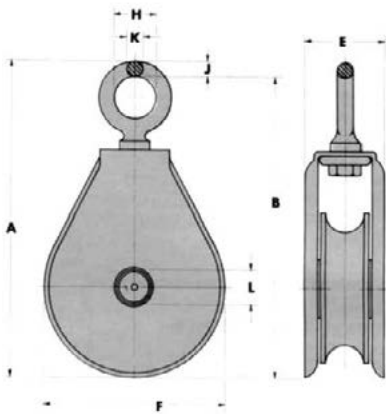

Key to Hay Fork Pulley Model Numbers:

- HF - Hay Fork Pulley
- 1 - Working Load Limit (U.S. Tons)
- S - Number of sheaves: S = 1
- 4 - Sheave Diameter
- B - Sheave bearing: B = Bronze Bushed | R = Roller Bearing
- E - Type of Fitting: E = Eye | H = Hook
- MR - Rope Size: MR = 32mm Manilla Rope | WR = 13 mm Wire Rope

To order please specify the model number



Art.no.	Model No.	Manilla/Wire Rope	A Overall Length	B Net Length	E Total Thickness	F Width	H Throat Opening	J Eye Thickness	K Eye Width	L Center Pin Dia.	Weight lb
453865040	HF1S4BE-MR	1-1/4"	9.00	8.56	2.37	5.13	0.87	0.44	0.44	1.00	7.05
453866016	HF1S4BE-WR	1-1/4"	9.00	8.56	2.37	5.13	0.87	0.44	0.44	1.00	7.05
453869040	HF1S4RE-MR	1/2"	9.00	8.56	2.37	5.13	0.87	0.44	0.44	1.00	7.05
453870016	HF1S4RE-WR	1/2"	9.00	8.56	2.37	5.13	0.87	0.44	0.44	1.00	7.05

6

## Guyline Block

Design Factor 3:1

Art.no.	Model	WLL metric tonnes	Sheave diameter	Wire Rope Size	Weight lb
475541020	GL 15D6	15	6"	Suits 5/8" (16 mm) wire rope	42.11
475540020	GL 7.5S 6	7.5	6"	Suits 5/8" (16 mm) wire rope	24.91



## J-Latch Replacement Kit



Johnson's exclusive J-Latch is a uniquely engineered hook latch system providing outstanding flexibility and durability. Its heavy-duty design incorporates a steel beam that positively engages a special recessed area in the hook tip. The removable two-position pin allows the J-Latch to function either as a locked bar or as an automatic spring latch.

The J-Latch meets OSHA requirements and is standard equipment on Johnson crane blocks through 330 short tons, all Johnson overhaul balls, and all swivels and snatch blocks with hooks.



Art.no.	J-Latch Kit no.	Crane Block WLL (short tons)	Weight (lb)	Weight (Kg)	Hook Part Numbers
471782	JL3-5	3-5	0.2	0.09	2590 / 10390 / 10153
471784	JL10-15	10-15	0.4	0.18	2217 / 10392
471786	JL30	30	1.5	0.68	2635
471787	JL35-45	35-45	2.1	0.95	2633
471788	JL50-70	50-70	5.0	2.3	2636 / 2637
471789	JL75-110	75-110	7.3	3.3	2638 / 2639
471790	JL115-175	115-175	8.5	3.9	2600 / 2630
474206	JL200-300	200-330	35	15.9	1096 / 4012 / 11363

Note: J-Latches fit only Johnson hooks with a lock pin hole drilled through hook tip.





6

\*Safety factor 4:1

All dimensions in inches

# General Precautions

**Stay within the Working Load Limits of all Gunnebo Industries products.** The Working Load Limits assigned Gunnebo Industries products reflect our best engineering assessment. They should never be exceeded, regardless of the strength of the wire rope being used. Nor will we accept responsibility for any rating request which would result in a lower design factor than that we judge to be adequate. (See design factors indicated in this catalog. Standard: 4 to 1.)

Note that Working Load Limits apply only to loads held uniformly in direct tension. They do not apply to shock loads, which can multiply the static weight factor many times over. Likewise, they do not allow for hook tip loading, side loading, or for bending, torsional and related loads.

Note also that Working Load Limits apply only to new products as they are shipped from the factory. Age, type of service and environmental conditions can subsequently affect these limits, and periodic tests should be undertaken to assure the product will perform in accord with existing regulations and sound operating practices.

**Do not misuse Gunnebo Industries Blocks hook latch attachments.** Gunnebo Industries Blocks hook latch kits are designed solely for loose sling retention. They are not anti-fouling devices, and caution must be exercised to prevent a latch from supporting any portion of the load. Protect the latch, and thereby the workmen below, by: 1) continuous inspection to see that the latch is undamaged, in place, and properly centered on the hook; 2) taking care not to "crowd" the latch with over-sized ropes or "stiff" riggings; making sure the load is properly seated prior to each lift.

**Use caution in applying standard Gunnebo Industries products to severe vibration or sharp-blow situations.** Activities such as pile driving can have adverse effects upon the life of the product and, therefore, may not be covered by the warranty. Standard cheek weights and overhaul balls, for example, are not designed as load-bearing members. They can break under extreme vibration or sharp blows.

Severe working conditions can also create problems for the undersized swivel or standard block. If you anticipate such conditions, have the factory fabricate the block to your particular job requirements. Or, in the case of an existing block, take the following precautions.

- 1) Make sure the block's capacity rating is high enough. If the block has a hook and latch, consider replacing them with the swivel tee and safety anchor shackle that is available as an option on all "J" Blocks.
- 2) Remove any cast iron cheek weights and replace the existing tie bolts with shorter ones. If additional weight is required, have Gunnebo Industries supply steel plate cheek weights to your specifications.
- 3) Tack weld and all tie bolt nuts, trunnion nuts and lower fitting shank nuts to the ends of their respective shafts. Weld the center pin nut, if any, to the side plates of the block itself.

**Never use the yielding point of a hook, bail or other fitting as a "gauge" of its capacity.** Trusting a fitting to bend before it breaks is a dangerous practice and should never be used as an excuse to exceed the Working Load Limit.

**Lift only those loads for which our product was designed.** Federal crane regulations prohibit the transport of personnel on any load or wire rope attachment (OSHA 1910. 180-h-3-v).

**Never "two-block," or allow any block, ball, or other attachment to be drawn into another under power.**

**Inspect your equipment regularly for excessive wear.** Wear is a fact of life, and it will eventually affect load fitting cross sections and other critical component dimensions. Since worn components do not have the same WLL rating, the responsibility for their maintenance and continued use is entirely up to the purchaser/user. To be certain, arrange with federal and local regulations. For general maintenance instructions, see page 14-16, this catalog.

**When using wedge sockets note that two precautions should be taken.**

1. Make sure that a sudden jolt or impact does not dislodge a wedge. When installing wire rope, always pre-load the wedge with wire rope in place. Check frequently to re-tighten or reposition as necessary.
2. Make allowance for the crimping effect common with all types of wedge sockets. Experience shows it will reduce the Safe Working Limit of a line by 20 percent.



# General Precautions

**Never weld any load bearing components such as hooks, shackles or other load fittings. Any welding to a load fitting could adversely affect the strength capabilities of the material.**

**Do not immerse standard Gunnebo Industries products in water.** Contact our Engineering Department for those special product designs necessary to meet fresh and salt water applications.

**Make sure your wire rope is sufficiently rated for its overhaul ball and socket assembly attachments.** Gunnebo Industries offers a variety of wedge socket overhaul balls. As with other products, some of these balls have strengths substantially greater than the ropes to which they have been applied. To be sure, consult the chart "Working Load Limits of Wire Rope." Type, application and WLL are the sole responsibility of the customer and the end user.

See website or user instructions for assembly instructions.

Meets listed current specifications and standards at time of publication of this catalogue.

Attention to the service temperature (ST) given on the WLL nameplate is required. Gunnebo Industries blocks have a temperature at which lifting precautions are required because temperatures below the given ST affect the block material properties. Lifting above 75% of the WLL AND BETWEEN THE ST and -40F (-4C), must be done at a slow and steady rate to avoid stress spikes common in normal hoisting dynamics. 75% of the WLL must not be exceeded when lifting in temperatures below -40F unless extreme temperature materials have been used in the block construction. Blocks are available with extreme temperature materials on special request.

**Do not overload individual sheave bearings by subjecting a partially reeved block to full load applications.** Bearing life expectancy is based on the use of all available sheaves under maximum parts of line. For example, in a 30-ton block with three sheaves, each sheave will have a bearing capacity of 10 tons. If only one sheave is used, it is reduced to 10 tons.

Typical WLL nameplate

 <b>JOHNSON BLOCKS</b>		SERIAL NO.	
MODEL			
ASSY. NO.		DESIGN FACTOR	
<b>WLL</b>	<b>TONS</b>	<b>MTONS</b>	
WIRE ROPE	in	mm	
WEIGHT	lb	kg	
SERV TEMP	°F	°C	
GUNNEBO INDUSTRIES TULSA, OK. U.S.A.		PN: 56413	

Important safety information is provided by the two plates affixed to each product.

Typical safety caution plate

<b>WARNING – USE CAUTION                  READ BEFORE USING</b>	
Violation of these instructions will be at sole risk of user. WORKING LOAD LIMIT (W.L.L.) shown on nameplate or catalog SHOULD NEVER BE EXCEEDED. Doing so will permanently void warranty. DESIGN FACTOR is the ratio of ultimate (breaking) strength to W.L.L. Yielding will occur at loads well below ultimate. NEVER EXCEED THE W.L.L. THE OPERATOR SHALL NOT hoist, lower, swing, support or transport personnel on this hook assembly unless complying with applicable federal and local regulations. Doing otherwise is at the sole risk of user. See other safety and maintenance instructions in JOHNSON BLOCKS catalog.	
Do not paint over or remove this plate or nameplate. Gunnebo Industries Corp. Tulsa, Oklahoma	

# Inspection and Maintenance

## Company policy Regarding Product Repair and Parts Replacement

1. Any claim arising from the use of Gunnebo Industries products is subject to the strict performance of the inspection and maintenance activities outlined in the following schedules. Maintenance instructions are shipped by the factory with each product or invoice line item and are available in quantity at no extra charge.
2. Should any Gunnebo Industries product become worn or deficient, any attempt at unauthorized field repairs will be taken entirely at the user's own risk and cost. A better approach is to call the Tulsa plant in advance to discuss the specifics. Then, to return the item in question, the freight prepaid, for a repairs cost estimate.
3. Gunnebo Industries name plates and caution plates must remain in place and visible at all times. In the event either of these plates is lost or rendered illegible, arrangements for their replacement are to be made promptly with the factory.

### ✓ Nut/Retainer Checklist

All nuts, set screws, and other retainers should be checked for tightness every 14 to 30 days, depending on the operating conditions. Review general precautions relating to high vibration application.

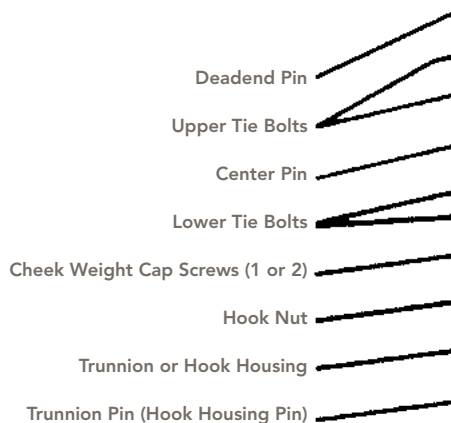

### ✓ Center Pin Retaining Nuts

Check regularly for any signs of backing off due to high vibration or other causes. If the block has tapered roller bearings (as indicated by T on name plate), tighten the center pin retaining nut(s) until all side play has been eliminated from the sheaves and re-set the lock type set screws.

For other sheave bearing types (bronze bushing – B: roller bearing – R), a running clearance of 1/32 inches at the sheave hub is required. Since to ignore this clearance is to risk sheave bearing damage, it may be approximated as follows:

- (1) Slowly tighten the retaining nut(s), testing the roller capability of the sheaves with your hand as you do so.
- (2) When there is any one of the sheaves that can no longer be turned in this fashion, stop. Back off the nut(s) just enough so that all sheaves will rotate freely. Then re-stake or tighten all set screws as applicable.

Note that any re-working of a block without prior factory authorization will be done entirely at the user's own risk and expense.

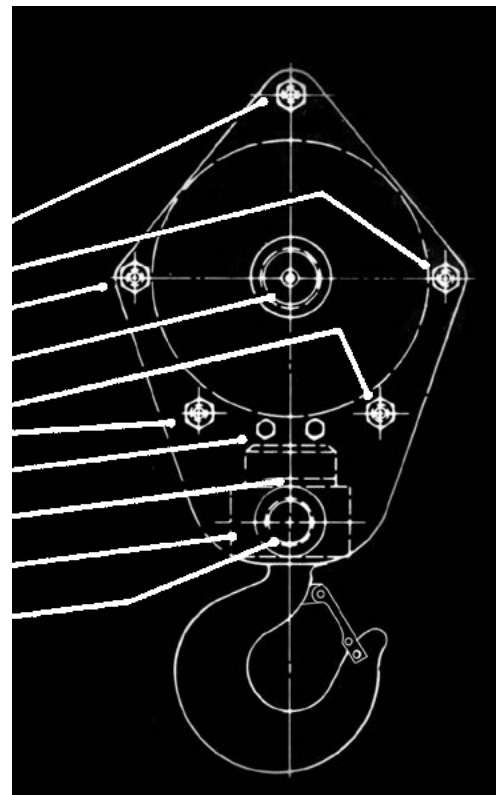

Providing innovative, safe and reliable solutions since 1764

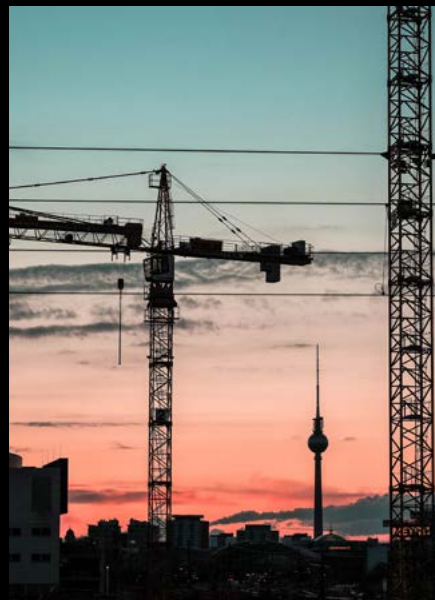

# Inspection and Maintenance

**Cheek Weight Cap Screws**

Cap screws should always be tightened down and locked with a self-locking jam nut inside the side plate, or with a lock washer located under the head of the cap screw (all the way inside the cheek weight counter-sink hole).

**Cotter Pins**

Where furnished, cotter pins must always remain in place. Replace any damaged or missing pins before resuming work.

**Load Fitting Set Screws**

These screws are staked in place by the factory. Should they attempt to back out, re-tighten and re-stake thoroughly.

NOTE: A GALLED HOOK NUT CANNOT BE FORCED WITHOUT ENDANGERING THE THREADS. In the event foreign matter has caused the nut assembly to gall, locking it in place, return the product, prepaid, to our plant. Or call us for instructions.

**All Side Nuts With Set Screws**

Where used with center pin nuts, hook trunnion pin nuts, etc., set screws will be jammed radially into the threads by the factory. Check all for tightness and tighten as necessary to re-establish the jamming action.

**All Side Nuts Without Set Screws**

Any tie bolt or other nut that does not utilize set screws should be checked to see that it remains in its original position. Re-tighten and re-stake as necessary. If still uncertain: a) tack weld any center pin nuts to their respective side plates; b) weld any trunnion nuts to the ends of the pins themselves.

**Spirolox Retaining Rings**

Where furnished on the ends of block center pins and trunnions, these rings must remain in place. If damaged or missing, contact the factory for a replacement. Do not resume work.

**Tie Bolt Nuts – Upper**

Inspect and re-tighten firmly as required. Re-stake thoroughly.

**Tie Bolt Nuts – Lower**

Re-tighten any loose nuts firmly. If originally staked, re-stake. If held by set screws, reset these screws securely.

**Trunnion Pin Nuts – Lower**

Re-tighten nut to the point where the trunnion is just able to rotate. Secure the set screw.

**Swivel Barrel Set Screws**

Check for any signs of backing out. Re-tighten and re-stake thoroughly as necessary. If you still have reservations, replace the swivel and have it returned to the factory for inspection.

## Lubrication Schedule

Lubrication Frequency		Item
Under Continuous Operating Conditions	Under Intermittent Operating Conditions	
24 hours	14 days	Swivels and swivel overhaul balls
8 hours	14 days	Blocks with bronze bushed sheaves
24 hours	14 days	Blocks with roller bearing sheaves

Lubricant: either sodium or lithium base greases may be used. Soda soap base greases are more fibrous and cohesive. Lithium soap base greases are particularly applicable where excessive moisture is present.

# Inspection and Maintenance

## Inspection and Maintenance Schedule/General

Inspection frequency	Item	What to check for	Appropriate Action
Daily	<b>Hook Latch</b>	Missing or off center	Replace immediately
		Permanent deformation or stretching	A clear indication of overload. Take out of service immediately and replace.
	<b>Hooks and Other Fittings</b>	Cracks or other defects	<p>Any suspicion of fractures calls for an immediate investigation and, if necessary, the replacement of the defective part.</p> <p>USAS B 30.5-1968 suggests that hooks should be tested at least once a year by magnafluxing, X-ray or other qualified method. Intermittent tests can be conducted, however, by the readily available, though less accurate, oil stain method. (Immerse hook in lube oil, wipe dry; whitewash surface; inspect for signs of fracture seepage.)</p>
14 days Under Continuous Operating Conditions	<b>Swivels</b>	End Play or Gap of more than 1/16" along the Axis	Remove from service immediately.
	<b>Plates</b>	Side plate spread	Indicates overload. Remove for repairs.
Looseness		Sign that retaining nuts may be backing out. Tighten and re-stake in accord with Nut/Retainer Checklist.	
30 days Under Intermittent Operating Conditions	<b>Sheaves</b>	Misalignment, as evidenced by wobble or uneven groove flange wear	Indicates severe bearing wear. Remove from service and forward to factory for repairs estimate.
		Striations or Corrugations in sheave groove	Result of rope wear. If serious, have factory remachine or replace.

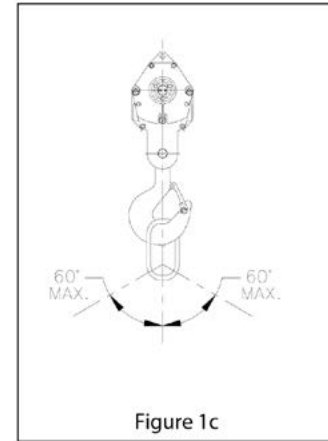
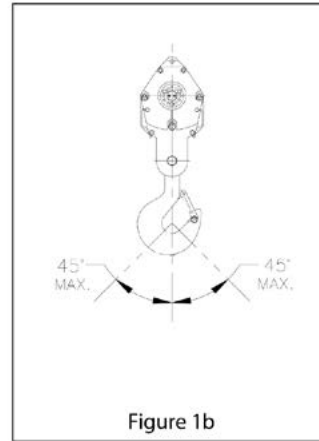
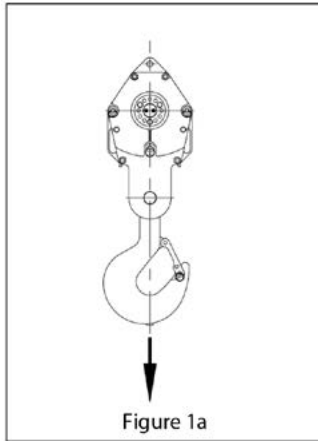
**INFORM A RIGGER – PASS THE WORD**

When using a latch to close the throat opening of the hook, care shall be taken that the rigging load is not carried by the latch. Hook latches aid in the retention of loose slings under slack rigging conditions only and are not intended to be anti-fouling devices during lifting. Such fouling is extremely dangerous and shall be avoided by proper rigging and controlled lifting dynamics.

- **Never use a worn-out or damaged crane block.** Avoid structural or mechanical failure.

Each day before use, the crane block and its fasteners and attachments shall be inspected for damage or defects by a competent person designated by the employer. Additional inspections shall be performed during crane block use where service conditions warrant. Damaged or defective crane blocks shall be immediately removed from service. In addition to the daily inspection, a thorough periodic inspection shall be made on a regular basis, to be determined on the basis of (A) frequency of crane block use; (B) severity of service conditions; (C) nature of lifts being made; and (D) experience gained on the service life of crane blocks used in similar circumstances.

Such inspections shall in no event be at intervals greater than once every 12 months.

The following findings shall be cause for crane block removal from service until repaired or replaced;

- Elongated center pin and hook trunnion holes exceeding 5% of original diameter,
- Bent side plates,
- Severe corrosion pitting,
- Corroded hook threads,
- Bent or twisted hook,
- Welding on hook,
- Damaged or dysfunctional hook latch,
- Cracks in sheaves, side plates, cheek weights, center pins, hook trunnion, dead end connections and hook,
- Material loss due to wear exceeding 10% of original section,
- Sheave wobble,
- Deeply corrugated (not imprinted) sheave grooves or,

- Sheave wire rope groove diameter smaller than 2.5% or greater than 10% of the nominal wire diameter,
- Missing or damaged retaining nuts, snap rings, set screws, cotter pins, tie bolts, hook nut cap screws and lock wire or,
- Missing or illegible rating and warning tags.

The following findings shall be cause for crane block removal from service until corrected;

- Loosened tie bolt nuts, center pin round nuts, cheek weight cap screws and hook nut cap screws. Tie bolt nuts to be torqued to 35-40 ft-lb and restaked, all other fasteners wrench tight.
- Lack of sheave and hook bearing lubrication. Continuous operation: lubricate bushings every 8 hours and roller bearings every 24 hours. Intermittent operation: lubricate bushings and bearing every 14 days.
- **Never use a crane block in extreme temperatures.** Sudden failure can occur.

Crane blocks shall not be heated above 180 degrees F. Crane block Working Load Limit is valid between 180 degrees F and service temperature given on the identification tag with normal lifting precautions.

Additional lifting precautions are required below the service temperature given on the identification tag because cold temperature begins to affect the crane block material properties.

Lifting above 75% of the Working Load Limit (WLL), at temperatures between the service temperature given on the identification tag and -40 degrees F, must be done at a slow and steady rate to avoid stress spikes common in normal hoisting dynamics.

75% of the WLL must not be exceeded, when lifting in temperatures below -40 degrees F.

- **Never use a crane block in alkaline or acidic conditions.**

Gunnebo Industries Crane Blocks shall not be used in alkaline or acidic conditions. Resulting metal embrittlement and accelerated corrosion can cause sudden failure.

## INFORM A RIGGER – PASS THE WORD

### Crane Block Warnings and Use Limitations

This document contains warnings and use limitation information applicable to Gunnebo Industries Crane Blocks and is furnished with all Gunnebo Industries shipments. Crane Block distributors and lift system manufacturers must pass on this information in their warnings and use limitation literature where Gunnebo Industries Crane Blocks are involved.

#### Protect yourself and others

- **NEVER** use a crane block without training.
- **ALWAYS** inform yourself ... Ask your employer for the manufacturer's crane block use limitations.
- **ALWAYS** comply with applicable Country regulations.
- **ALWAYS** know load weight.
- **NEVER** use a crane block without a legible rated load tag.
- **NEVER** overload a crane block.
- **NEVER** ride on a crane block or load.
- **NEVER** use an improperly rigged crane block.
- **NEVER** use a worn – out or damaged crane block.
- **NEVER** use a crane block in extreme temperatures.
- **NEVER** use a crane block in acidic conditions.

**Never use a crane block without training.** OSHA regulation requires responsible work practice.

"The employer shall permit only those employees qualified by training or experience to operate equipment or machinery." OSHA 1926.20 (b) (4).

"Employee shall be knowledgeable of all warnings and cautions on the crane block." - OSHA 1910 Subpart N and 1926 Subpart N.

Employee training should include information given in OSHA training literature, ASME B30.10- 2005 Hook Safety Standards, ASME B30.5-2007 Mobile and Locomotive Cranes and Gunnebo Industries DVD of "Recommended Inspection Practices for Johnson Lifting Accessories" and this document.

**Always inform yourself.** Ask your employer for crane block safe use instruction.

"The employer shall instruct each employee in the recognition and avoidance of unsafe conditions and the regulations applicable to his work environment to control or eliminate any hazards or other exposure to injury."-OSHA 1926.21 (b) (2).

**Always comply with applicable Country regulations.** Federal and Local regulations govern worksite activity.

Understand all governing laws and safety standards before use of crane blocks. OSHA 1910.180 and 1926.550 regulates product requirements, operating practices, product identification, inspection requirements, and use limitation obligations.

"If a particular standard is specifically applicable to a condition, practice, means, method, operation, or process, it shall prevail over any different general standard...." OSHA 1910.5 (c) (1).

Contact OSHA at 800-321-6742, [www.osha.gov](http://www.osha.gov) and ASME at 800-843-2763, [www.asme.org](http://www.asme.org) for reference assistance.

**Always know load weight.** Avoid crane block failure.

The weight of the load shall be within the rated load of the crane block.

Weight of the load to be lifted must be known for determination of proper reeving and rigging of crane block.

- **Never use a crane block without a legible identification tag.** Crane block tag is required to insure proper block application.

"All hook and ball assemblies and load blocks shall be labeled with their rated capacity and weight."- ASME B30.5-1.7.6.

- **Never overload a crane block.** Understand Working Load Limits. Overload can cause crane block failure or permanent damage.

Maximum crane block Working Load Limit (Rated Load) is valid only when all crane block sheaves are reeved. Partial reeving requires a Maximum Working Load Limit reduction;  $WLL_{PR} = WLL_{MAX}$  times the No. of reeved sheaves divided by the maximum No. of sheaves.

- **Never ride on a crane block or load.** Avoid death or injury.

"All employees shall be kept clear of loads about to be lifted and of suspended loads." -OSHA 1926.550 (a) (19).

"No hoisting, lowering, swinging or traveling shall be done while anyone is on the load or hook assembly. " -OSHA 1910.180 (h) (3) (v).

The use of a crane block to hoist employees on a personnel platform is prohibited. Except when the erecting, use, and dismantling of conventional means of reaching the worksite, such as a personnel hoist, ladder, stairway, aerial lift, elevating work platform or scaffold, would be more hazardous or is not possible because of structural design or worksite conditions. - OSHA 1926.550 (g) (2).

Follow Crane Operators' Manual for personnel lifting requirements.

- **Never rig a crane block to a crane or a load improperly.** Avoid dropped loads and crane block damage.

#### Crane block shall not be;

- allowed to "two-block",
- unsymmetrically reeved,
- used with reeving off lead greater than 2.5 degrees,
- used with a single part of line unless expressly permitted,
- used as a wrecking ball,
- used to drag a load,
- subjected to high vibration,
- immersed in water.

Hook load rigging shall be centered in the base (bowl/saddle) of the hook to avoid point loading of the hook and rigging disengagement. (See figure 1a, 1b, & 1c.)

Copyright © Gunnebo Industries  
All rights reserved.

01/10  
P/N 63516 REV -

# "Quick Reeve" Product Advisory

AVOID BODILY INJURY. Read and understand this safety advisory before attempting to install or remove wire rope from a Gunnebo Industries Model QRJ "Quick Reeve" block.

This advisory is intended for the attention of all "Quick Reeve" Crane Block users and should be forwarded to the field with the product.

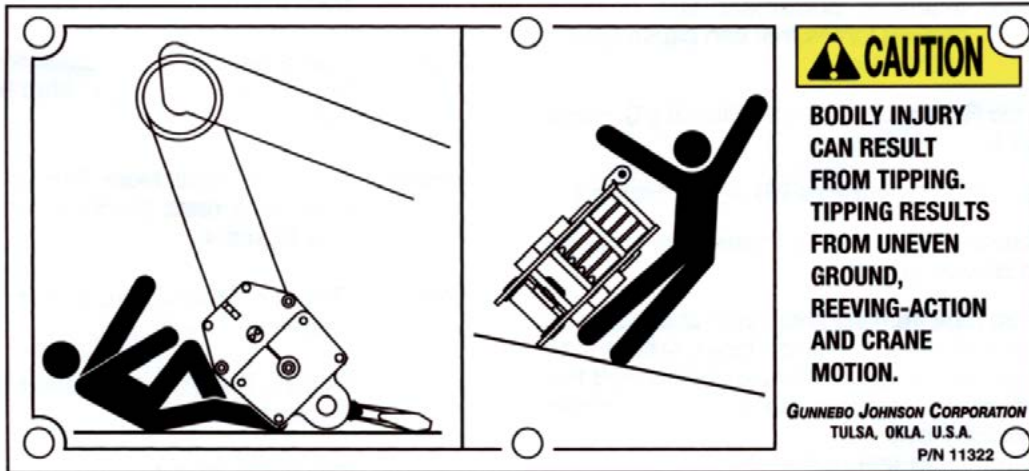

This advisory is a **CAUTION** concerning the potential for **BODILY INJURY** resulting from tipping of the "Quick Reeve" Crane Block during crane to block reeving. Crane block tipping can result from uneven ground, reeving action and crane motion.

The Gunnebo Industries "Quick Reeve" Crane Block is stable, when positioned and reeved, in accordance with the following instructions.

Contact the factory at 1-800-331-5460 with any questions or for additional copies of this safety advisory. P/N 51695, Rev. C Form PSA-1, Rev. 01/08

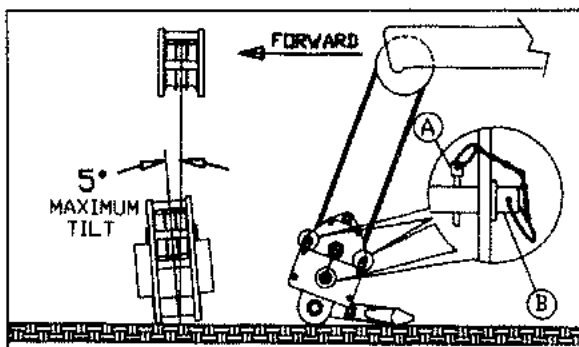

Figure 1

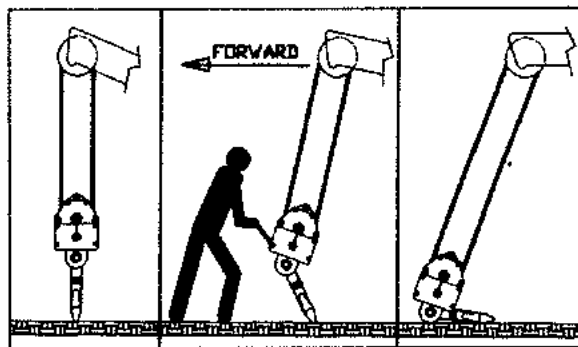

Figure 2

Figure 3

Figure 4

P/N 51695, Rev. C  
 Form PSA-1, Rev. 02/06



**INFORM A RIGGER – PASS THE WORD**

# Overhaul Ball Warnings and Use Limitations

This document contains warnings and use limitation information applicable to Gunnebo Industries Overhaul Ball Assemblies and is furnished with all Gunnebo Industries shipments. Overhaul Ball distributors and lift system manufacturers must pass on this information in their warnings and use limitation literature where Gunnebo Industries Overhaul Ball Assemblies are involved.

**Protect yourself and others**

- **NEVER** use an overhaul ball without training.
- **ALWAYS** inform yourself ... Ask your employer for the manufacturer's overhaul ball use limitations.
- **ALWAYS** comply with applicable Country regulations.
- **ALWAYS** know load weight.
- **NEVER** use an overhaul ball without a legible rated load tag.
- **NEVER** overload an overhaul ball.
- **NEVER** ride on an overhaul ball or load.
- **NEVER** use an improperly rigged overhaul ball.
- **NEVER** use a worn – out or damaged overhaul ball.
- **NEVER** use an overhaul ball in extreme temperatures.
- **NEVER** use an overhaul ball in acidic conditions.

- **Never use an overhaul ball without training.** OSHA regulation requires responsible work practice.

“The employer shall permit only those employees qualified by training or experience to operate equipment or machinery.” - OSHA 1926.20 (b) (4).

“Employee shall be knowledgeable of all warnings and cautions on the overhaul ball.” - OSHA 1910 Subpart N and 1926 Subpart N.

Employee training should include information given in OSHA training literature, ASME B30.10-2005 Hook Safety Standards, ASME B30.5-2007 Mobile and Locomotive Cranes and Gunnebo Industries DVD of “Recommended Inspection Practices for Johnson Lifting Accessories” and this document.

- **Always inform yourself.** Ask your employer for overhaul ball safe use instruction.

“The employer shall instruct each employee in the recognition and avoidance of unsafe conditions and the regulations applicable to his work environment to control or eliminate any hazards or other exposure to injury.” - OSHA 1926.21 (b) (2).

- **Always comply with applicable Country regulations.** Federal and local regulations govern worksite activity.

Understand all governing laws and safety standards before use of overhaul ball. OSHA 1910.180 and 1926.550 regulates product requirements, operating practices, product identification, inspection requirements, and use limitation obligations.

“If a particular standard is specifically applicable to a condition, practice, means, method, operation or process, it shall prevail over any different general standard....” - OSHA 1910.5 (c) (1).

Contact OSHA at 800-321-6742, [www.osha.gov](http://www.osha.gov) and ASME at 800-843-2763, [www.asme.org](http://www.asme.org) for reference assistance.

Copyright © Gunnebo Industries  
All rights reserved.

01/10  
P/N 63517 REV -

- **Always know load weight.** Avoid overhaul ball failure.

The weight of the load shall be within the rated load of the overhaul ball.

Weight of the load to be lifted must be known for determination of proper rigging of overhaul ball.

- **Never use an overhaul ball without a legible identification tag.** Overhaul ball tag is required to insure proper ball application.

All hook and ball assemblies and load blocks shall be labeled with their rated capacity and weight. - ASME B 30.5-1.7.6.

- **Never overload an overhaul ball.** Understand Working Load Limits. Overload can cause overhaul ball failure or permanent damage.

- **Never ride on an overhaul ball or load.** Avoid death or injury.

“All employees shall be kept clear of loads about to be lifted and of suspended loads.” - OSHA 1926.550 (a) (19).

“No hoisting, lowering, swinging or traveling shall be done while anyone is on the load or hook assembly.” - OSHA 1910.180 (h) (3) (v).

The use of an overhaul ball to hoist employees on a personnel platform is *prohibited*. Except when the erecting, use, and dismantling of conventional means of reaching the worksite, such as a personnel hoist, ladder, stairway, aerial lift, elevating work platform or scaffold, would be more *hazardous* or is *not possible* because of structural design or worksite conditions.

Follow crane operator’s manual for proper personnel lifting requirements.

- **Never rig an overhaul ball to a crane or a load improperly.** Avoid dropped loads and overhaul ball damage.

Overhaul ball shall not be;

- allowed to “two-block”,
- used as a wrecking ball,
- used to drag a load,
- subjected to high vibration or
- immersed in water.

Hook load rigging shall be centered in the base (bowl/ saddle) of the hook to avoid point loading of the hook and rigging disengagement. (See figure 1a, 1b, & 1c).

When using a latch to close the throat opening of the hook, care shall be taken that the rigging load is not carried by the latch. Hook latches aid in the retention of loose slings under slack rigging conditions only and are not intended to be anti-fouling devices during lifting. Such fouling is extremely dangerous and shall be avoided by proper rigging and controlled lifting dynamics.

6

## INFORM A RIGGER – PASS THE WORD

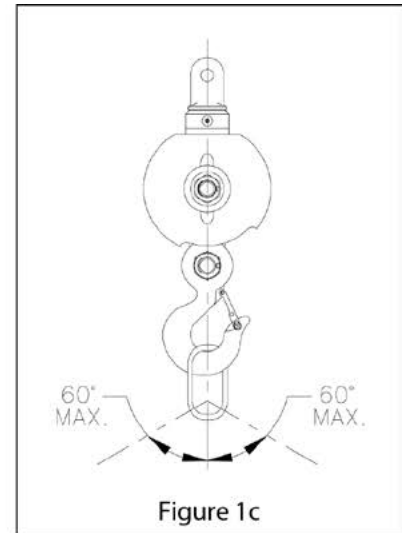
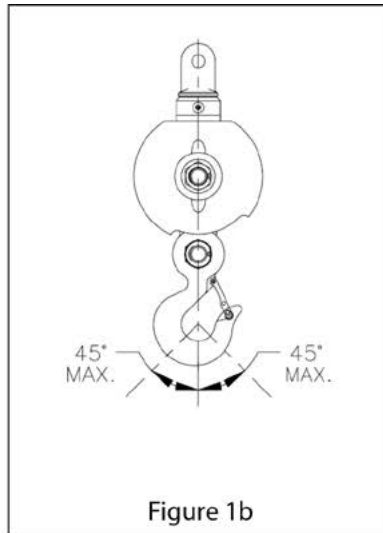
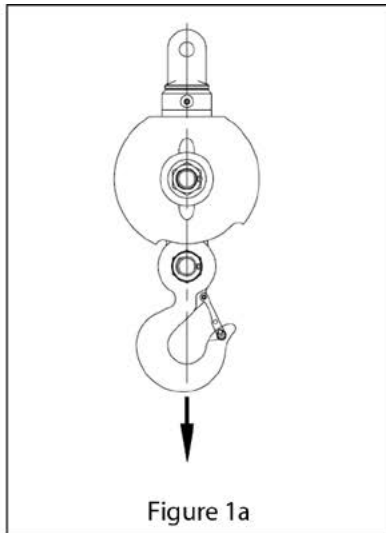

- **Never use a worn-out or damaged overhaul ball.** Avoid structural or mechanical failure.

Each day before use, the overhaul ball and its fasteners and attachments shall be inspected for damage or defects by a competent person designated by the employer. Additional inspections shall be performed during overhaul ball use where service conditions warrant. Damaged or defective overhaul ball shall be immediately removed from service. In addition to the daily inspection, a thorough periodic inspection shall be made on a regular basis, to be determined on the basis of (A) frequency of overhaul ball use; (B) severity of service conditions; (C) nature of lifts being made; and (D) experience gained on the service life of overhaul ball used in similar circumstances. Such inspections shall in no event be at intervals greater than once every 12 months.

The following findings shall cause overhaul ball removal from service until replaced or repaired;

- Elongated ball pin holes, hook latch pin holes and swivel eye exceeding 5% of original diameter,
- Swivel end play gap exceeding .08". Excessive end play indicates damaged internal set screw, (See Figure 2)
- Bent connector plates,
- Severe corrosion pitting,
- Bent or twisted hook,
- Welding on hook,
- Damaged or dysfunctional hook latch,
- Cracks in connector plates, ball casting, ball pin, hook latch pin, swivel and hook,
- Material loss due to wear exceeding 10% of original section,
- Loose, missing or damaged retaining nuts, cotter pins or swivel set screws or
- Missing or illegible rating and warning tags.

The following findings shall cause overhaul ball removal from service until corrected;

- Lack of swivel bearing lubrication. Continuous operation: Lubricate every 24 hours. Intermittent operation: Lubricate every 14 days.
- **Never use an overhaul ball in extreme temperatures**  
Sudden failure can occur.

Overhaul ball shall not be heated above 180 degrees F. Overhaul ball Working Load Limit is valid between 180 degrees F and service temperature given on the identification tag with normal lifting precautions.

Additional lifting precautions are required below the service temperature given on the identification tag because cold temperature begins to affect the overhaul ball material properties.

Lifting above 75% of the Working Load Limit (WLL), at temperatures between the service temperature given on the identification tag and -40 degrees F, must be done at a slow and steady rate to avoid stress spikes common in normal hoisting dynamics.

75% of the WLL must not be exceeded, when lifting in temperatures below -40 degrees F.

- **Never use an overhaul ball in alkaline or acidic conditions.**

Overhaul balls shall not be used in alkaline or acidic conditions. Resulting metal embrittlement and accelerated corrosion can cause sudden failure.

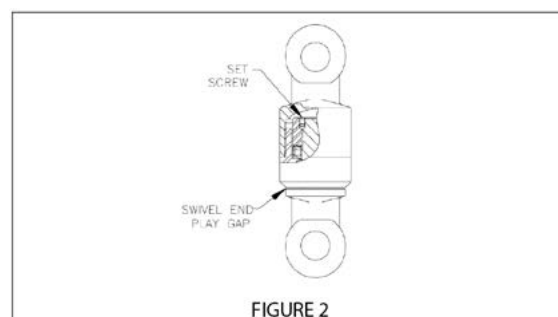

## Wedge Sockets

**Gunnebo Industries open wedge sockets combine positive attachment with optimum versatility.** Easy-to-change Gunnebo Industries wedge sockets consist of a normalized and tempered steel body, a steel bar stock pin with cotters, and a ductile iron wedge to specific wire rope size. Together, wedge and body act as a vise which grips the wire rope and locks it in place.

**Gunnebo Industries wedge sockets may be used with multiple sizes of wire rope.** To switch from an overhaul ball application calling for a 7/8-inch wire rope to a block application calling for a 1-inch rope, it is not necessary to buy a complete wedge socket. A simple change-out of wedges will suffice. Of the 18 models of wedge sockets offered by Gunnebo Industries, all can be adapted to at least two sizes of wire rope. The WS-4 and WS-5, in fact, will adapt to three sizes.

**Be sure that the wedge is correct for the wire rope size.** Each socket manufactured by Gunnebo Industries has a model number and acceptable rope sizes cast into its body. Each wedge has the rope size and particular socket model it will fit. Wedges are also coded by means of color. Red indicates that the wedge is for the largest size of wire rope stated on its socket. Green indicates that the Wedge is for the smallest size of rope stated on its socket. Blue indicates that the wedge is a rope size of 9/16 inches; black for 7/16 inches.

**When using wedge sockets note that two precautions should be taken.**

1. Make sure that a sudden jolt or impact does not dislodge a wedge. When installing wire rope, always pre-load the wedge with wire rope in place. Check frequently to re-tighten or re-position as necessary.
2. Make allowance for the crimping effect common with all types of wedge sockets. Experience shows that it will reduce the Safe Working Limit of a line by 20 percent.

### Effect of Crimping Action of Wedge Socket on Safe Working Limits of Wire Rope\*

Wire Rope O.D. (Inches)	Weight Per Foot (Pounds)	Line S.W.L. Without Wedge Socket (short tons)	Line S.W.L. With Wedge Socket (short tons)
3/8" (10 mm)	26	1.6	1.3
1/2" (13 mm)	46	2.9	2.3
9/16" (14 mm)	59	3.6	2.9
5/8" (16 mm)	72	4.5	3.6
3/4" (19 mm)	1.04	6.4	5.1
7/8" (22 mm)	1.42	8.7	7.0
1" (26 mm)	1.85	11.2	9.0
1-1/8" (32 mm)	2.34	14.1	11.3
1-1/4" (32 mm)	2.89	17.4	13.9
1-1/2" (38 mm)	4.16	24.7	19.8

\*Figures based on 20% reduction in safe working limit of single line having 4 to 1 design factor.

**INFORM A RIGGER – PASS THE WORD**

# Snatch Block Warnings and Use Limitations

This document contains warnings and use limitation information applicable to Gunnebo Industries Snatch Blocks and is furnished with all Gunnebo Industries shipments. Component distributors and lift system manufacturers must pass on this information in their warnings and use limitation literature where Gunnebo Industries Snatch Blocks are involved.



## Protect yourself and others

- **NEVER** use a Snatch Block without training.
- **ALWAYS** inform yourself... Ask your employer for the Snatch Block safe use instructions.
- **ALWAYS** comply with applicable Federal and local regulations.
- **ALWAYS** know applied lift system load.
- **NEVER** use a Snatch Block without a legible product identifier.
- **NEVER** overload a Snatch Block.
- **NEVER** ride on a Snatch Block or load.
- **NEVER** rig a Snatch Block improperly.
- **NEVER** use a worn – out or damaged Snatch Block.
- **NEVER** use a Snatch Block in extreme temperatures.
- **NEVER** use a Snatch Block in alkaline acidic conditions.

- **Never use a Snatch Block without training.** OSHA regulation requires responsible work practice.

“The employer shall permit only those employees qualified by training or experience to operate equipment or machinery” – OSHA 1926.20 (b) (4).

Employee training should include information given in OSHA training literature, ASME B30.26 - 2010 “Rigging Hardware” standard, lift system manufacturer’s literature, Gunnebo Industries DVD of “Recommended Inspection Practices for Johnson Lifting Accessories”, and this document.

- **Always inform yourself.** Ask your employer for Snatch Block safe use instruction.

The employer shall instruct each employee in the recognition and avoidance of unsafe conditions and the regulations applicable to his work environment to control or eliminate any hazards or other exposure to illness or injury” – OSHA 1926.21 (b) (2).

- **Always comply with applicable Federal and local regulations.** Federal and local regulations govern worksite activity.

Understand all governing laws and safety standards before use of Snatch Blocks in lift systems.

“If a particular standard is specifically applicable to a condition, practice, means, method, operation, or process, it shall prevail over any different general standard...” — OSHA 1910.5 (c) (1).

Contact OSHA at (800) 321-6742, or [www.OSHA.gov](http://www.OSHA.gov) and ASME at (800) 843-2763, or [www.ASME.org](http://www.ASME.org) for reference assistance.

- **Always know applied lift system load.** Avoid improper Snatch Block selection.

Lift system load (LSL) applied to the snatch block fitting is based upon line pull (LP) and load factor (LF) for a given lift angle (LA).

Maximum LSL applied to snatch block fitting must be known for proper snatch block selection.

LSL is calculated by the following formula:

$LSL = (LP) * (LF)_{LA}$  See illustration and table in Figure No. 1. LSL must be calculated for each snatch block in the lift system.

Snatch Block Working Load Limit (WLL) with appropriate design factor shall be equal to or greater than the corresponding maximum LSL.

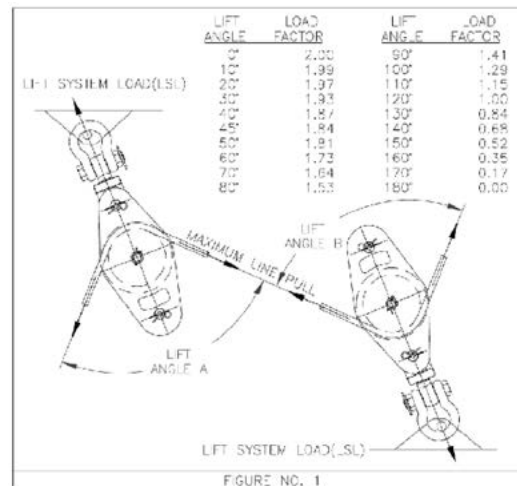

- **Never use a Snatch Block without a legible product identifier.** Product Identification is required to insure proper application.

Snatch Blocks have a product identifier giving WLL, design factor, wire rope range, and important user warnings. The information is required for confirmation of proper application prior to use.

Example of Product Identifier





6

# Johnson Sheaves

- Forged sheaves • Cast sheaves •
- Machined sheaves •



**GUNNEBO**  
Industries

**JOHNSON**

## Johnson Sheaves

Johnson Sheaves by Gunnebo Industries	7:3
Applications	7:4
Sheaves Overview	7:5
Information needed for quotation	7:6
Tapered roller bearing sheaves	7:7
Finish bored sheaves	7:8 - 7:9
Sheaves with PD 18x steel wire rope diameter	7:10
Sheaves with PD 19x steel wire rope diameter	7:11
Sheaves with PD 20x steel wire rope diameter	7:12
Sheaves with PD 22x steel wire rope diameter	7:13
Sheaves with PD 24x steel wire rope diameter	7:14
Sheaves with PD 25x steel wire rope diameter	7:15

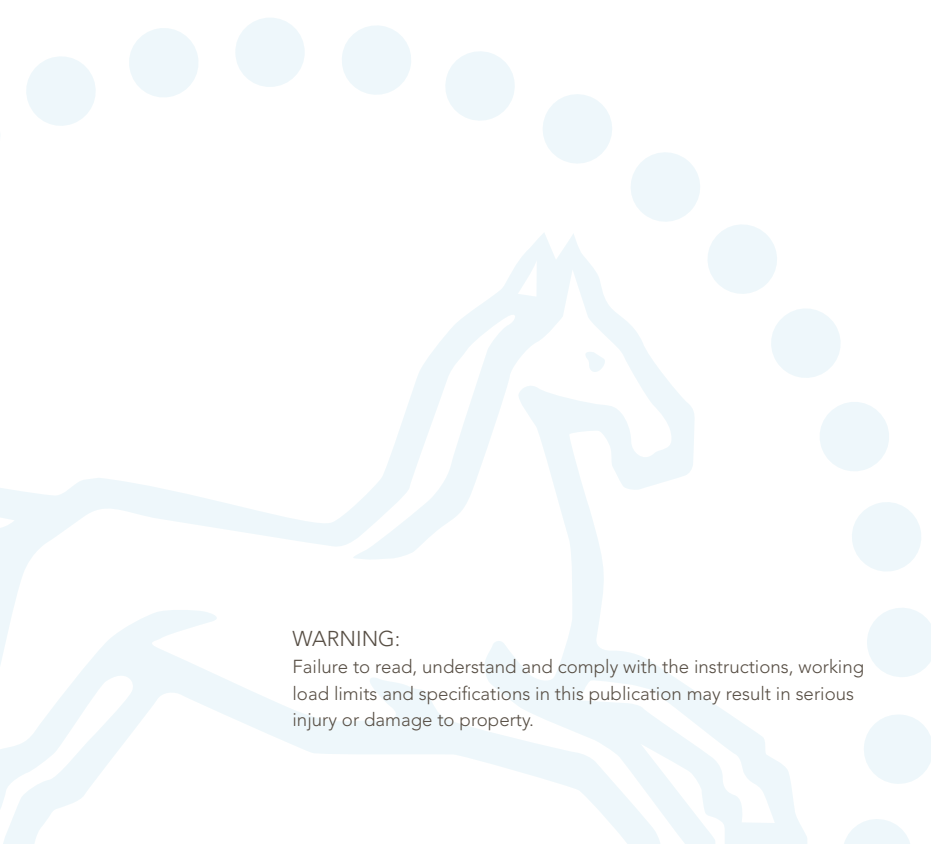

**WARNING:**  
Failure to read, understand and comply with the instructions, working load limits and specifications in this publication may result in serious injury or damage to property.

## A solution provider since 1764

*With more than 80 years experience in the sheaves business and a 250-year legacy in the lifting and rigging industry, Gunnebo Industries has an in-depth knowledge of the industry, and an extensive product offering to all markets and applications.*

- At Gunnebo Industries, we develop and manufacture sheaves for all purposes. It is our commitment to always **provide optimized solutions** for our customers' specific needs. Regardless if it's time, price, weight, volume or something else, we will supply the best possible solution based on application and need.
- With production facilities in USA and Europe, **we serve customers on a global scale**, always close, for the best possible support.
- We have one of the **world's largest engineering** staffs within our field, in order to be able to offer **flexible design, quick delivery and long-lasting high quality** products. The combination of our long heritage of technical knowhow and innovation, together with an extensive engineering team, makes our offering unique.
- We offer our Johnson sheaves **from 3", up to 295" and 44,000 lb**. We have standard sheaves as well as customized solutions. We offer sheaves in all geographies, for every application. Our sheaves have a proven track record and have been in use in the industry for decades.

As experts within the sheaves business, we support our customers to find the best solution for their specific need, every day, everywhere.



# Johnson Sheaves by Gunnebo Industries

## Solutions for every application and all conditions

---

Johnson sheaves are highly trusted, preferred and utilized by many crane and rig manufacturers around the world. Our sheaves are designed to optimize performance and quality, providing a number of advantages to our customers;

### Superior durability

- Made of high-strength materials to handle tough applications
- Optimized material specification enables the best possible weight, sheave performance and service life

### Optimal design

- Superior stress flow to assure high resistance against fatigue
- Optimized weight to fit project needs
- Adjustable designs to provide capacity in extreme load case
- Design to optimize product functionality

### Reliable delivery

- Flexibility in production to shorten lead-times
- Custom sheaves can be made in small and large quantities with virtually no tooling cost
- We can also build to your forecast to maximize the efficiency of your production schedule and shorten lead time

### Longer life

- Deep hardening of the sheave groove extends life of the rope and the sheave
- Broad range of hardnesses to accommodate wire and sheave properties for maximum service life
- Our unique concurrent hardening can be provided for forged sheaves 24" - 72" which provides the additional benefit of hardened groove walls

### World-class engineering team

- Engineering team with comprehensive know-how of the rules and regulations for most class societies - DNV GL, ABS, API, CCS, BV, LRS, Machine Directive
- Capacity to provide solutions for extraordinary project specifications, up to 44,000 lb and 295"
- Specialists in delivering large sheave diameters with FEM analysis. Design reports available upon request



## Applications

Gunnebo Industries offers a wide range of sheaves, for all applications. Below are some of the most common applications where we serve our customers with different sheaves. Sheaves can be manufactured for ForgeFab, cast ductile iron, cast steel or welded assemblies depending on the size, quantity, delivery and application requirements.

**Offshore crane sheaves** – Specially designed to handle heavy loads and large fleet angles. Can be designed to meet the requirements of API 2C, ABS, DNV, LR, BV and CCS. Sizes up to 295" in diameter available.

**Drilling and well servicing sheaves** – Manufactured to API specification 8C to withstand the high intensity application on drilling and well servicing rigs. These sheaves are used in crown assemblies, drilling/traveling blocks and tubing blocks. These are available from 18" - 78" in diameter.

**Riser tensioning and motion compensation sheaves** – Fully optimized for the high load and long life requirements of an offshore environment. Available up to 108" outer diameter.

**Launch and recovery systems (LARS) sheaves** – Optimized weight/capacity ratio and come in standard outer diameter size of 62", or as customized sizes. These are manufactured with a standard groove size with other sizes available upon request.

**Mobile crane sheaves** – Used in boom points, boom extensions and hook blocks. Available in variety of sizes from 10" to 48" in diameter and can be grooved for up to 1-1/2" wire rope ideally suited for heavy lifting.

**Overhead crane sheaves** - Used both in upper sheave nests and hook blocks and are designed for continuous heavy use. Sizes available from 5" up to 48" in diameter.

**Mooring sheaves** - Designed to be used in an offshore environment for towing, pulling and anchoring of ships. Available in 18" to 60" in diameters.

**Deflector sheaves** - Used in a fairleader block to accommodate the directional change of the wire rope. Available in 3" up to 120" in diameter.

**General industrial sheaves** – Built for a high variety of applications where wire rope is used to lift or pull such as tilting and lifting of flare stacks, roll on and roll off truck bodies, tower erection and anywhere the change of direction of wire rope is required.



## High quality sheaves - flexible design

All sheaves are designed and manufactured according to customer requirements and applicable class regulations. The sheaves can be supplied with bearings, bushings or as plain bore. If required, the groove for the steel wire rope can be hardened up to a hardness of 54 RC. Sheaves can be compliant with the following classes: DNV GL, ABS, Lloyd's Register, BV, CCS, API.

### Forged sheaves

Our forged sheaves are field proven and have a short manufacturing time. Forging provides good material flow in the groove providing longer service life for both sheave and wire rope.

- Size: 10" - 72"
- Ideal for any application, especially high use applications
- 2 - 6 weeks manufacturing time. Suitable for any quantity
- Steel construction sustains low temperatures

### Cast sheaves, iron

We offer cast sheaves in iron, with a flexible design in any size. Cast design provides a smooth stress flow giving long durability.

- Size: 8" - 295"
- Flexible design, casting provides smoother stress flow, lower weight and can be optimized to specific applications
- 6 - 14 weeks manufacturing time. Minimum order might apply

### Cast sheaves, steel

Our cast sheaves, made in steel, enables a flexible design and are available in any size. These have similar advantages as to our casted sheaves in iron.

- Size: 8" - 295"
- Flexible design, no welds means smoother stress flow
- 6 - 14 weeks manufacturing time. Minimum order might apply
- Sustains low temperatures

### Machined sheaves, steel

Our machined sheaves, in steel, are field proven and have a fast delivery time. They are available in any size and can endure low temperature.

- Size: < 79"
- Manufacturing lead times from 2 week. Suitable for small quantities
- Sustains low temperatures

### Optional features:

- Custom design to customer shaft, bearing mounting, hub, sheave O.D. or wire rope size requirement
- Modifications as required to API and other applicable industry standards
- Electroplating, inorganic zinc compound and other corrosion resistant coatings available
- Hub-located grease fittings
- AISE No. 6 specifications
- Cold weather properties
- Special shaft, furnished for any sheave listed

## ForgeFab® sheaves

Our ForgeFab sheaves have been the first choice for many crane and rig manufacturers for decades. Our unique production process supports quick deliveries without compromising on the high quality of our sheaves.

### Unique production process for a long product life

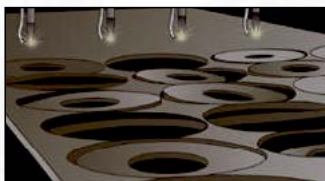

Each ForgeFab sheave begins as precision disc cut from superior chemistry alloy steel plate

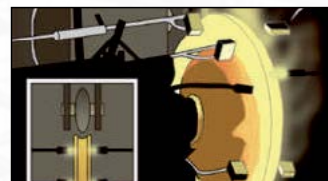

The steel disc is heated to forging temperature and its edge rotated against a system of staged rollers to forge the sheave rim and wire rope groove



A precisely machined hub is arc welded to the forged disc. A variety of welding techniques is used, including: fillet, submerged arc, partial penetration and full penetration, depending on the application

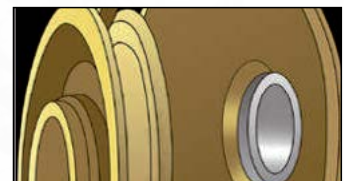

The result: A precision built ForgeFab sheave, resistant to wear giving a long product life span as well as decreased wear on the wire rope

### ForgeFab concurrent hardened sheaves

Concurrent hardening up to 47 RC Strengthens groove as well as entire flange and penetrates deeply into webbing to handle the most difficult applications. (24" to 78" diameter)



### ForgeFab flame hardened sheaves

Flame hardened to minimum 35 RC Toughens the groove for long life in most applications. (16" to 24" in diameter)



## Information needed for quotation

### Dimensional information

- Wire line diameter
- Sheave outside diameter (A or OD)
- Bore size, if plain or finished bore (E)
- Hub width (G)
- Hub outside diameter (T)
- Shaft size with bearing (E)
- Rim width (C)
- Tread diameter (TD)

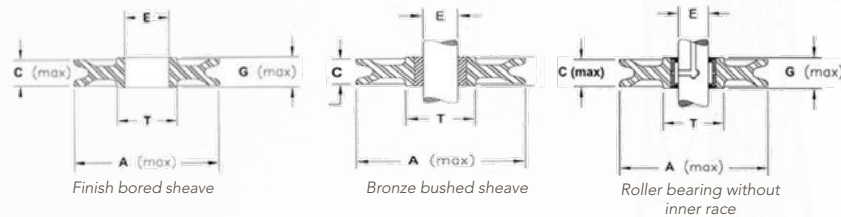

### Bearing options

- Finish/plain bore
- Bronzed bushing
- Roller bearing
- Tapered roller bearing
- Ball bearing
- Full complement cylindrical roller bearing

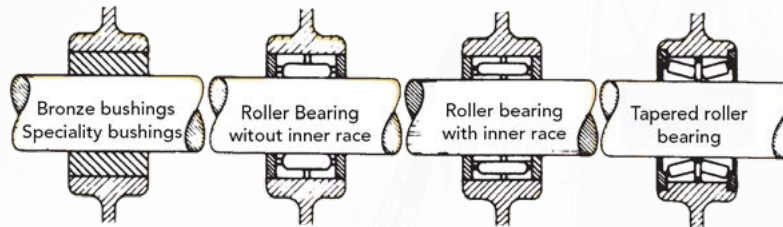

A full range of standard bronze bushing and roller bearing models is also available, as well as custom sizes.

### Type of application

- Description
- Line load
- Line speed
- Degree of wrap
- Fleet angle
- Weight restrictions
- Pitch Diameter (PD)

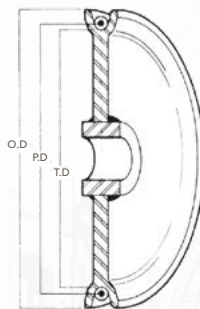

### Are there other requirements?

- Flame hardened groove
- Hardness level
- Paint or finish requirements
- DVR (Design Verification Review) by a 3rd party
- Third party inspection/approval

## Tapered roller bearing sheaves

Rim width (not shown) allows for adequate running clearance.

To order, please specify; nominal sheave O.D., model number and wire rope size.

Wire Wrap: 180° contact around sheave.  
 Bearing: Tapered Roller Bearing.  
 Surface Coating: Standard Enamel with or 2 or 3 coat marine system available upon request.  
 Hardening of Wire Groove: Flame hardened to a minimum 35 Rc. Concurrent hardening upon request.  
 Certificate: Certification according to ABS, API-8C, BV, CCS, DNVGL or Lloyds on request.

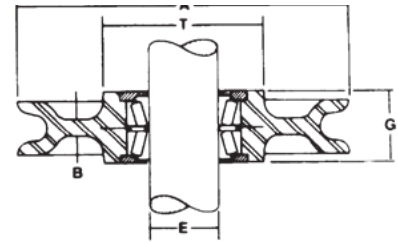

Art.number	Code	Material	Wire Rope Size		A Nominal O.D. (inch)	E Shaft size (inch)	G Hub width (inch)	T Hub O.D. (inch)	B Web (inch)	Weight lb
			Min. (inch)	Max. (inch)						
452254	16-25T	F.F.	1/2	3/4	16	2.124	2.125	4.750	.750	52
452255	18-25T	F.F.	1/2	7/8	18	2.124	2.125	4.750	.750	64
453960	18-25TM	F.F.	5/8	1-1/8	18	2.624	2.875	5.500	.750	66
452246	18-250T	F.F.	5/8	1-1/8	18	4.249	3.375	8.500	.750	71
452256	20-25T	F.F.	1/2	7/8	20	2.124	2.125	4.750	.750	80
453961	20-25TM	F.F.	5/8	1-1/8	20	2.624	2.875	5.500	.750	82
452247	20-250T	F.F.	5/8	1-1/8	20	4.249	3.375	8.500	.750	86
452257	24-25T	F.F.	5/8	7/8	24	2.124	2.125	4.750	.750	111
453962	24-25TM	F.F.	5/8	1-1/8	24	2.624	2.875	5.500	.750	113
455166	24-240T	F.F.	5/8	1-1/8	24	4.249	3.500	8.500	.750	123
452248	24-250T	F.F.	5/8	1-1/8	24	4.249	3.375	8.500	.750	120
452249	26-250T	F.F.	5/8	1-1/8	26	4.249	3.375	8.500	.750	138
455167	28-240T	F.F.	5/8	1-1/8	28	4.249	3.500	8.500	.750	160
452250	30-250T	F.F.	1	1-3/8	30	4.249	3.375	8.500	1.000	217
452258	30-350T	F.F.	1-1/4	1-1/2	30	6.499	3.750	11.500	1.250	232
455168	34-250T	F.F.	1-1/8	1-3/8	34	4.249	3.375	8.500	1.000	280
452259	36-350T	F.F.	1-1/4	1-5/8	36	6.499	3.750	11.500	1.250	385
455169	42-340T	F.F.	1-3/8	2	42	6.499	3.750	11.500	1.500	620
452260	42-350T	F.F.	1-3/8	2	42	6.499	3.750	11.500	1.500	623
452261	48-350T	F.F.	1-3/8	2	48	6.499	3.750	11.500	1.500	645
455170	52-550T	F.F.	1-3/8	2	52	7.999	3.750	14.000	1.500	936
458453	52-560T	F.F.	1-3/8	2-1/4	52	9.249	4.625	17.000	1.500	958
458454	52-560TA	F.F.	1-3/8	2-1/4	52	9.999	4.000	17.000	1.500	928

Material F.F. = ForgeFab

54" and larger diameters available on request.

## Finish bored sheaves

Wire Wrap: 180° contact around sheave.  
 Bearing: A wide range of bearing options available.  
 Surface Coating: Standard Enamel with or 2 or 3 coat marine system available upon request.  
 Hardening of Wire Groove: Flame hardened to a minimum 35 Rc. Concurrent hardening upon request.  
 Certificate: Certification according to ABS, API-8C, BV, CCS, DNVGL or Lloyds on request.

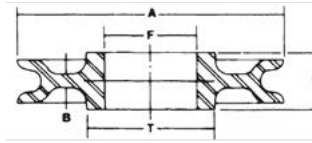

Art.number	Material	Wire Rope Size		A Nominal O.D. (inch)	F Hub bore (inch)	G Hub width (inch)	T Hub O.D. (inch)	B Web thick (inch)	Weight lb
		Min. (inch)	(Max. inch)						
3183	D.I.	1/2	1-1/8	14	2.4995/2.5005	2.000	4.500	-	23.5
5513	D.I.	1/2	1-1/8	14	2.5611/2.5621	1.750	4.500	-	22.5
5520	D.I.	1/2	1-1/8	14	2.999/3.000	2.000	4.500	-	34
3184	D.I.	1/2	1-1/8	14	3.2486/3.2496	2.000	4.500	-	35
3185	F.F.	1/2	1	16	2.4995/2.5005	2.000	3.750	.0750	46
5629	F.F.	1/2	7/8	16	2.9987/2.9997	2.000	4.750	.0750	49
3186	F.F.	1/2	1-1/8	16	3.2486/3.2496	2.000	4.750	.0750	48
3301	F.F.	1/2	1-1/8	16	2.7505/2.7515	2.500	3.750	.0750	48
3302	F.F.	1/2	1-1/4	16	3.4985/3.4995	2.500	4.750	.0750	48
5661	F.F.	1/2	1-1/8	16	3.7485/3.7495	2.500	4.750	.0750	47
6084	F.F.	1/2	1-1/8	16	3.999/4.000	2.500	5.500	.0750	47
4322	F.F.	1/2	1-1/8	16	4.4985/4.4995	2.375	5.500	.0750	46
6085	F.F.	1/2	1	16	4.4985/4.4995	2.500	5.500	.0750	47
4321	F.F.	1/2	1-1/8	16	4.4985/4.4995	2.750	5.500	.0750	47
1742	F.F.	1/2	7/8	18	2.999/3.000	2.000	4.750	.0750	61
1741	F.F.	1/2	3/4	18	3.2486/3.2496	2.000	4.750	.0750	59
5694	F.F.	1/2	1-1/4	18	3.4985/3.4995	2.500	4.750	.0750	59
5695	F.F.	1/2	1-1/8	18	3.7485/3.7495	2.500	4.750	.0750	59
5707	F.F.	1/2	1-1/8	18	3.999/4.000	2.500	5.500	.0750	61
5708	F.F.	1/2	1-1/8	18	4.4985/4.4995	2.500	5.500	.0750	59
5441	F.F.	1/2	1-1/8	18	4.4985/4.4995	2.375	5.500	.0750	58
4324	F.F.	1/2	1-1/8	18	5.9985/5.9999	2.375	7.500	.0750	59
4770	F.F.	1/2	1	18	6.4984/6.4999	2.250	8.500	.0750	61
5761	F.F.	1/2	1-1/8	20	3.4985/3.4995	2.500	4.750	.0750	73
5762	F.F.	1/2	1-1/8	20	3.7485/3.7495	2.500	4.750	.0750	72
5754	F.F.	1/2	1-1/8	20	3.999/4.000	2.500	5.500	.0750	74
5466	F.F.	1/2	1-1/8	20	4.4985/4.4995	2.375	5.500	.0750	72
5758	F.F.	1/2	1-1/8	20	4.4985/4.4995	2.500	5.500	.0750	72
4326	F.F.	1/2	1-1/8	20	5.9984/5.999	2.375	7.500	.0750	73
4325	F.F.	5/8	1-1/8	20	5.9984/5.999	2.750	7.500	.0750	75
4772	F.F.	1/2	1-1/8	20	6.4984/6.4999	2.250	8.500	.0750	74
5803	F.F.	5/8	1-1/4	24	3.4985/3.4995	2.500	4.750	.0750	102
5804	F.F.	5/8	1-1/8	24	3.7485/3.7495	2.500	4.750	.0750	103
5797	F.F.	5/8	1-1/8	24	3.999/4.000	2.500	5.500	.0750	105
4433	F.F.	5/8	1-1/8	24	4.4985/4.4995	2.375	5.500	.0750	102
5798	F.F.	5/8	1-1/8	24	4.4985/4.4995	2.500	5.500	.0750	101
4522	F.F.	5/8	1-1/8	24	5.9984/5.999	2.375	7.500	.0750	102
4521	F.F.	5/8	1-1/8	24	5.9984/5.999	2.750	7.500	.0750	104
5814	F.F.	5/8	1-3/8	24	6.4984/6.4999	2.250	8.500	.0750	105
4929	F.F.	5/8	1-1/8	24	6.497/6.498	3.375	8.500	.0750	112

Material: F.F. = ForgeFab D.I. = Cast Ductile Iron

54" and larger diameters available on request.

## Finish bored sheaves

Wire Wrap: 180° contact around sheave.  
 Bearing: A wide range of bearing options available.  
 Surface Coating: Standard Enamel with or 2 or 3 coat marine system available upon request.  
 Hardening of Wire Groove: Flame hardened to a minimum 35 Rc. Concurrent hardening upon request.  
 Certificate: Certification according to ABS, API-8C, BV, CCS, DNVGL or Lloyds on request.

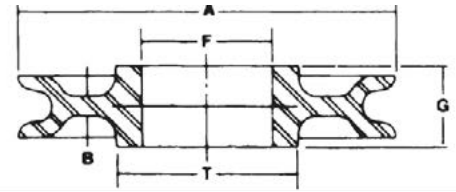

Art.number	Material	Wire Rope Size		A Nominal O.D. (inch)	F Hub bore (inch)	G Hub width (inch)	T Hub O.D. (inch)	B Web thick (inch)	Weight lb
		Min. (inch)	Max. (inch)						
4967	F.F.	5/8	1-1/8	26	5.9984/5.999	2.375	7.500	.0750	120
4966	F.F.	5/8	1-1/8	26	5.9984/5.999	2.750	7.500	.0750	121
4774	F.F.	5/8	1-1/8	26	5.9984/5.999	2.250	8.500	.0750	121
4931	F.F.	5/8	1-1/8	28	6.497/6.498	3.375	8.500	.0750	143
4249	F.F.	1-1/8	1-3/8	30	5.9984/5.999	2.375	7.500	1.000	208
4776	F.F.	1	1-3/8	30	6.4984/6.4999	2.250	8.500	1.000	208
4775	F.F.	1-1/4	1-1/2	30	8.873/8.874	3.750	11.500	1.250	269
4768	F.F.	1-1/8	1-3/8	34	5.9984/5.999	2.375	7.500	1.000	265
4771	F.F.	1-1/8	1-3/8	34	5.9984/5.999	2.750	7.500	1.000	266
4769	F.F.	1-1/4	1-3/8	34	6.4984/6.4999	2.250	8.500	1.000	259
4777	F.F.	1-3/8	1-1/2	36	8.873/8.874	3.750	11.500	1.250	373
4932	F.F.	1-3/8	2	42	8.873/8.874	3.500	11.500	1.500	595
4778	F.F.	1-3/8	2	42	8.873/8.874	3.750	11.500	1.500	600
4779	F.F.	1-3/8	2	48	8.873/8.874	3.750	11.500	1.500	626
4934	F.F.	1-3/8	2	52	10.872/10.873	3.625	14.000	1.500	918
1794	F.F.	1-3/8	2-1/4	52	12.871/12.873	4.500	17.000	1.500	938
1798	F.F.	1-3/8	2-1/4	52	13.6835/13.6855	4.000	17.000	1.500	906

Material: F.F. = ForgeFab

54" and larger diameters available on request.

## Sheaves with PD 18× steel wire rope diameter

These sheaves have a universal design for use onshore, offshore and subsea in adverse service conditions.

Wire Wrap:	180° contact around sheave.
Bearing:	Glide bearing or double row cylindrical roller bearing.
Surface Coating:	NORSOK M-501 System No. 1 with topcoat color RAL 1003 (Signal Yellow) with option for System No. 7 or other topcoat color on request.
Hardening of Wire Groove:	Induction hardening on request up to 54 RC.
Certificate:	Manufacturer work certificate acc. to DNV GL, Lloyds, ABS, BV or CCS.
Regulations:	European Machinery Directive.

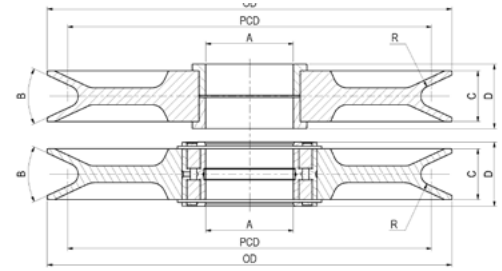

Art.number	Wire Rope Diameter (inch.)	Roller Bearing	R (inch.)	PD (inch.)	OD (inch.)	A (inch.)	B (°)	C (inch.)	D (inch.)		Weight (lb)	
									Roller Bearing	Glide Bearing	Roller Bearing	Glide Bearing
AS1020010001	3/8	5006-PP	0.209	7.09	7.9	1.181	50	0.95	1.34	1.34	7	9
AS1020010017	1/2	5008-PP	0.252	8.50	9.4	1.575	45	1.06	1.46	1.50	11	9
AS1020010018	9/16	5013-PP	0.291	9.92	11.0	2.559	50	1.34	1.97	1.81	18	15
AS1020010019	5/8	5015-PP	0.335	11.34	12.6	2.953	50	1.58	1.97	2.13	22	26
AS1020010020	11/16	5015-PP	0.374	12.76	14.2	2.953	50	1.58	1.97	2.13	29	31
AS1020010021	13/16	5016-PP	0.417	14.17	15.7	3.150	50	1.81	2.44	2.36	40	42
AS1020010022	7/8	5018-PP	0.461	15.59	17.3	3.543	50	2.01	2.40	2.64	51	53
AS1020010023	1	5020-PP	0.500	17.01	18.9	3.937	40	2.01	2.80	2.64	73	75
AS1020010024	1	5020-PP	0.543	18.43	20.5	3.937	40	2.01	2.80	2.64	75	79
AS1020010025	1 1/8	5026-PP	0.583	19.84	22.0	5.118	50	2.95	3.74	3.74	132	141
AS1020010026	1 3/16	5026-PP	0.626	21.26	23.6	5.118	50	2.95	3.74	3.74	154	163
AS1020010027	1 1/4	5028-PP	0.669	22.68	25.2	5.512	50	2.87	3.66	3.74	165	174
AS1020010028	1 3/8	5030-PP	0.709	24.09	26.8	5.906	40	3.03	3.82	3.94	203	212
AS1020010029	1 7/16	5030-PP	0.752	25.51	28.3	5.906	40	3.03	3.82	3.94	238	247
AS1020010116	1 1/2	5026-PP	0.795	26.93	29.9	5.118	30	2.95	3.74	3.74	229	209
AS1020010117	1 5/8	5028-PP	0.835	28.35	31.5	5.512	30	2.87	3.66	3.74	293	236
AS1020010118	1 5/8	5030-PP	0.878	29.76	33.1	5.906	30	3.03	3.82	3.94	335	344
AS1020010119	1 3/4	5030-PP	0.921	31.18	34.6	5.906	30	3.03	3.82	3.94	397	408
AS1020010120	1 3/4	5034-PP	0.961	32.60	36.2	6.693	40	3.82	4.61	4.80	408	414
AS1020010121	1 7/8	5034-PP	1.004	34.02	37.8	6.693	40	3.82	4.61	4.80	525	529
AS1020010122	2	5034-PP	1.043	35.43	39.4	6.693	30	3.82	4.61	4.80	613	617
AS1020010123	2	5036-PP	1.087	36.85	40.9	7.087	40	4.25	5.04	5.35	657	661
AS1020010124	2 1/8	5036-PP	1.130	38.27	42.5	7.087	40	4.25	5.04	5.35	776	780
AS1020010125	2 1/4	5036-PP	1.169	39.69	44.1	7.087	30	4.57	5.04	5.35	822	822
AS1020010126	2 1/4	5040-PP	1.213	41.10	45.7	7.874	30	4.57	5.35	5.91	899	913
AS1020010128	2 3/8	5040-PP	1.252	42.52	47.2	7.874	30	4.96	5.35	5.91	1065	1078
AS1020010130	2 1/2	5044-PP	1.295	43.94	48.8	8.661	30	4.96	5.75	6.30	1184	1199
AS1020010154	2 1/2	5048-PP	1.339	45.35	50.4	9.449	30	5.91	5.75	6.30	1290	1307
AS1020010155	2 5/8	5060-PP	1.378	46.77	52.0	10.236	40	5.91	6.69	7.48	1554	1574
AS1020010156	2 5/8	5060-PP	1.421	48.19	53.5	10.236	40	5.91	6.69	7.48	1574	1596
AS1020010157	2 3/4	5060-PP	1.461	49.61	55.1	10.236	40	5.91	6.69	7.48	1713	1733

Machined or cast ductile iron depending on quantity.



## Sheaves with PD 19x steel wire rope diameter

These sheaves have a universal design for use onshore, offshore and subsea in adverse service conditions.

Wire Wrap: 180° contact around sheave.  
 Bearing: Glide bearing or double row cylindrical roller bearing.  
 Surface Coating: NORSOK M-501 System No. 1 with topcoat color RAL 1003 (Signal Yellow) with option for System No. 7 or other topcoat color on request.  
 Hardening of Wire Groove: Induction hardening on request up to 54 RC.  
 Certificate: Manufacturer work certificate acc. to DNV GL, Lloyds, ABS, BV or CCS.  
 Regulations: European Machinery Directive.

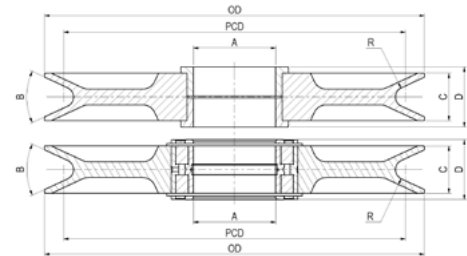

Art.number	Wire Rope Diameter (inch.)	Roller Bearing	R (inch.)	PD (inch.)	OD (inch.)	A (inch.)	B (°)	C (inch.)	D (inch.)				Weight (lb)	
									Roller Bearing	Glide Bearing	Roller Bearing	Glide Bearing	Roller Bearing	Glide Bearing
AS1020010258	3/8	5006-PP	0.209	7.48	8.3	1.181	50	0.95	1.34	1.34	9	9		
AS1020010259	1/2	5008-PP	0.252	8.98	9.9	1.575	45	1.06	1.46	1.50	11	11		
AS1020010260	9/16	5013-PP	0.291	10.47	11.6	2.559	50	1.34	1.97	1.81	18	20		
AS1020010261	5/8	5015-PP	0.335	11.97	13.2	2.953	50	1.58	1.97	2.13	22	29		
AS1020010262	11/16	5015-PP	0.374	13.46	14.9	2.953	50	1.58	1.97	2.13	29	31		
AS1020010263	13/16	5016-PP	0.417	14.96	16.5	3.150	50	1.81	2.44	2.36	40	42		
AS1020010264	7/8	5018-PP	0.461	16.46	18.2	3.543	50	2.01	2.40	2.64	51	53		
AS1020010265	1	5020-PP	0.500	17.95	19.8	3.937	40	2.01	2.80	2.64	71	73		
AS1020010266	1	5020-PP	0.543	19.45	21.5	3.937	40	2.01	2.80	2.64	77	82		
AS1020010267	1 1/8	5026-PP	0.583	20.94	23.1	5.118	50	2.95	3.74	3.74	126	132		
AS1020010268	1 3/16	5026-PP	0.626	22.44	24.8	5.118	50	2.95	3.74	3.74	137	141		
AS1020010269	1 1/4	5028-PP	0.669	23.94	26.5	5.512	50	2.87	3.66	3.74	159	165		
AS1020010270	1 3/8	5030-PP	0.709	25.43	28.1	5.906	40	3.03	3.82	3.94	192	194		
AS1020010271	1 7/16	5030-PP	0.752	26.93	29.8	5.906	40	3.03	3.82	3.94	225	229		
AS1020010272	1 1/2	5026-PP	0.795	28.43	31.4	5.118	30	2.95	3.74	3.74	251	258		
AS1020010273	1 5/8	5028-PP	0.835	29.92	33.1	5.512	30	2.87	3.66	3.74	287	295		
AS1020010274	1 5/8	5030-PP	0.878	31.42	34.7	5.906	30	3.03	3.82	3.94	362	368		
AS1020010275	1 3/4	5030-PP	0.921	32.91	36.4	5.906	30	3.03	3.82	3.94	395	403		
AS1020010276	1 3/4	5034-PP	0.961	34.41	38.0	6.693	40	3.82	4.61	4.80	445	445		
AS1020010277	1 7/8	5034-PP	1.004	35.91	39.7	6.693	40	3.82	4.61	4.80	494	503		
AS1020010278	2	5034-PP	1.043	37.40	41.3	6.693	30	3.82	4.61	4.80	589	600		
AS1020010279	2	5036-PP	1.087	38.90	43.0	7.087	40	4.25	5.04	5.35	644	655		
AS1020010280	2 1/8	5036-PP	1.130	40.39	44.6	7.087	40	4.25	5.04	5.35	694	705		
AS1020010281	2 1/4	5036-PP	1.169	41.89	46.3	7.087	30	4.57	5.04	5.35	838	849		
AS1020010282	2 1/4	5040-PP	1.213	43.39	48.0	7.874	30	4.57	5.35	5.91	970	990		
AS1020010283	2 3/8	5040-PP	1.252	44.88	49.6	7.874	30	4.96	5.35	5.91	1142	1160		
AS1020010284	2 1/2	5044-PP	1.295	46.38	51.3	8.661	30	4.96	5.75	6.30	1334	1354		
AS1020010285	2 1/2	5048-PP	1.339	47.87	52.9	9.449	30	5.91	5.75	6.30	1528	1548		
AS1020010286	2 5/8	5060-PP	1.378	49.37	54.6	10.236	40	5.91	6.69	7.48	1482	1506		
AS1020010287	2 5/8	5060-PP	1.421	50.87	56.2	10.236	40	5.91	6.69	7.48	1662	1687		
AS1020010288	2 3/4	5060-PP	1.461	52.36	57.9	10.236	40	5.91	6.69	7.48	1914	1938		

Machined or cast ductile iron depending on quantity.

## Sheaves with PD 20x steel wire rope diameter

These sheaves have a universal design for use onshore, offshore and subsea in adverse service conditions. This size is also suited for systems with heave compensation

Wire Wrap:	180° contact around sheave.
Bearing:	Glide bearing or double row cylindrical roller bearing.
Surface Coating:	NORSOK M-501 System No. 1 with topcoat color RAL 1003 (Signal Yellow) with option for System No. 7 or other topcoat color on request.
Hardening of Wire Groove:	Induction hardening on request up to 54 RC.
Certificate:	Manufacturer work certificate acc. to DNV GL, Lloyds, ABS, BV or CCS.
Regulations:	European Machinery Directive.

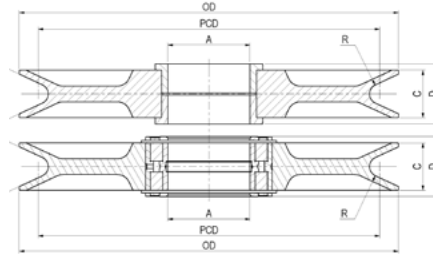

Art.number	Wire Rope Diameter (inch.)	Roller Bearing	R (inch.)	PD (inch.)	OD (inch.)	A (inch)	B (°)	C (inch.)	D (inch.)		Weight (lb)	
									Roller Bearing	Glide Bearing	Roller Bearing	Glide Bearing
AS1020010196	3/8	5006-PP	0.209	7.87	8.7	1.181	50	0.95	1.34	1.34	9	9
AS1020010197	1/2	5008-PP	0.252	9.45	10.4	1.575	45	1.06	1.46	1.50	11	15
AS1020010198	9/16	5013-PP	0.291	11.02	12.1	2.559	50	1.34	1.97	1.81	18	20
AS1020010199	5/8	5015-PP	0.335	12.60	13.9	2.953	50	1.58	1.97	2.13	26	29
AS1020010200	11/16	5015-PP	0.374	14.17	15.6	2.953	50	1.58	1.97	2.13	31	33
AS1020010201	13/16	5016-PP	0.417	15.75	17.3	3.150	50	1.81	2.44	2.36	44	49
AS1020010202	7/8	5018-PP	0.461	17.32	19.1	3.543	50	2.01	2.40	2.64	55	60
AS1020010203	1	5020-PP	0.500	18.90	20.8	3.937	40	2.01	2.80	2.64	73	75
AS1020010204	1	5020-PP	0.543	20.47	22.5	3.937	40	2.01	2.80	2.64	93	97
AS1020010205	1 1/8	5026-PP	0.583	22.05	24.3	5.118	50	2.95	3.74	3.74	148	154
AS1020010206	1 3/16	5026-PP	0.626	23.62	26.0	5.118	50	2.95	3.74	3.74	176	183
AS1020010207	1 1/4	5028-PP	0.669	25.20	27.7	5.512	50	2.87	3.66	3.74	185	192
AS1020010187	1 3/8	5030-PP	0.709	26.77	29.4	5.906	40	3.03	3.82	3.94	225	229
AS1020010208	1 7/16	5030-PP	0.752	28.35	31.2	5.906	40	3.03	3.82	3.94	269	276
AS1020010209	1 1/2	5026-PP	0.795	29.92	32.9	5.118	30	2.95	3.74	3.74	315	320
AS1020010210	1 5/8	5028-PP	0.835	31.50	34.6	5.512	30	2.87	3.66	3.74	346	353
AS1020010211	1 5/8	5030-PP	0.878	33.07	36.4	5.906	30	3.03	3.82	3.94	408	417
AS1020010212	1 3/4	5030-PP	0.921	34.65	38.1	5.906	30	3.03	3.82	3.94	448	456
AS1020010213	1 3/4	5034-PP	0.961	36.22	39.8	6.693	40	3.82	4.61	4.80	525	534
AS1020010214	1 7/8	5034-PP	1.004	37.80	41.6	6.693	40	3.82	4.61	4.80	584	593
AS1020010215	2	5034-PP	1.043	39.37	43.3	6.693	30	3.82	4.61	4.80	688	699
AS1020010216	2	5036-PP	1.087	40.94	45.0	7.087	40	4.25	5.04	5.35	736	747
AS1020010217	2 1/8	5036-PP	1.130	42.52	46.8	7.087	40	4.25	5.04	5.35	831	842
AS1020010218	2 1/4	5036-PP	1.169	44.09	48.5	7.087	30	4.57	5.04	5.35	948	959
AS1020010219	2 1/4	5040-PP	1.213	45.67	50.2	7.874	30	4.57	5.35	5.91	1118	1133
AS1020010220	2 3/8	5040-PP	1.252	47.24	52.0	7.874	30	4.96	5.35	5.91	1265	1283
AS1020010221	2 1/2	5044-PP	1.295	48.82	53.7	8.661	30	4.96	5.75	6.30	1382	1402
AS1020010222	2 1/2	5048-PP	1.339	50.39	55.4	9.449	30	5.91	5.75	6.30	1466	1486
AS1020010223	2 5/8	5060-PP	1.378	51.97	57.2	10.236	40	5.91	6.69	7.48	1693	1717
AS1020010224	2 5/8	5060-PP	1.421	53.54	58.9	10.236	40	5.91	6.69	7.48	1808	1832
AS1020010225	2 3/4	5060-PP	1.461	55.12	60.6	10.236	40	5.91	6.69	7.48	1989	2011

Machined or cast ductile iron depending on quantity.

## Sheaves with PD 22x steel wire rope diameter

These sheaves have a universal design for use onshore, offshore and subsea in adverse service conditions. This size is also suited for systems with heave compensation.

- Wire Wrap: 180° contact around sheave.
- Bearing: Glide bearing or double row cylindrical roller bearing.
- Surface Coating: NORSOK M-501 System No. 1 with topcoat color RAL 1003 (Signal Yellow) with option for System No. 7 or other topcoat color on request.
- Hardening of Wire Groove: Induction hardening on request up to 54 RC.
- Certificate: Manufacturer work certificate acc. to DNV GL, Lloyds, ABS, BV or CCS.
- Regulations: European Machinery Directive.

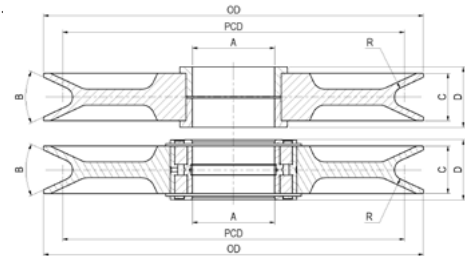

Art.number	Wire Rope Diameter (inch.)	Roller Bearing	R (inch.)	PD (inch.)	OD (inch.)	A (inch.)	B (°)	C (inch.)	D (inch.)		Weight (lb)	
									Roller Bearing	Glide Bearing	Roller Bearing	Glide Bearing
AS1020010226	3/8	5006-PP	0.209	8.66	9.4	1.181	50	0.95	1.34	1.34	9	9
AS1020010227	1/2	5008-PP	0.252	10.39	11.3	1.575	45	1.06	1.46	1.50	11	11
AS1020010228	9/16	5013-PP	0.291	12.13	13.2	2.559	50	1.34	1.97	1.81	24	24
AS1020010229	5/8	5015-PP	0.335	13.86	15.1	2.953	50	1.58	1.97	2.13	29	4
AS1020010230	11/16	5015-PP	0.374	15.59	17.0	2.953	50	1.58	1.97	2.13	37	37
AS1020010231	13/16	5016-PP	0.417	17.32	18.9	3.150	50	1.81	2.44	2.36	49	51
AS1020010232	7/8	5018-PP	0.461	19.06	20.8	3.543	50	2.01	2.40	2.64	64	66
AS1020010233	1	5020-PP	0.500	20.79	22.7	3.937	40	2.01	2.80	2.64	79	82
AS1020010234	1	5020-PP	0.543	22.52	24.6	3.937	40	2.01	2.80	2.64	95	97
AS1020010235	1 1/8	5026-PP	0.583	24.25	26.5	5.118	50	2.95	3.74	3.74	141	148
AS1020010236	1 3/16	5026-PP	0.626	25.98	28.3	5.118	50	2.95	3.74	3.74	174	179
AS1020010237	1 1/4	5028-PP	0.669	27.72	30.2	5.512	50	2.87	3.66	3.74	190	194
AS1020010238	1 3/8	5030-PP	0.709	29.45	32.1	5.906	40	3.03	3.82	3.94	229	231
AS1020010239	1 7/16	5030-PP	0.752	31.18	34.0	5.906	40	3.03	3.82	3.94	267	269
AS1020010240	1 1/2	5026-PP	0.795	32.91	35.9	5.118	30	2.95	3.74	3.74	306	313
AS1020010241	1 5/8	5028-PP	0.835	34.65	37.8	5.512	30	2.87	3.66	3.74	353	362
AS1020010242	1 5/8	5030-PP	0.878	36.38	39.7	5.906	30	3.03	3.82	3.94	419	428
AS1020010243	1 3/4	5030-PP	0.921	38.11	41.6	5.906	30	3.03	3.82	3.94	509	518
AS1020010244	1 3/4	5034-PP	0.961	39.84	43.5	6.693	40	3.82	4.61	4.80	582	591
AS1020010245	1 7/8	5034-PP	1.004	41.57	45.4	6.693	40	3.82	4.61	4.80	646	655
AS1020010246	2	5034-PP	1.043	43.31	47.2	6.693	30	3.82	4.61	4.80	805	814
AS1020010247	2	5036-PP	1.087	45.04	49.1	7.087	40	4.25	5.04	5.35	882	893
AS1020010248	2 1/8	5036-PP	1.130	46.77	51.0	7.087	40	4.25	5.04	5.35	950	963
AS1020010249	2 1/4	5036-PP	1.169	48.50	52.9	7.087	30	4.57	5.04	5.35	1221	1235
AS1020010250	2 1/4	5040-PP	1.213	50.24	54.8	7.874	30	4.57	5.35	5.91	1318	1336
AS1020010251	2 3/8	5040-PP	1.252	51.97	56.7	7.874	30	4.96	5.35	5.91	1526	1545
AS1020010252	2 1/2	5044-PP	1.295	53.70	58.6	8.661	30	4.96	5.75	6.30	1581	1601
AS1020010253	2 1/2	5048-PP	1.339	55.43	60.5	9.449	30	5.91	5.75	6.30	1823	1843
AS1020010254	2 5/8	5060-PP	1.378	57.17	62.4	10.236	40	5.91	6.69	7.48	2006	2030
AS1020010255	2 5/8	5060-PP	1.421	58.90	64.3	10.236	40	5.91	6.69	7.48	2145	2169
AS1020010256	2 3/4	5060-PP	1.461	60.63	66.1	10.236	40	5.91	6.69	7.48	2328	2357

Machined or cast ductile iron depending on quantity.

## Sheaves with PD 24× steel wire rope diameter

These sheaves have a universal design for use onshore, offshore and subsea in adverse service conditions. This size is also suited for systems with heave compensation.

Wire Wrap:	180° contact around sheave.
Bearing:	Glide bearing or double row cylindrical roller bearing.
Surface Coating:	NORSOK M-501 System No. 1 with topcoat color RAL 1003 (Signal Yellow) with option for System No. 7 or other topcoat color on request.
Hardening of Wire Groove:	Induction hardening on request up to 54 RC.
Certificate:	Manufacturer work certificate acc. to DNV GL, Lloyds, ABS, BV or CCS.
Regulations:	European Machinery Directive.

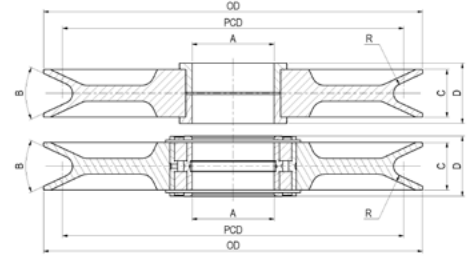

Art.number	Wire Rope Diameter (inch.)	Roller Bearing	R (inch.)	PD (inch.)	OD (inch.)	A (inch.)	B (°)	C (inch.)	D (inch.)				Weight (lb)	
									Roller Bearing	Glide Bearing	Roller Bearing	Glide Bearing	Roller Bearing	Glide Bearing
AS1020010440	3/8	5006-PP	0.209	9.45	10.2	1.181	50	0.95	1.34	1.34	11	11		
AS1020010441	1/2	5008-PP	0.252	11.34	12.3	1.575	45	1.06	1.46	1.50	18	18		
AS1020010442	9/16	5013-PP	0.291	13.23	14.3	2.559	50	1.34	1.97	1.81	26	29		
AS1020010443	5/8	5015-PP	0.335	15.12	16.4	2.953	50	1.58	1.97	2.13	40	42		
AS1020010444	11/16	5015-PP	0.374	17.01	18.4	2.953	50	1.58	1.97	2.13	53	55		
AS1020010445	13/16	5016-PP	0.417	18.90	20.5	3.150	50	1.81	2.44	2.36	73	73		
AS1020010446	7/8	5018-PP	0.461	20.79	22.5	3.543	50	2.01	2.40	2.64	95	95		
AS1020010447	1	5020-PP	0.500	22.68	24.6	3.937	40	2.01	2.80	2.64	128	130		
AS1020010448	1	5020-PP	0.543	24.57	26.6	3.937	40	2.01	2.80	2.64	148	152		
AS1020010449	1 1/8	5026-PP	0.583	26.46	28.7	5.118	50	2.95	3.74	3.74	225	229		
AS1020010450	1 3/16	5026-PP	0.626	28.35	30.7	5.118	50	2.95	3.74	3.74	249	254		
AS1020010451	1 1/4	5028-PP	0.669	30.24	32.8	5.512	50	2.87	3.66	3.74	280	287		
AS1020010452	1 3/8	5030-PP	0.709	32.13	34.8	5.906	40	3.03	3.82	3.94	342	351		
AS1020010453	1 7/16	5030-PP	0.752	34.02	36.9	5.906	40	3.03	3.82	3.94	390	397		
AS1020010454	1 1/2	5026-PP	0.795	35.91	38.9	5.118	30	2.95	3.74	3.74	452	459		
AS1020010455	1 5/8	5028-PP	0.835	37.80	40.9	5.512	30	2.87	3.66	3.74	516	522		
AS1020010456	1 5/8	5030-PP	0.878	39.69	43.0	5.906	30	3.03	3.82	3.94	604	613		
AS1020010457	1 3/4	5030-PP	0.921	41.57	45.0	5.906	30	3.03	3.82	3.94	688	694		
AS1020010458	1 3/4	5034-PP	0.961	43.46	47.1	6.693	40	3.82	4.61	4.80	814	825		
AS1020010459	1 7/8	5034-PP	1.004	45.35	49.1	6.693	40	3.82	4.61	4.80	915	924		
AS1020010460	2	5034-PP	1.043	47.24	51.2	6.693	30	3.82	4.61	4.80	1014	1023		
AS1020010461	2	5036-PP	1.087	49.13	53.2	7.087	40	4.25	5.04	5.35	1153	1080		
AS1020010462	2 1/8	5036-PP	1.130	51.02	55.3	7.087	40	4.25	5.04	5.35	1283	1294		
AS1020010463	2 1/4	5036-PP	1.169	52.91	57.3	7.087	30	4.57	5.04	5.35	1433	1444		
AS1020010464	2 1/4	5040-PP	1.213	54.80	59.4	7.874	30	4.57	5.35	5.91	1587	1607		
AS1020010465	2 3/8	5040-PP	1.252	56.69	61.4	7.874	30	4.96	5.35	5.91	1775	1792		
AS1020010466	2 1/2	5044-PP	1.295	58.58	63.5	8.661	30	4.96	5.75	6.30	1991	2011		
AS1020010467	2 1/2	5048-PP	1.339	60.47	65.5	9.449	30	5.91	5.75	6.30	2136	2158		
AS1020010468	2 5/8	5060-PP	1.378	62.36	67.6	10.236	40	5.91	6.69	7.48	2635	2657		
AS1020010469	2 5/8	5060-PP	1.421	64.25	69.6	10.236	40	5.91	6.69	7.48	2674	2696		
AS1020010470	2 3/4	5060-PP	1.461	66.14	71.7	10.236	40	5.91	6.69	7.48	2892	2917		

Machined or cast ductile iron depending on quantity.

## Sheaves with PD 25× steel wire rope diameter

These sheaves have a universal design for use onshore, offshore and subsea in adverse service conditions. This size is also suited for systems with heave compensation.

Wire Wrap: 180° contact around sheave.  
 Bearing: Glide bearing or double row cylindrical roller bearing.  
 Surface Coating: NORSOK M-501 System No. 1 with topcoat color RAL 1003 (Signal Yellow) with option for System No. 7 or other topcoat color on request.  
 Hardening of Wire Groove: Induction hardening on request up to 54 RC.  
 Certificate: Manufacturer work certificate acc. to DNV GL, Lloyds, ABS, BV or CCS.  
 Regulations: European Machinery Directive.

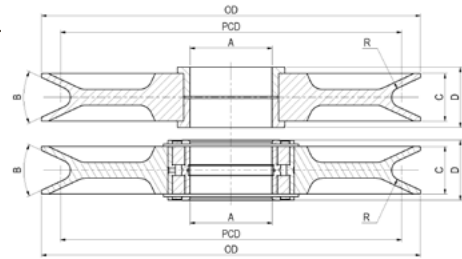

Art.number	Wire Rope Diameter (inch.)	Roller Bearing	R (inch.)	PD (inch.)	OD (inch.)	A (inch.)	B (°)	C (inch.)	D (inch.)				Weight (lb)	
									Roller Bearing	Glide Bearing	Roller Bearing	Glide Bearing	Roller Bearing	Glide Bearing
AS1020010370	3/8	5006-PP	0.209	9.84	10.6	1.181	50	0.95	1.34	1.34	15	15		
AS1020010371	1/2	5008-PP	0.252	11.81	12.8	1.575	45	1.06	1.46	1.50	22	11		
AS1020010372	9/16	5013-PP	0.291	13.78	14.9	2.559	50	1.34	1.97	1.81	33	33		
AS1020010373	5/8	5015-PP	0.335	15.75	17.0	2.953	50	1.58	1.97	2.13	44	49		
AS1020010374	11/16	5015-PP	0.374	17.72	19.1	2.953	50	1.58	1.97	2.13	64	66		
AS1020010375	13/16	5016-PP	0.417	19.69	21.3	3.150	50	1.81	2.44	2.36	88	93		
AS1020010376	7/8	5018-PP	0.461	21.65	23.4	3.543	50	2.01	2.40	2.64	121	121		
AS1020010377	1	5020-PP	0.500	23.62	25.5	3.937	40	2.01	2.80	2.64	150	152		
AS1020010378	1	5020-PP	0.543	25.59	27.6	3.937	40	2.01	2.80	2.64	190	194		
AS1020010379	1 1/8	5026-PP	0.583	27.56	29.8	5.118	50	2.95	3.74	3.74	271	276		
AS1020010380	1 3/16	5026-PP	0.626	29.53	31.9	5.118	50	2.95	3.74	3.74	317	326		
AS1020010381	1 1/4	5028-PP	0.669	31.50	34.0	5.512	50	2.87	3.66	3.74	340	348		
AS1020010382	1 3/8	5030-PP	0.709	33.46	36.1	5.906	40	3.03	3.82	3.94	397	406		
AS1020010383	1 7/16	5030-PP	0.752	35.43	38.3	5.906	40	3.03	3.82	3.94	463	472		
AS1020010384	1 1/2	5026-PP	0.795	37.40	40.4	5.118	30	2.95	3.74	3.74	536	540		
AS1020010385	1 5/8	5028-PP	0.835	39.37	42.5	5.512	30	2.87	3.66	3.74	615	624		
AS1020010386	1 5/8	5030-PP	0.878	41.34	44.6	5.906	30	3.03	3.82	3.94	717	725		
AS1020010387	1 3/4	5030-PP	0.921	43.31	46.8	5.906	30	3.03	3.82	3.94	825	831		
AS1020010388	1 3/4	5034-PP	0.961	45.28	48.9	6.693	40	3.82	4.61	4.80	948	957		
AS1020010389	1 7/8	5034-PP	1.004	47.24	51.0	6.693	40	3.82	4.61	4.80	1069	1080		
AS1020010390	2	5034-PP	1.043	49.21	53.1	6.693	30	3.82	4.61	4.80	1193	1202		
AS1020010391	2	5036-PP	1.087	51.18	55.3	7.087	40	4.25	5.04	5.35	1354	1365		
AS1020010392	2 1/8	5036-PP	1.130	53.15	57.4	7.087	40	4.25	5.04	5.35	1499	1510		
AS1020010393	2 1/4	5036-PP	1.169	55.12	59.5	7.087	30	4.57	5.04	5.35	1658	1669		
AS1020010394	2 1/4	5040-PP	1.213	57.09	61.7	7.874	30	4.57	5.35	5.91	1841	1861		
AS1020010395	2 3/8	5040-PP	1.252	59.06	63.8	7.874	30	4.96	5.35	5.91	2059	2079		
AS1020010396	2 1/2	5044-PP	1.295	61.02	65.9	8.661	30	4.96	5.75	6.30	2266	2286		
AS1020010397	2 1/2	5048-PP	1.339	62.99	68.0	9.449	30	5.91	5.75	6.30	2465	2487		
AS1020010398	2 5/8	5060-PP	1.378	64.96	70.2	10.236	40	5.91	6.69	7.48	2862	2886		
AS1020010399	2 5/8	5060-PP	1.421	66.93	72.3	10.236	40	5.91	6.69	7.48	3102	3126		
AS1020010400	2 3/4	5060-PP	1.461	68.90	74.4	10.236	40	5.91	6.69	7.48	3358	3382		

Machined or cast ductile iron depending on quantity.

# Lashing Components

Chain Tensioner • Other Lashing Products



**GUNNEBO**  
Industries

## Lashing Components

Chain Tensioner, GT	8:2 - 8:4
Chain	8:4
Midgrab MIG	8:4
Grab Hook GG with Locking Pin	8:5
Sling Hook	8:5
Safety Hook	8:5
Weldable Lifting Point	8:5
Screw-on Lifting Point	8:5



**WARNING:**  
Failure to read, understand and comply with the instructions, working load limits and specifications in this publication may result in serious injury or damage to property.

# Chain Tensioner - GT

The GT chain tensioner from Gunnebo Industries is integral in one set. It is made of high strength Grade 10 material and the ratchet handle contributes to a fast and ergonomic lashing procedure. The GT is fitted with safety pins to prevent unintended release of the threaded end fittings.

GT has 25% increased Lashing Capacity (LC) compared to Grade 80 lashings and high Standard Tension force (STF) thanks to the unique ratchet handle, and 43% increase LC compared to a grade 70 lashing system.

Our chain tensioner is designed to be compatible with the GrabiQ product range, enabling the choice of robust end-hooks with latches. Can also be provided as approved for lifting purposes.

See website or user instructions for assembly instructions.

Meets listed current specifications and standards at time of publication of this catalogue.



## Unique Benefits with our Chain Tensioner



### Short Handle

- Fully protected ratched mechanism with 8 steps per 90 degree pull, enabling use in very narrow spaces.
- Easy to change direction.
- The rubber handle decreases the risk of slipping and is convenient in cold climates.

### Open Design

- For easier and faster cleaning and lubrication.
- Allows dirt to fall through instead of building up.
- Two drain holes in the body prevent water residue.

### Trapezoidal Thread

- Makes the thread less sensitive to dirt and particles.
- Low-friction treated for trouble free operation.
- Makes lashing faster.
- Safety pins prevents unintended unwinding.



# Chain Lashing System

Gunnebo Industries offers a complete chain lashing system approved according to EN 12195-3. The system has been developed with focus on the user's needs and working environment, and with safety as highest priority. The unique Midgrab chain shortener saves valuable time and effort, and is a natural part of an efficient and effective chain lashing system.

GT Chain Lashing System offers 25% increased Lashing Capacity (LC) compared to Grade 80 lashings, and 43% increased capacity compared to Grade 70 lashings.

## End Fitting

Lashing hooks in grade 10, such as the EGKN Sling Hook with a heavy duty latch or the GBK Griplatch Safety Hook. Marked with positive indication of the manufacturer, product designation, size, batch number and grade.

## ID-tag

The ID-tag must state the lashing standard, capacity, tension force, traceability and name of manufacturer. It must also clearly say that the set is for lashing only, lifting is prohibited

## Shortening Function

The Midgrab offers instant mounting on any part of the chain, with the ability to shorten the chain in either direction. It is designed to prevent the chain from disengaging. Marked with positive indication of the manufacturer, product designation, size, batch number and grade.

## Chain

Gunnebo Industries high tensile short link chain. Surface treatment: Powder coated. ID-marking of the chain: 10G

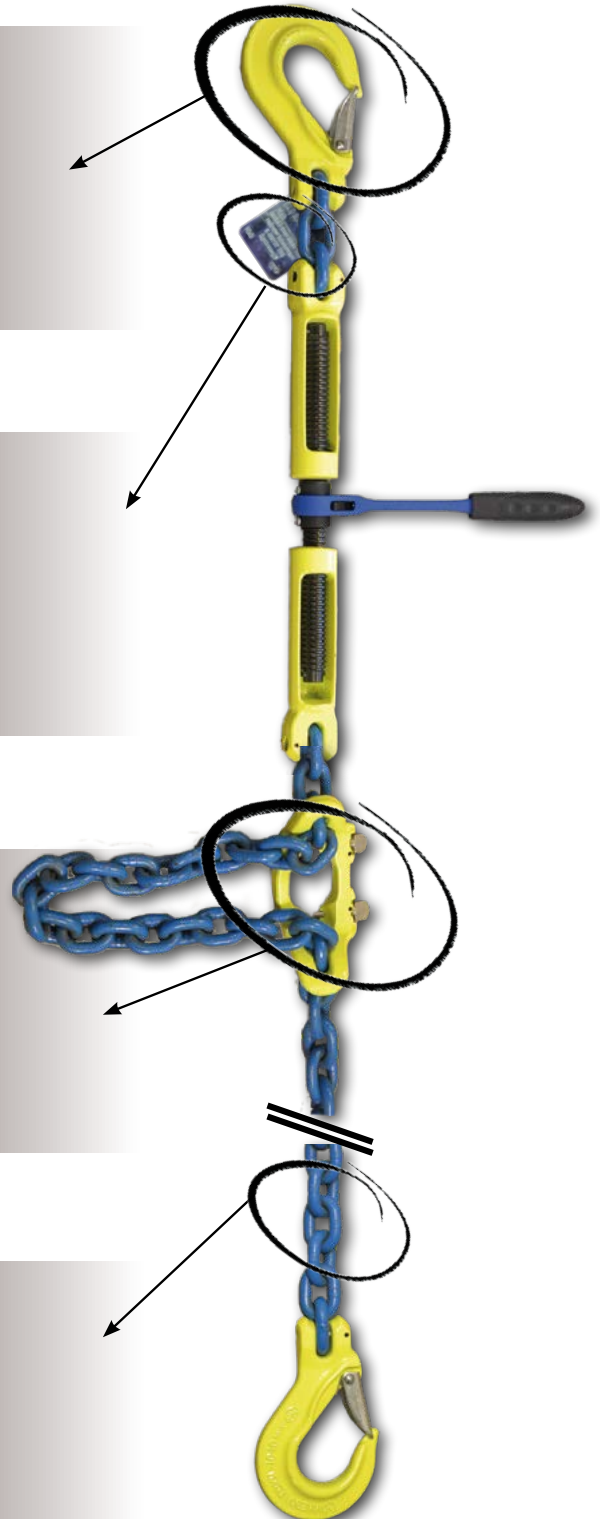

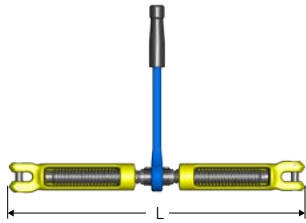

## Chain Tensioner GT

Art. no	Model	Lashing capacity (lb)	L = Min. length	L = Max. length	Weight (lb)
Z101336	GT-8-10	11 240	15.75	23.62	7.28
Z101337	GT-10-10	17 984	15.75	23.62	7.28

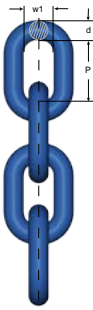

## Chain, GrabiQ Grade 10 (200)

Short link, KL

Art. no.	Code	WLL lb*	Lashing capacity (lb)	d nom.	P	w1	Weight lb/foot	MPF kN
Z802301	KLA-8-10	5 700	11 240	0.31	0.94	0.43	0.94	63
Z802302	KLA-10-10	8 800	17 984	0.39	1.18	0.55	1.55	98

Fulfills the requirements in ASTM A973/A973M-07(2012) EN 818+2:2008 (WLL +25%, reduced temperature range).

See our Full Range of Chain in Chapter 5

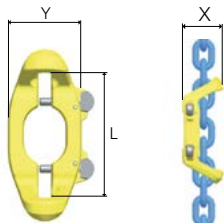

## Midgrab MIG with locking pins

Art. no.	Code	WLL lb*	Lashing capacity (lb)	L	X	Y	Weight lb
B14303	MIG CC-8-10	5 700	25 178	3.74	1.97	2.36	1.54
B14313	MIG CC-10-10	8 800	39 565	4.92	2.76	3.03	2.43

**Complete set for Lashing GT**  
with chain, hooks and MIG Shortener



**Lashing GT**  
with GG hooks



**Lashing Chain GrabiQ**  
with hooks in both ends



## Grab Hook GG with Locking Pin

Clevis shortening hook with locking pin for extra safety. No reduction of working load limit, thanks to supporting cradle lugs on either side of hook to prevent chain link deformation.

Art. no.	Code	WLL lb*	Lashing capacity (lb)	L	B	Weight lb
B14971	GG-8-10 LP	5 700	25 178	2.24	0.39	0.88
B14972	GG-10-10 LP	8 800	38 666	3.03	0.47	1.98
B14973	GG-13-10 LP	15 000	65 866	3.82	0.63	4.19
B14974	GG-16-10 LP	22 600	100 036	4.49	0.79	7.05

Fulfills requirements in: EN 1677:2008 (WLL +25%), ASTM A952/A952M and AS 3776:2015.

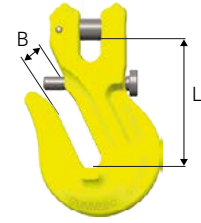

## Sling Hook EGKN

Sling hook with latch.

Art. no.	Code	WLL lb*	Lashing capacity (lb)	L	B	G	H	Weight lb
B14461	EGKN-8-10	5 700	25 178	3.74	1.10	0.67	0.91	1.10
B14462	EGKN-10-10	8 800	38 666	4.76	1.38	0.91	1.22	2.20

Fulfills requirements in: EN 1677:2008 (WLL +25%), ASTM A952/A952M and AS 3776:2015.

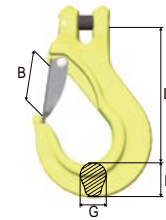

## Safety Hook GBK

Safety hook with clevis connector and grab latch.

Art. no.	Code	WLL lb*	Lashing capacity (lb)	L	B	G	H	Weight lb
Z100759	GBK-8-10	5 700	25 178	51	1.42	0.79	0.87	1.76
Z100760	GBK-10-10	8 800	38 666	78	1.85	0.87	1.14	3.09

Fulfills requirements in: EN 1677:2008 (WLL +25%), ASTM A952/A952M and AS 3776:2015.

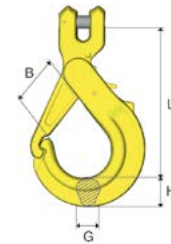

## Weldable Lifting Point WLP

Art. no.	Code	WLL lb*	Lashing capacity (lb)	B	D	G	L	R	X	Weight lb
Z7009001	WLP-2.5T	5 510	24 278	1.97	0.55	1.06	2.09	0.94	3.74	1.10
Z7009011	WLP-4T	8 800	38 666	2.28	0.67	1.34	1.89	1.14	3.82	1.76
Z7009021	WLP-7T	15 428	67 890	2.52	0.87	1.61	2.87	1.30	5.31	3.97
Z7009031	WLP-10T	22 040	97 114	2.56	1.06	2.05	2.87	1.50	5.98	7.50
Z7009041	WLP-16T	35 300	155 112	3.54	1.26	2.60	4.13	1.97	7.99	18.74

Supplied with spring for stay up function.

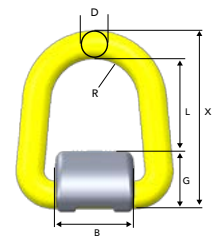

## Screw-on Lifting Point SLP

Art. no.	Code	WLL lb*	B	C	H	L	M metric thread	X	Bolt protrusion	Weight lb
Z7009881	SLP-1T	2 204	1.97	2.83	3.86	2.13	M14	5.47	0.98	1.76
Z7009871	SLP-3T	6 612	2.28	3.31	4.49	1.93	M16	5.67	1.10	2.87
Z7009861	SLP-5T	11 020	2.52	4.57	6.30	2.80	M20	7.99	1.34	5.73

Supplied with spring for stay up function.  
Bolt according to: ISO 898-1 Class 10.9.

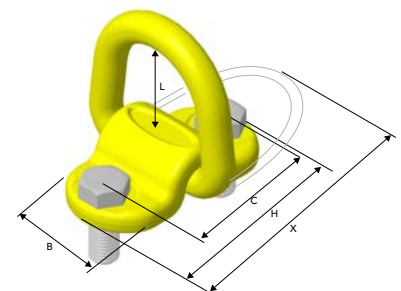









# Contact Information

## Gunnebo Industrier AB

Tel: +46 21 83 82 00

E-mail: [export@gunneboindustries.com](mailto:export@gunneboindustries.com)

Website: [www.gunneboindustries.com](http://www.gunneboindustries.com)

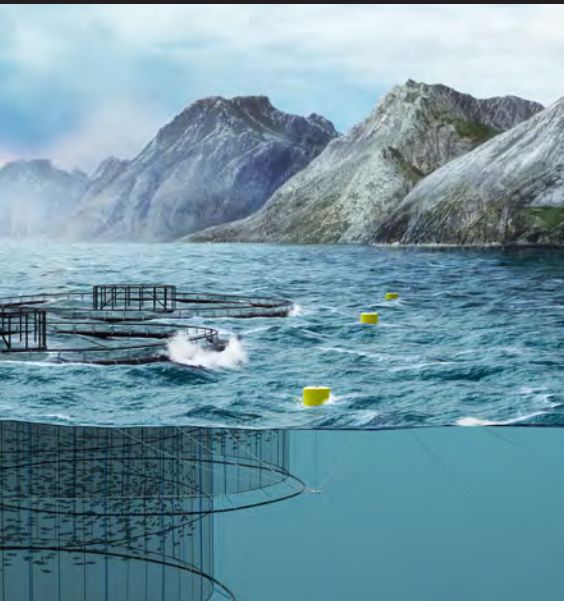

## Sales Offices

### Gunnebo Industries Pty Ltd, AUSTRALIA

Tel: +61 7 3451 0900

E-mail: [general.info@gunneboindustries.com.au](mailto:general.info@gunneboindustries.com.au)

### Gunnebo Industries Sp. z o.o, POLAND

Tel: +48 55 24 22 010

E-mail: [zawiesia@gunneboindustries.pl](mailto:zawiesia@gunneboindustries.pl)

### Gunnebo Industries Co. LTD, P.R of CHINA

Tel: +86 512 5525 2200

E-mail: [info@gunnebolifting.cn](mailto:info@gunnebolifting.cn)

### Gunnebo Industries Ltda, SOUTH AMERICA

Tel: +55 11 4055 9800

E-mail: [vendas@gunneboindustries.com.br](mailto:vendas@gunneboindustries.com.br)

### Gunnebo Industries GmbH, GERMANY

Tel: +49 273 989 720

E-mail : [info@gunneboindustries.de](mailto:info@gunneboindustries.de)

### Gunnebo Industrier AB, SWEDEN

Tel: +46 31 764 37 00

E-mail: [gbg@gunneboindustries.com](mailto:gbg@gunneboindustries.com)

### Gunnebo Industries, Inc. NORTH AMERICA

Tel: +1 918 832 8933

E-mail: [sales@gjcorp.com](mailto:sales@gjcorp.com)

### Gunnebo Industries Ltd, UNITED KINGDOM

Tel: +44 152 752 2560

E-mail: [sales@gunneboindustries.co.uk](mailto:sales@gunneboindustries.co.uk)

### Gunnebo Anja Industrier AS, NORWAY

Tel: +47 561 933 00

E-Mail: [sales@gunneboindustrier.no](mailto:sales@gunneboindustrier.no)



Art. no: 53959 - May 2019

